

REF:NS:SEC:
29th April, 2024

National Stock Exchange of India Limited
"Exchange Plaza", 5th Floor,
Plot No.C/1, G Block
Bandra-Kurla Complex
Bandra (East), Mumbai 400051.

BSE Limited
Phiroze Jeejeebhoy Towers,
Dalal Street, Fort,
Mumbai 400001.

Bourse de Luxembourg
Societe de la Bourse de Luxembourg
Societe Anonyme/R.C.B. 6222,
B.P. 165, L-2011 Luxembourg.

London Stock Exchange Plc
10 Paternoster Square
London EC4M 7LS.

Sub: Updated Press Release and Presentation - Launch of XUV 3XO Compact SUV

This is further to our letter bearing REF:NS:SEC dated 29th April, 2024 wherein we had given you intimation of the **Launch of XUV 3XO Compact SUV** along with the Web Links where Digital Feeds of the Product Launch Event would be available.

In this connection, please find attached a Presentation which was made at the Launch Event alongwith an Updated Press Release giving details of Pricing of all the Variants of the Product being launched.

The aforesaid Presentation would also be available on the website of the Company at <https://www.mahindra.com/investors/reports-and-filings> under 'Events update'.

Yours faithfully,
For MAHINDRA & MAHINDRA LIMITED

NARAYAN SHANKAR
COMPANY SECRETARY

Encl.: a/a

SAFETY INSTRUCTIONS

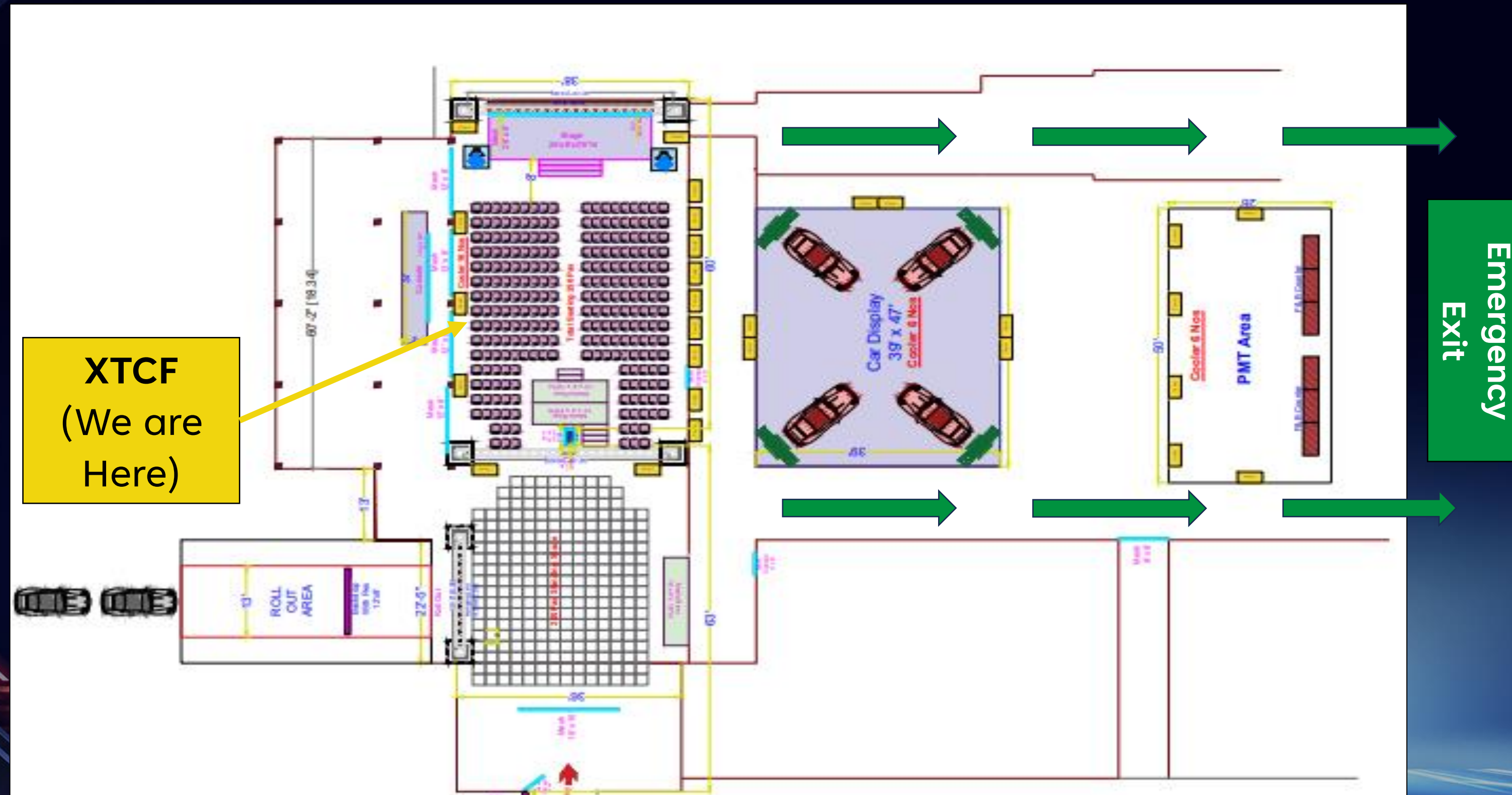

**Emergency Assembly Point
Is Outside The Shop**



- This Is No Smoking Plant.
- Emergency Exit Is On Your Right Side.
- In Case Of Emergency Do Not Panic.
- Stay Only In Event Designated Area.

BRAND PURPOSE



SPORT UTILITY VEHICLES

BRAND PURPOSE
SPORTS UTILITY VEHICLES

EXPLORE THE IMPOSSIBLE

LIFE IS AN ADVENTURE; LIVE IT BOLDLY WHILE CARING FOR OUR PLANET.

OUR AGILE, BOLD, AND COLLABORATIVE PEOPLE CREATE SOPHISTICATED AND AUTHENTIC* SUVS WITH SUSTAINABLE, INNOVATIVE TECHNOLOGIES THAT INSPIRE YOUR SPIRIT OF EXPLORATION

mahindra Rise

XUV 3X0

AV

6 PILLARS

STANDOUT DESIGN

SUV COMMAND SEATING

SAFE COCOON

DRIVE OF YOUR LIFE

RIDE OF YOUR LIFE

SPACE WHERE IT COUNTS

6 PILLARS

STANDOUT DESIGN

SUV COMMAND SEATING

SAFE COCOON

DRIVE OF YOUR LIFE

RIDE OF YOUR LIFE

SPACE WHERE IT COUNTS

6 PILLARS

STANDOUT DESIGN

SUV COMMAND SEATING

SAFE COCOON

DRIVE OF YOUR LIFE

RIDE OF YOUR LIFE

SPACE WHERE IT COUNTS

SUV COMMAND SEATING

Command seating position with Eye Level
1398 mm above the ground

Best-in-class forward visibility

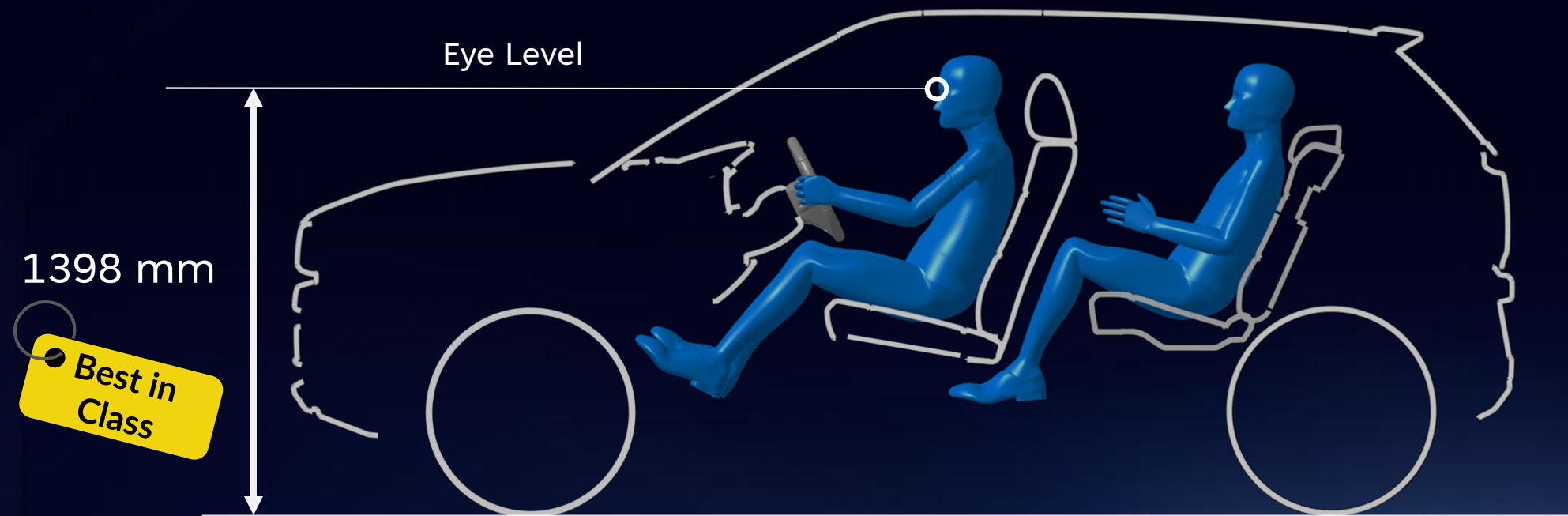

Forward visibility angle of XUV 3X0 matches with XUV 700 !

Parameter	XUV 3X0	#1 Player	#2 Player
Eye Point to Ground (mm)	1398	1397	1391
Forward visibility (deg)	23.7°	19.7°	21.5°

REAL SUV

Approach angle of XUV 3X0 matches with XUV 700 !

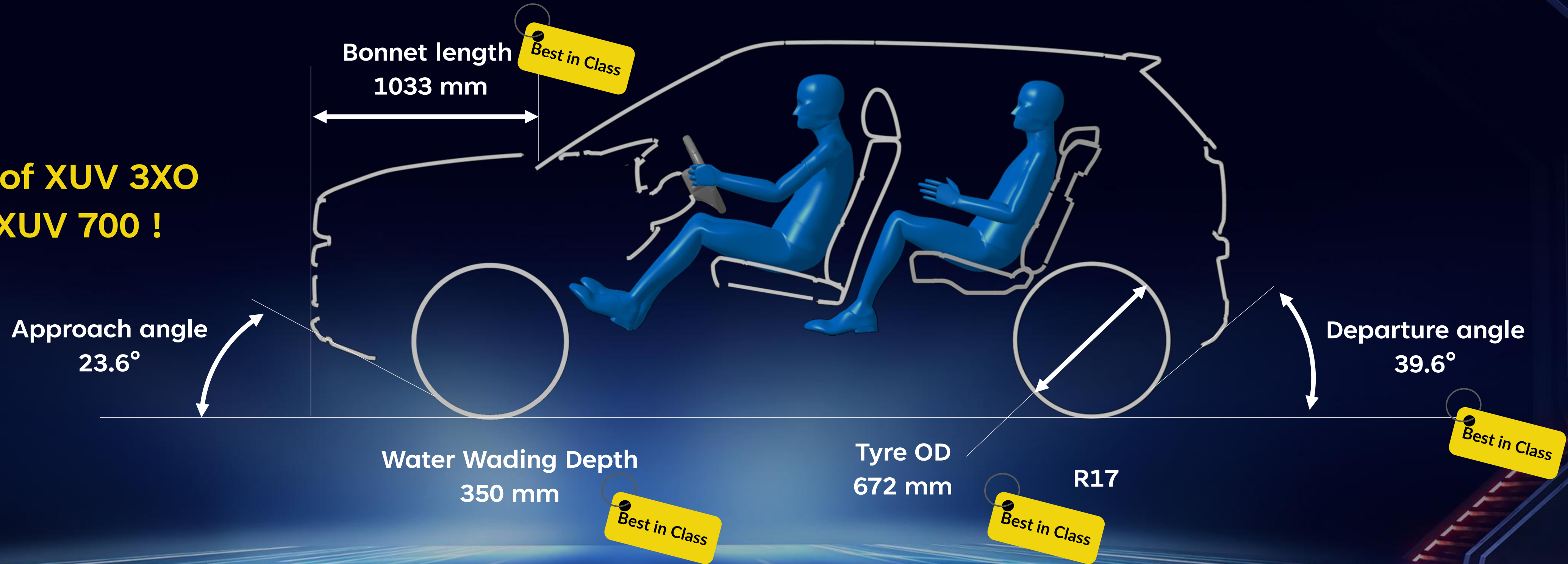

6 PILLARS

STANDOUT DESIGN

SUV COMMAND SEATING

SAFE COCOON

DRIVE OF YOUR LIFE

RIDE OF YOUR LIFE

SPACE WHERE IT COUNTS

SAFE COCOON

ENGINEERED FOR BEST-IN-CLASS SAFETY RATING

- Impact force : 20 ton (200 kN) at 64 kmph
- Designed to protect against peak deceleration ~ 38 g
- Frontal crash energy absorption : 276 kJ

- Reinforced side crash structure
- Designed to protect against side crash energy : 72 kJ

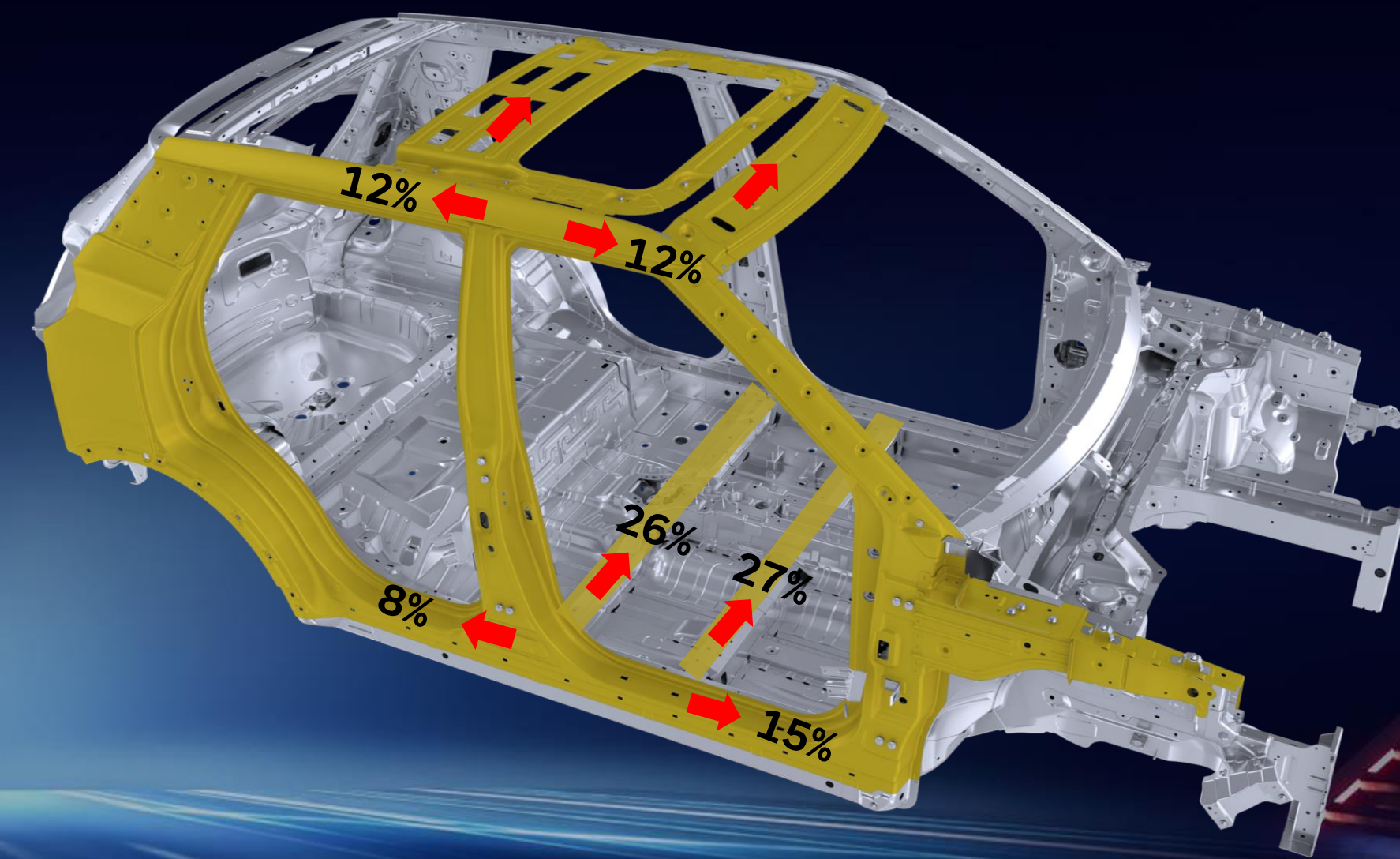
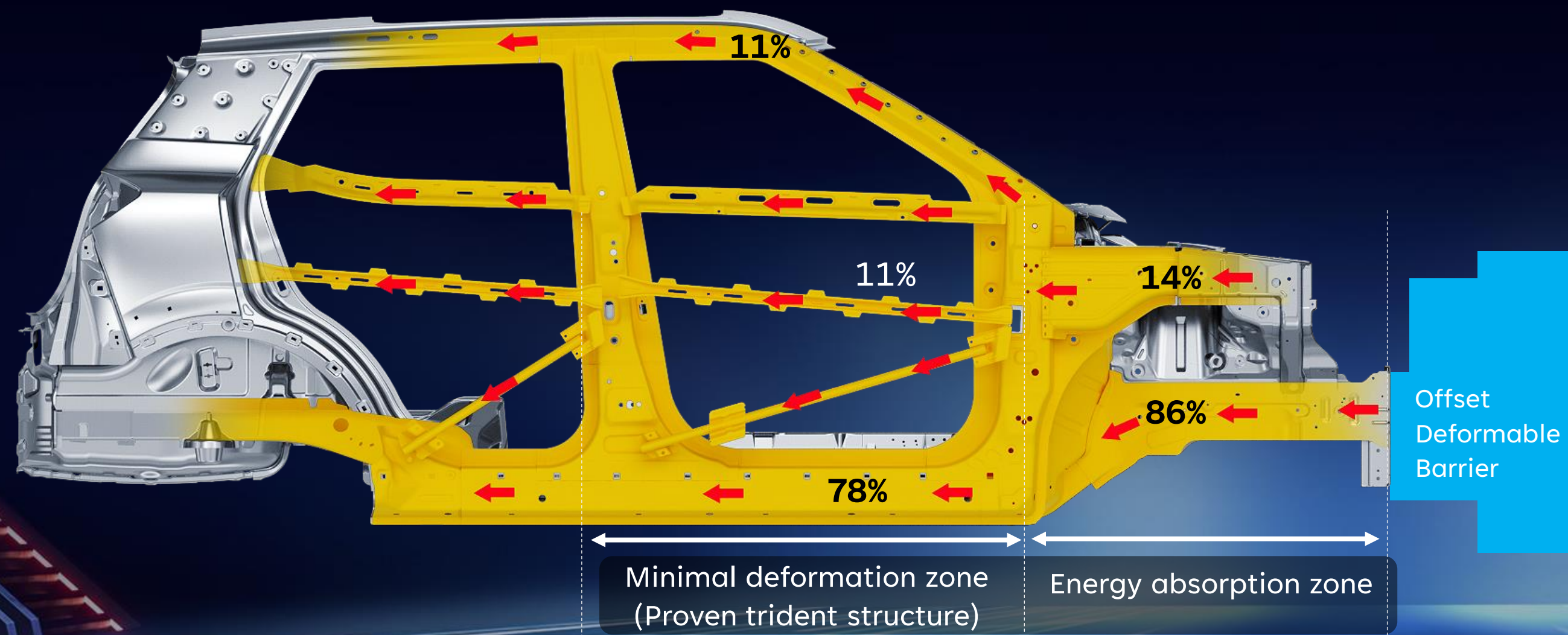

SAFE COCOON

UNPARALLELED STRENGTH WITH EXTENSIVE USE OF
HIGH STRENGTH STEEL

45% of total weight is
High Strength Steel or above

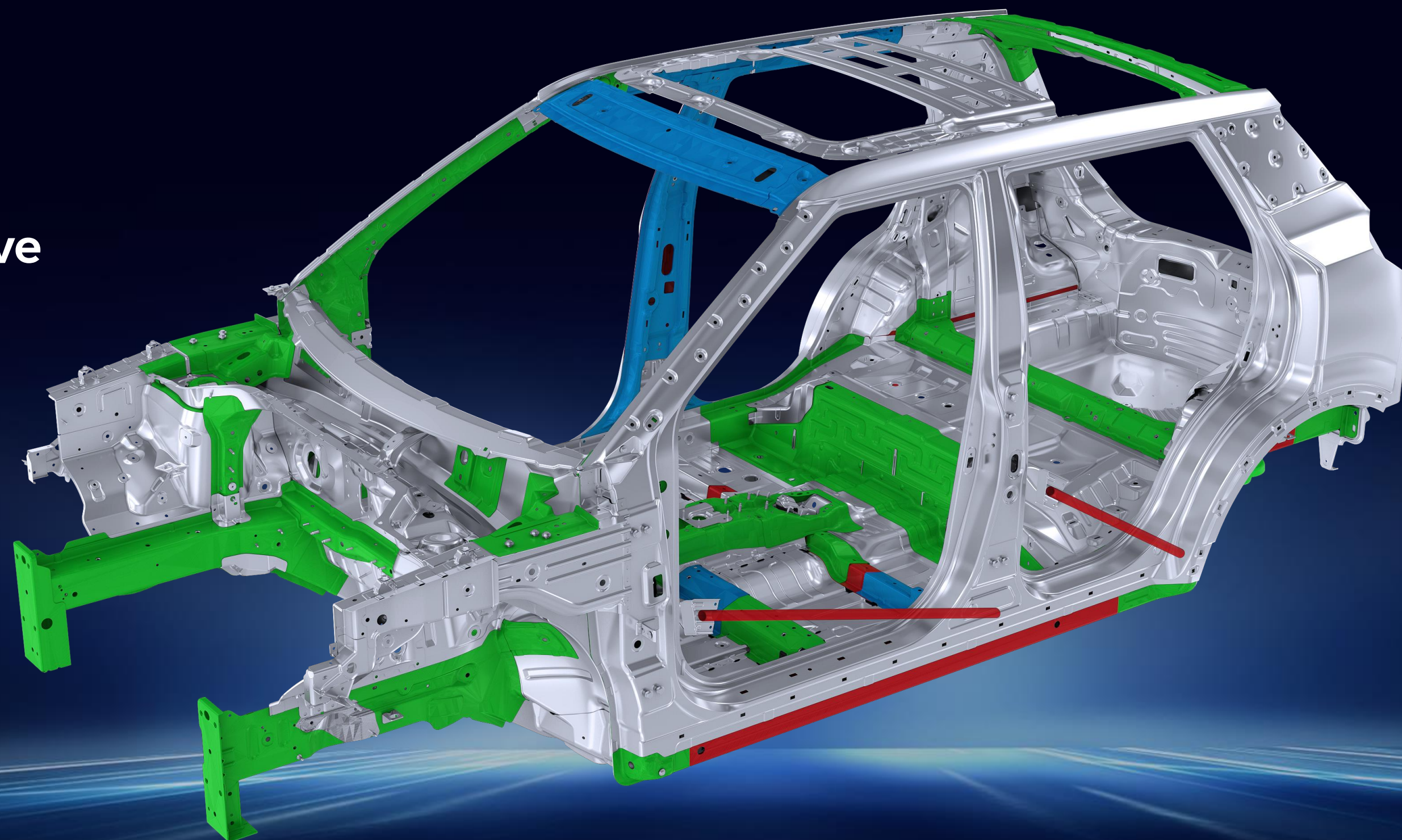

■ UHSS (UTS > 1500 Mpa)	: 10%
■ AHSS (UTS > 600 Mpa)	: 5%
■ HSS (UTS > 400 Mpa)	: 30%

SAFE COCOON

BIW STIFFNESS & SOLIDITY

Torsional stiffness
13.6 kNm/deg

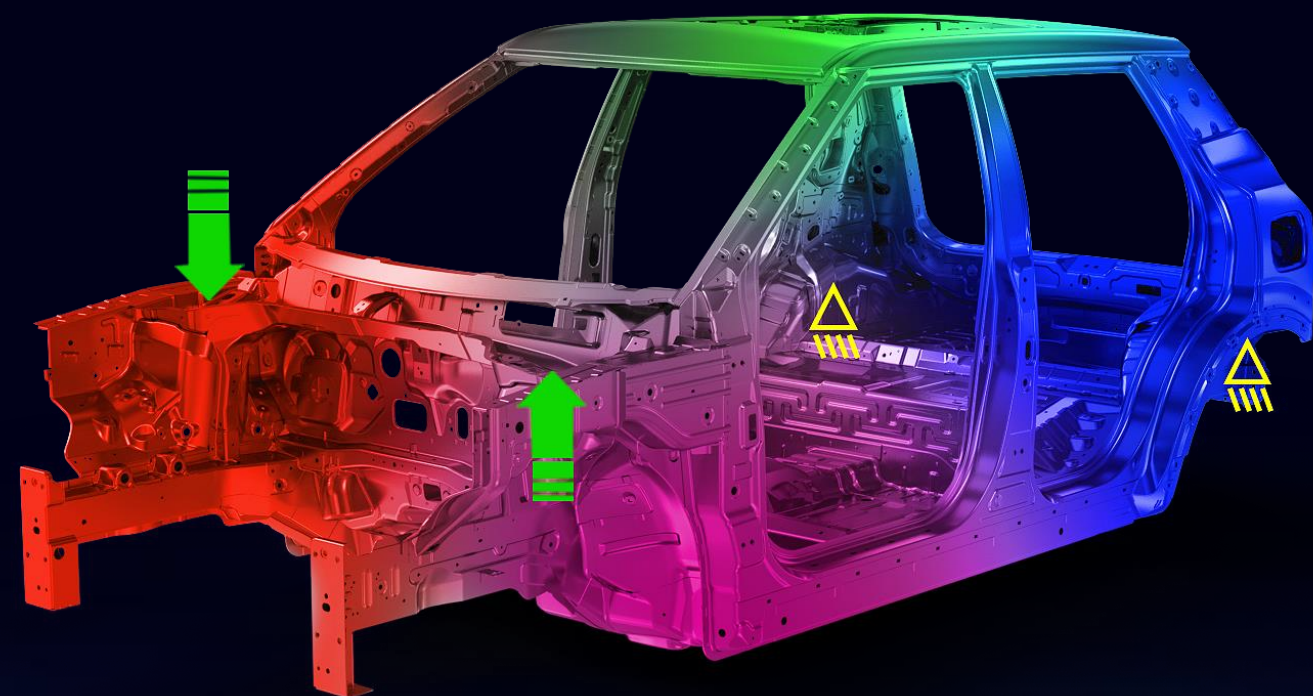

Bending stiffness
9.0 kN/mm

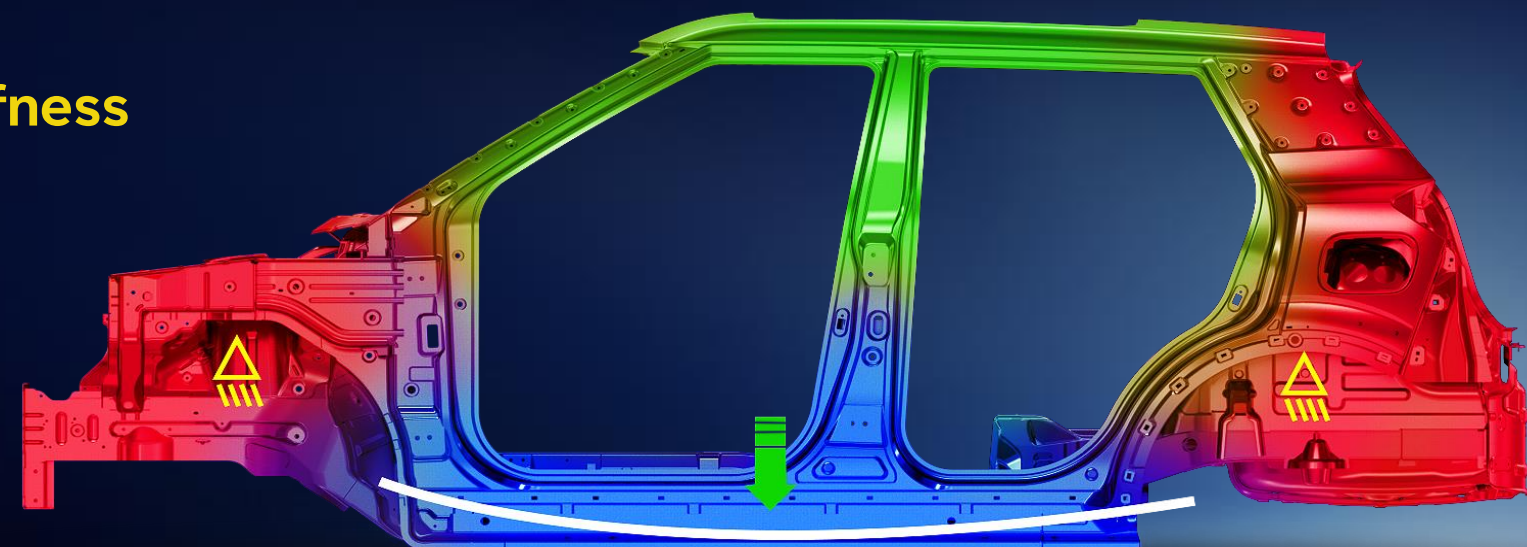

Enhanced Joinery Optimization



5328 Spot welds

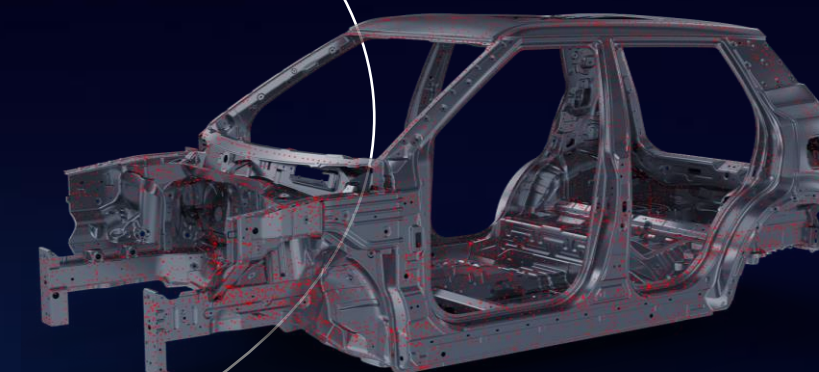

Robust Ring Structure

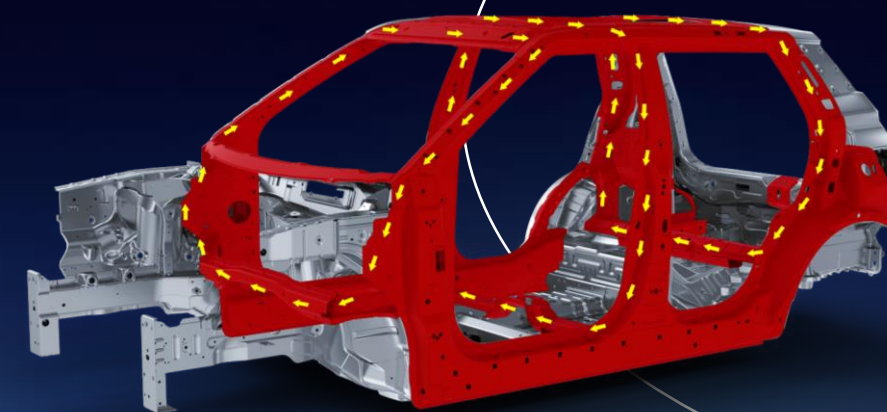

- Maximum stiffness
- Minimum weight

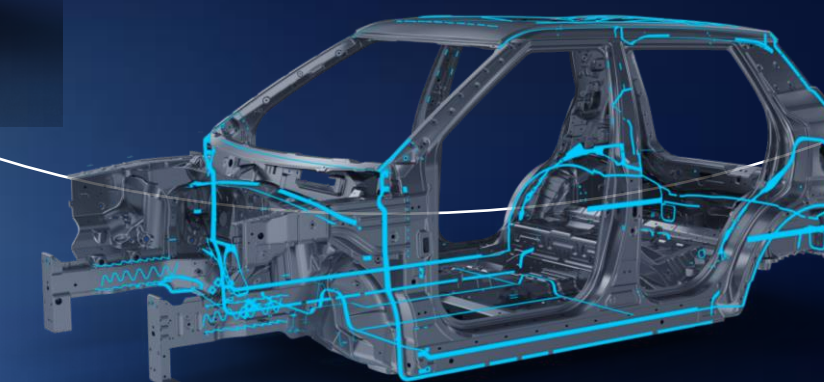

45m length structural sealer

SAFE COCOON

35

STANDARD SAFETY FEATURES



- 6 Airbags
- 4 Disc Brakes
- 3-point seat belt for all seats
- Seat-belt reminders for all seats
- Passenger airbag ON/OFF for child safety
- ISO-FIX child seats with top-tether

SAFE COCOON

COMPREHENSIVE ESP PACKAGE

ESP 9.3 system with improved BLDC motor
Enhanced braking performance & Stability



Time to lock (TTL) < 500 ms @ 0.9 g

Dynamic Safety Functions

- Vehicle Dynamics Control (VDC)
- Traction Control System (TCS)
- Roll Over Mitigation (ROM)

Other Value-add Functions

- Hill Hold Control (HHC)
- Hill Descent Control (HDC)
- Brake Disc Wiping (BDW)
- Electronic Brake Prefill (EBP)

ESP technology of XUV 3XO is same as XUV 700 !

6 PILLARS

STANDOUT DESIGN

SUV COMMAND SEATING

SAFE COCOON

DRIVE OF YOUR LIFE

RIDE OF YOUR LIFE

SPACE WHERE IT COUNTS

DRIVE OF YOUR LIFE

WORLD-CLASS TURBOCHARGED ENGINES

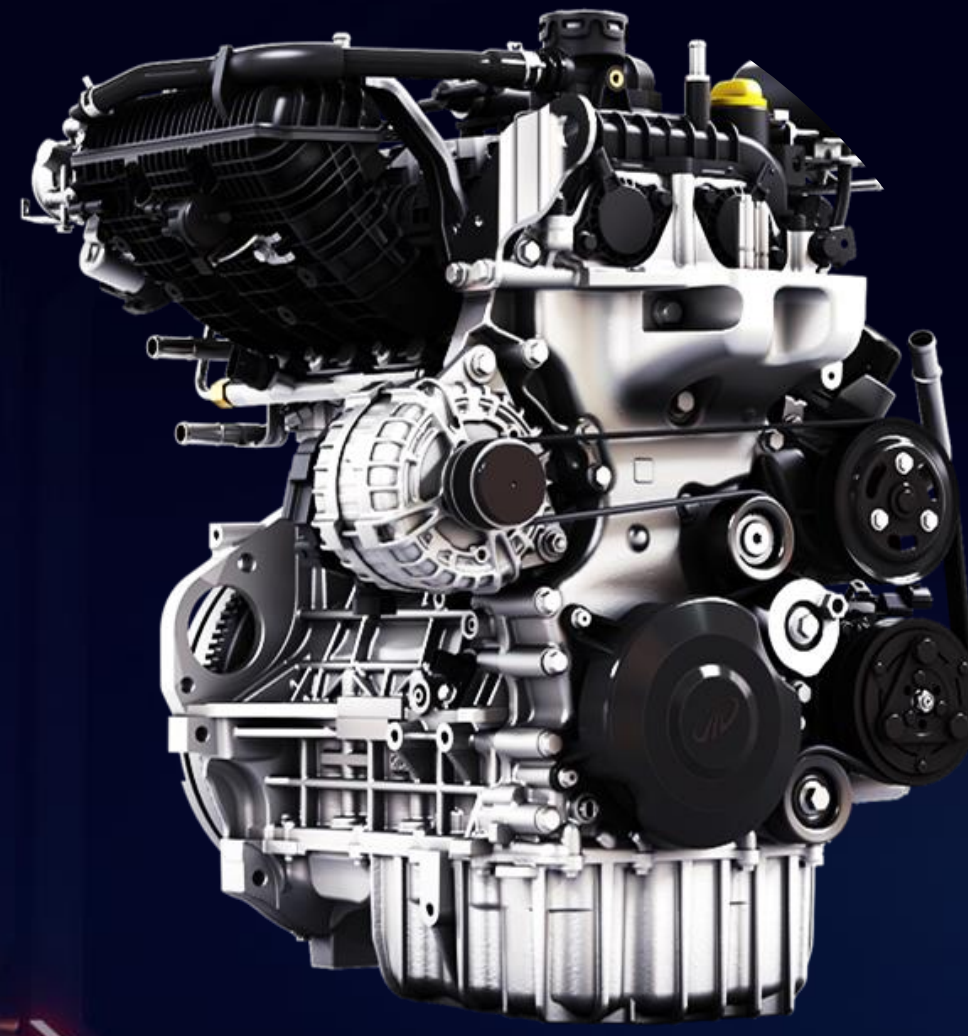

mStallion G12 TGD i & Turbocharged MPFI Engine

- **96 kW (130 PS) @ 5000 rpm**
- **230 Nm @ 1500 – 3750 rpm**
- **Overboost up to 250 Nm (AT)**



D15 VGT Common Rail

- **85.8 kW (117 PS) @ 3750 rpm**
- **300 Nm @ 1500 – 2500 rpm**

DRIVE OF YOUR LIFE

WORLD-CLASS AUTOMATIC TRANSMISSIONS



6 Speed AISIN* Automatic Transmission

- **Best-in-class Drivability**
 - Advanced Neutral Control
- **Best-in-class NVH**
 - Super long travel damper



6 Speed AutoSHIFT+

- **300 Nm capacity**
- **Seamless gear-shifts**
- **Mono-stable shifter**

DRIVE OF YOUR LIFE

UNPARALLELED LOW-END TORQUE AND TRANSIENT RESPONSE

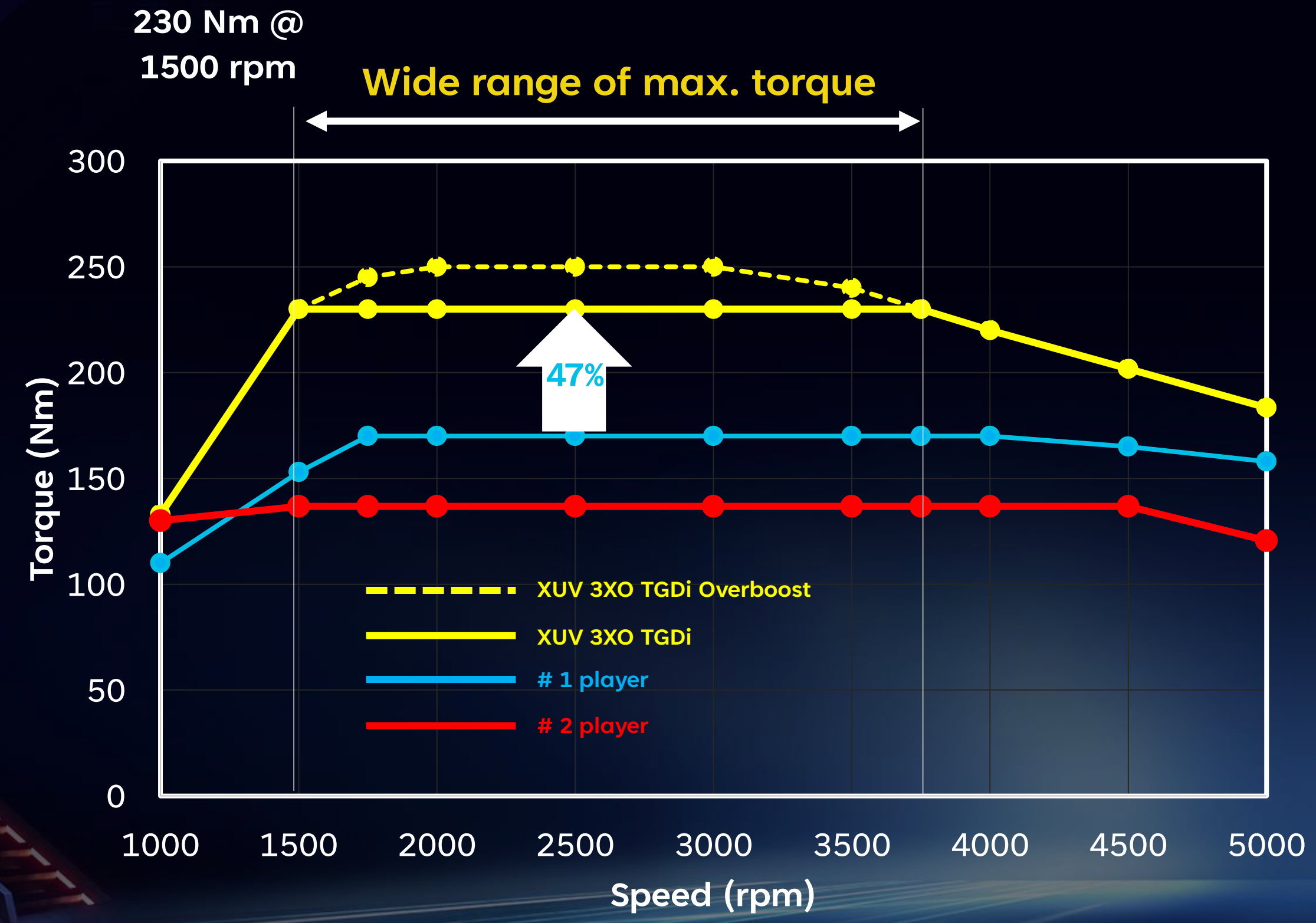

G12 TGD (AT)

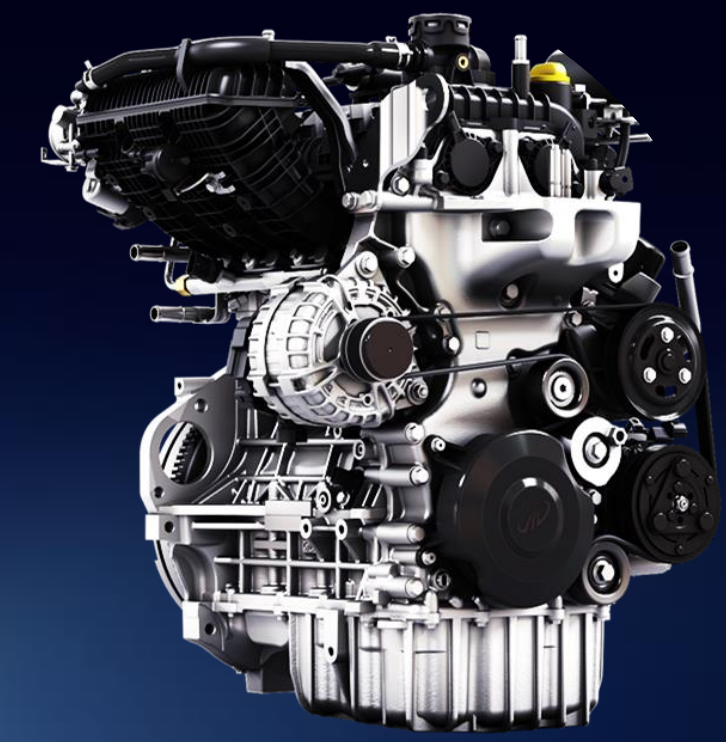

0-60 km/h
in 4.4 s

- 250 bar GDI
- Electric-VGT

6 PILLARS

STANDOUT DESIGN

SUV COMMAND SEATING

SAFE COCOON

DRIVE OF YOUR LIFE

RIDE OF YOUR LIFE

SPACE WHERE IT COUNTS

RIDE OF YOUR LIFE

ADVANCED SUSPENSION SYSTEM

Independent Front Suspension MacPherson

- Rebound stopper in top mount to reduce impact forces

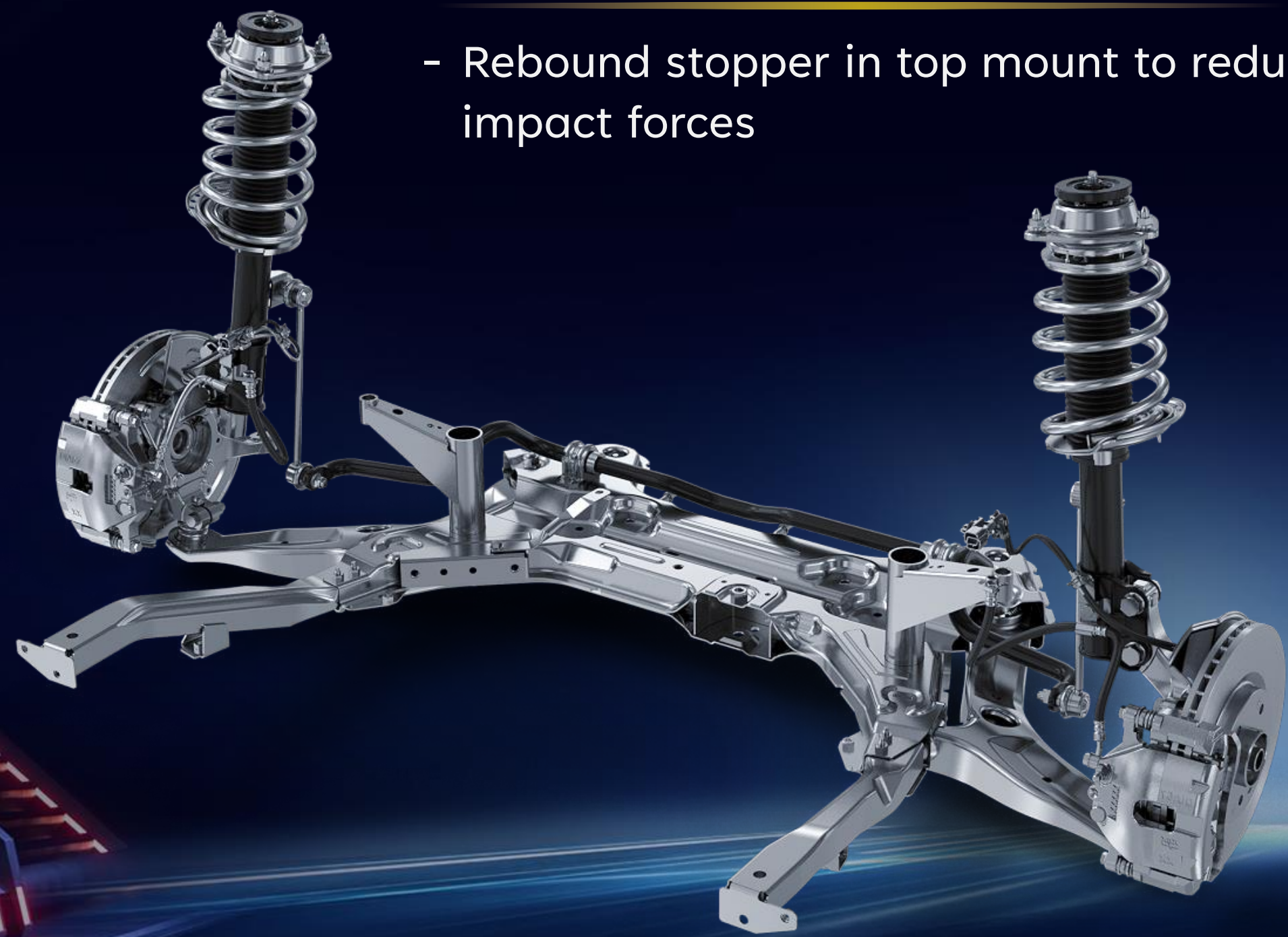

Semi-Independent Rear Suspension Twist Beam

- Improved roll stability with highest spring span in lateral direction

XUV 3XO – 1108 mm
1 Player – 980 mm
2 player – 1020 mm



RIDE OF YOUR LIFE

MTV-CL TECHNOLOGY

Piston Velocity vs Road Undulations

Vehicle speed : 60 km/h = 16.66 m/s



MTV-CL

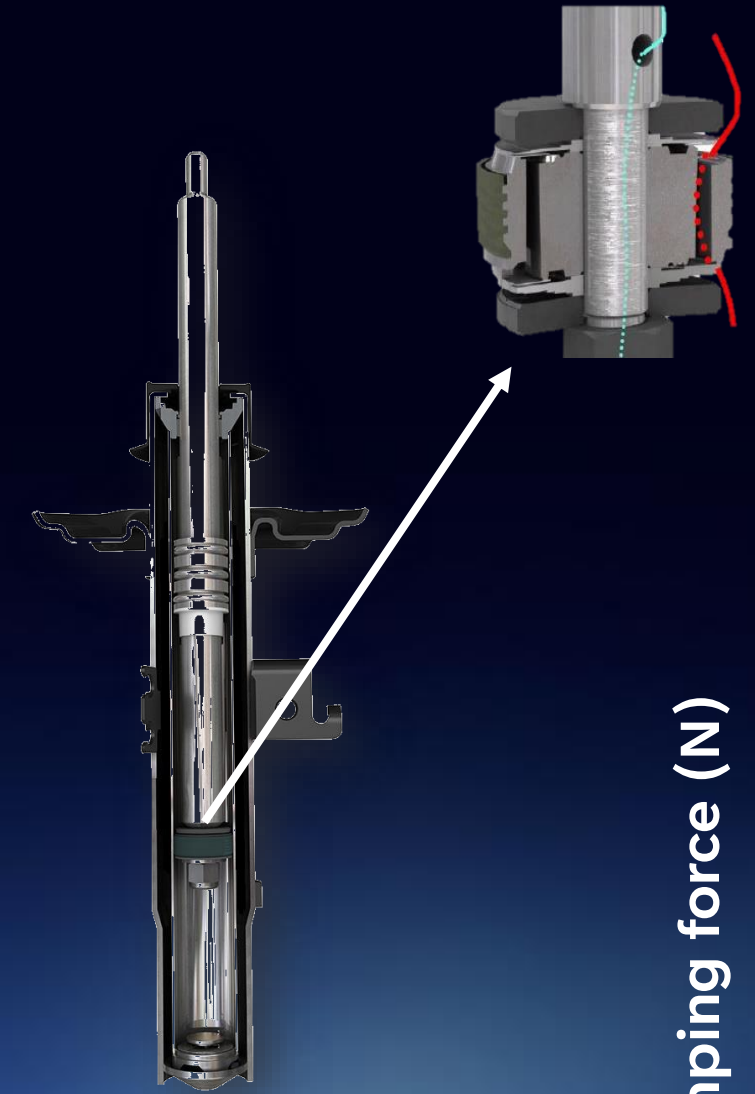

Plush Ride vs Body Control (Head toss)

- Ride comfort - Reduced damping force at high piston velocity Increased damping force at low
- Body control - Increased damping force at low piston velocity

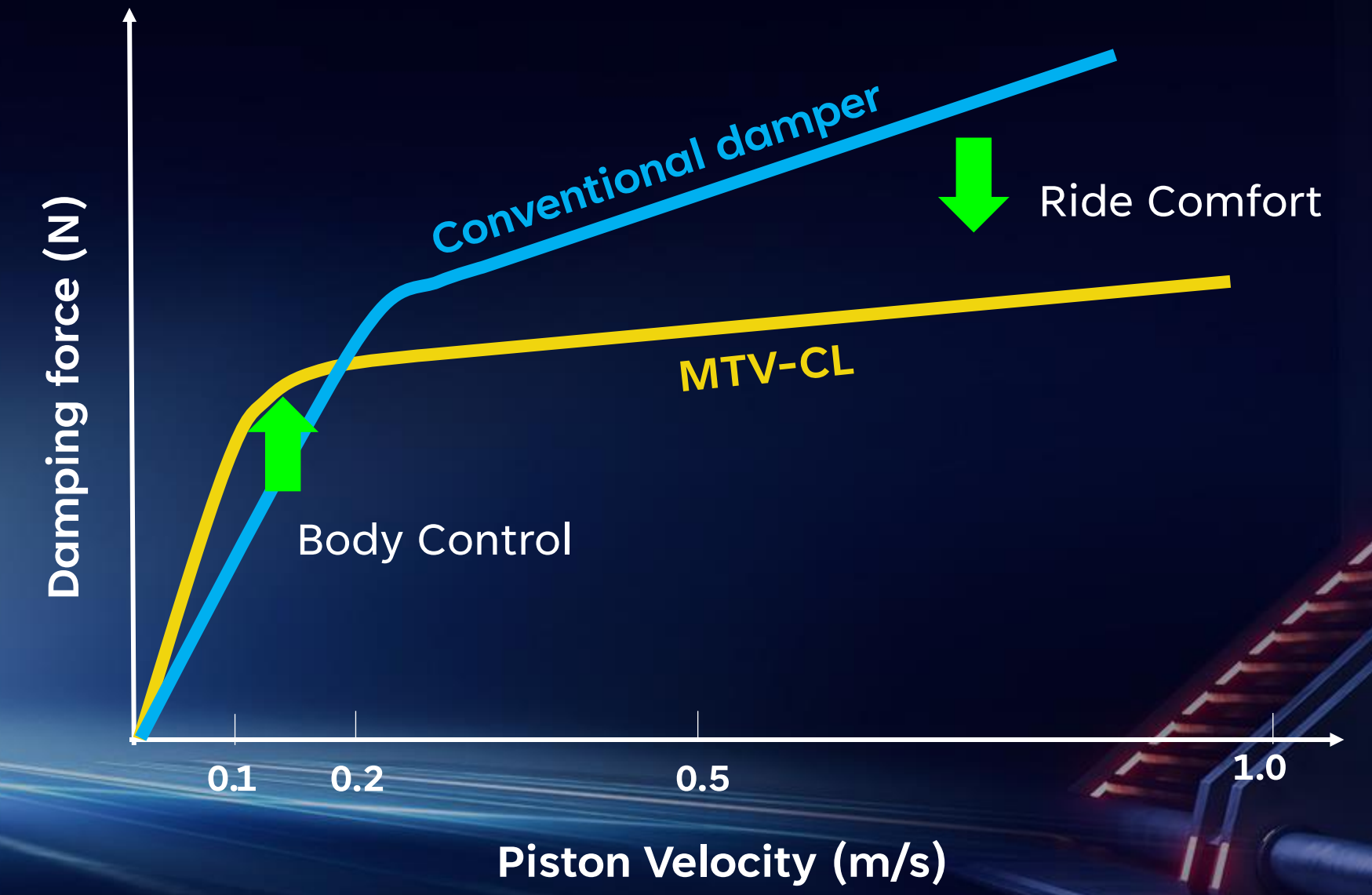

RIDE OF YOUR LIFE

QUIET & COMFORTABLE CABIN

Gear Run-up : Noise at Driver Location (TCMPFi)

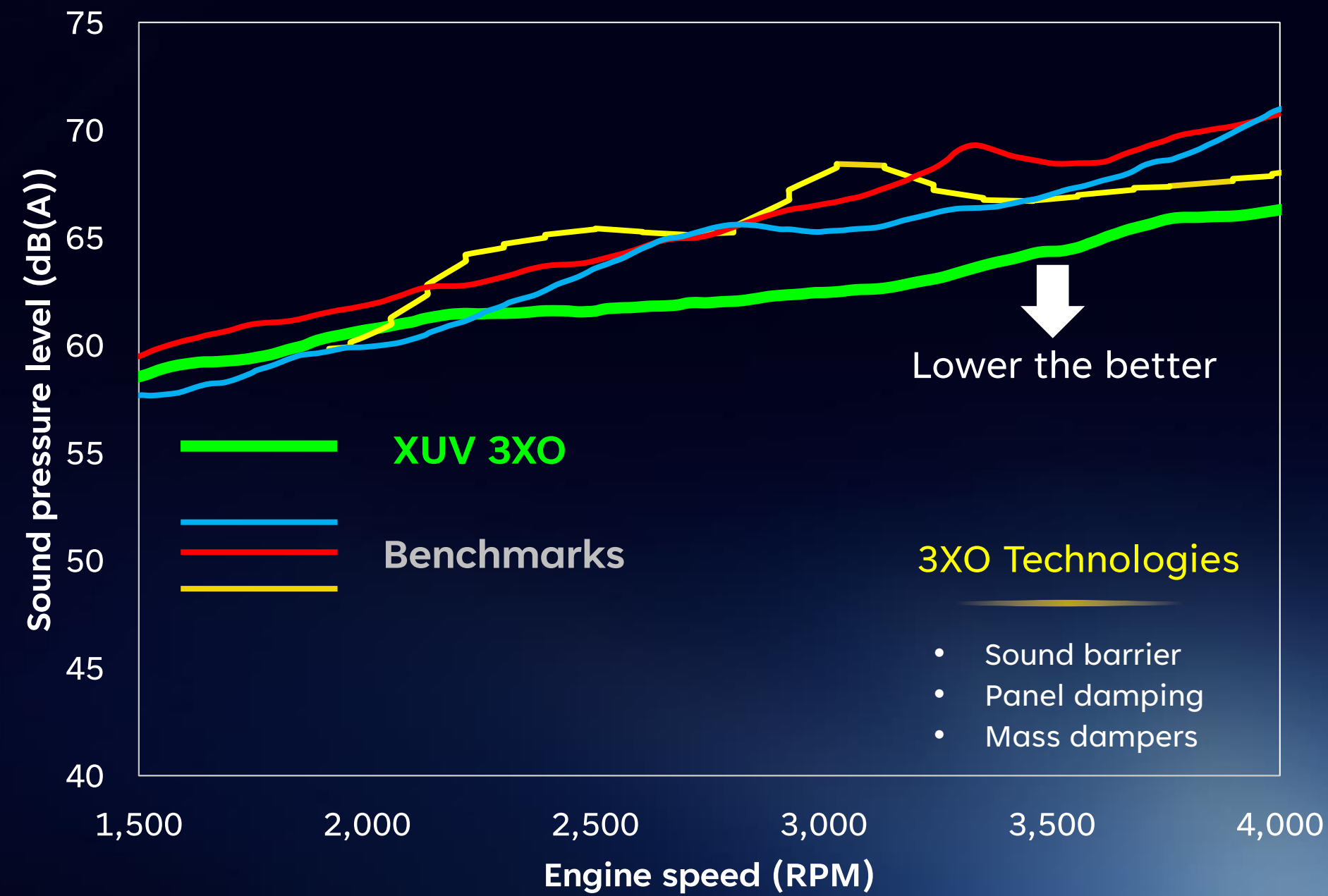

Gear Run-up : Articulation Index (Sound quality) (TCMPFi)

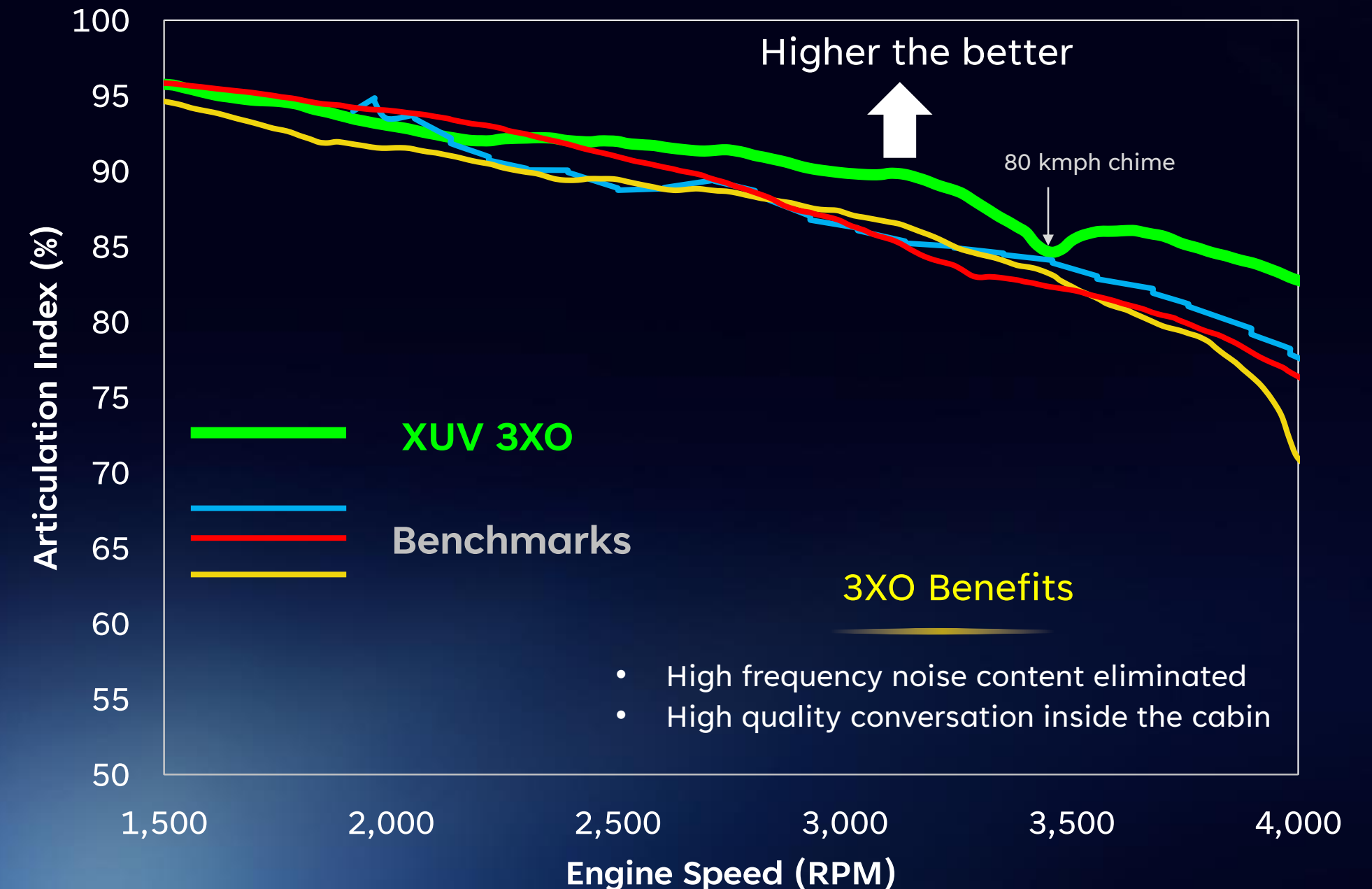

XUV 3XO gasoline quietness matches XUV 700 gasoline !

6 PILLARS

STANDOUT DESIGN

SUV COMMAND SEATING

SAFE COCOON

DRIVE OF YOUR LIFE

RIDE OF YOUR LIFE

SPACE WHERE IT COUNTS

SPACE WHERE IT COUNTS

BEST-IN-CLASS OCCUPANT SPACE

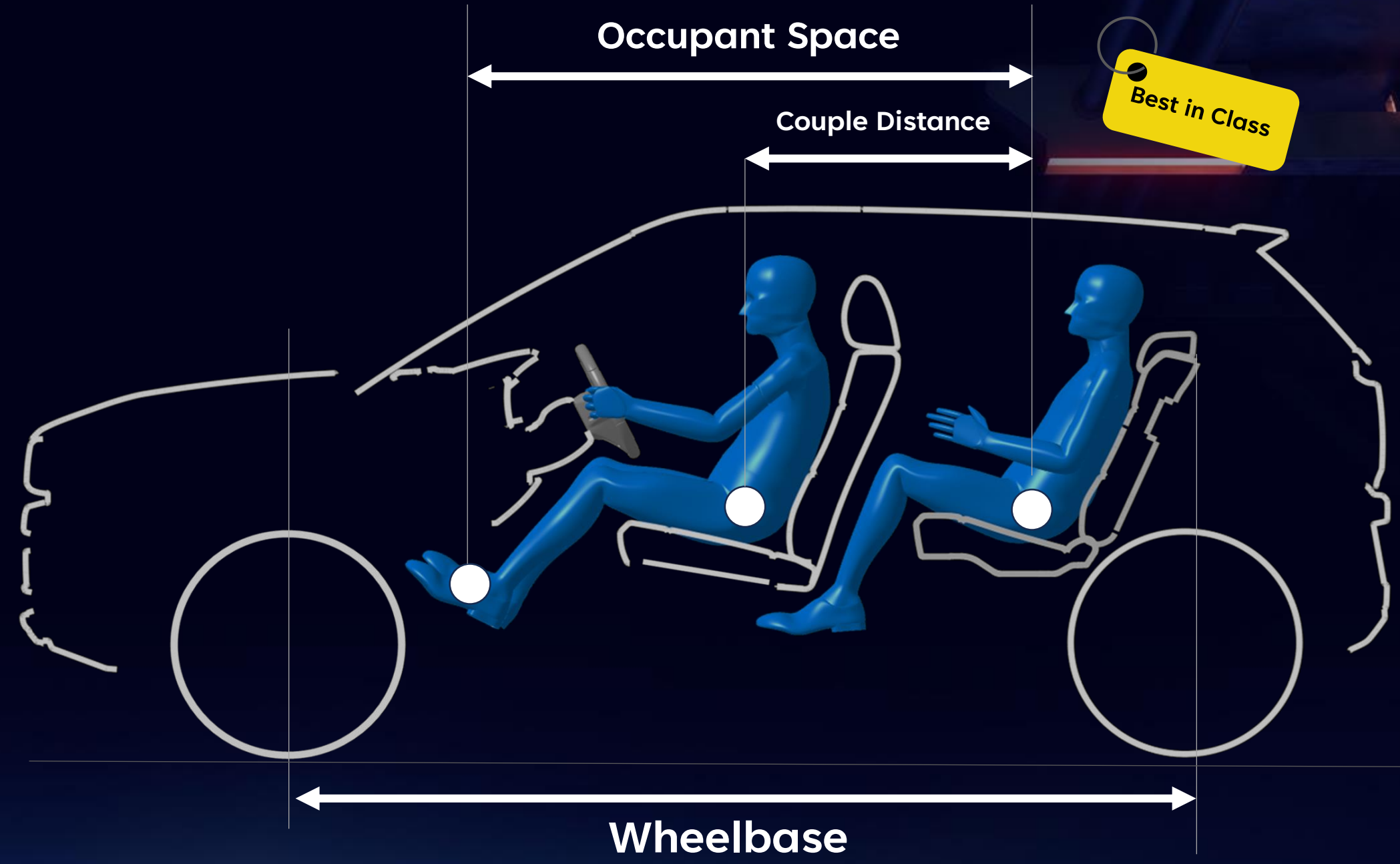

Parameter	XUV 3X0	#1 Player	#2 Player
Wheelbase (mm)	2600	2498	2500
Occupant Space (mm)	1729	1664	1671
Couple Distance (mm)	800	764	763

SPACE WHERE IT COUNTS

BEST-IN-CLASS ROOMINESS

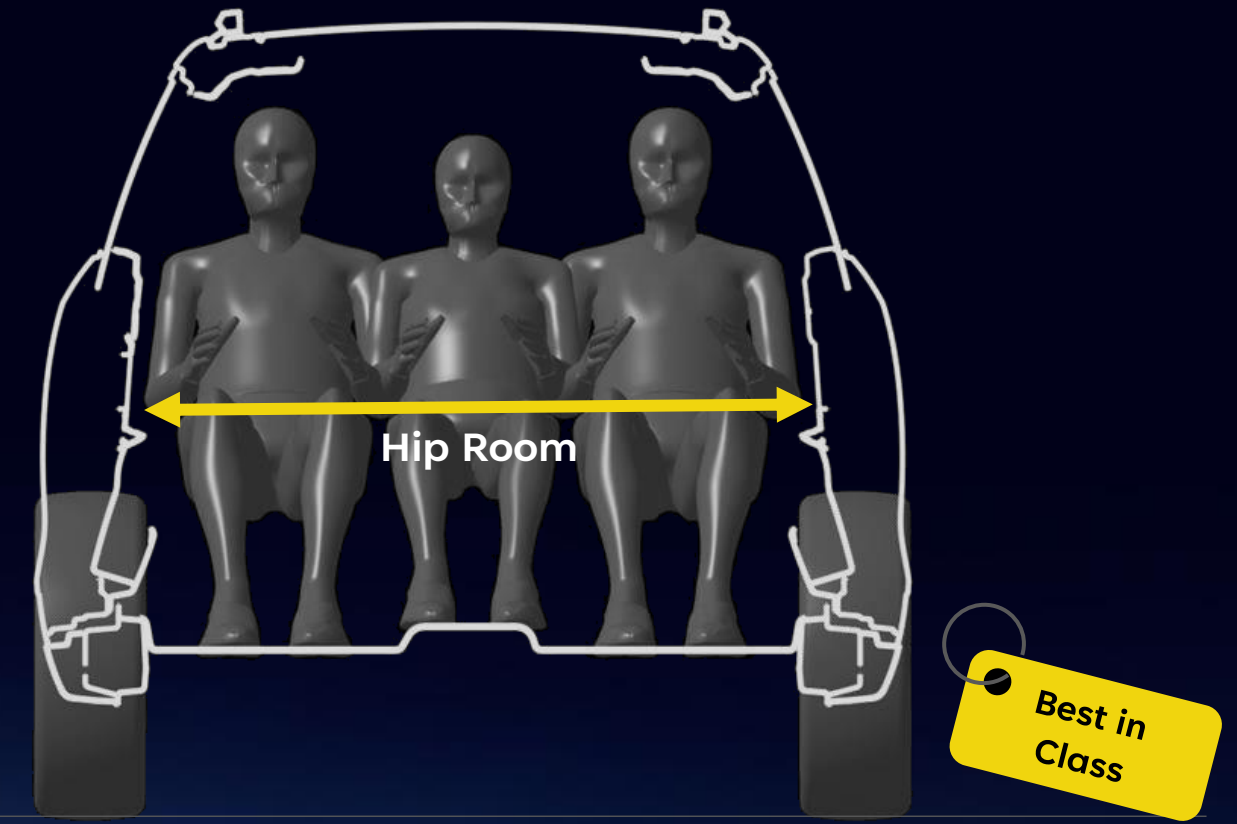
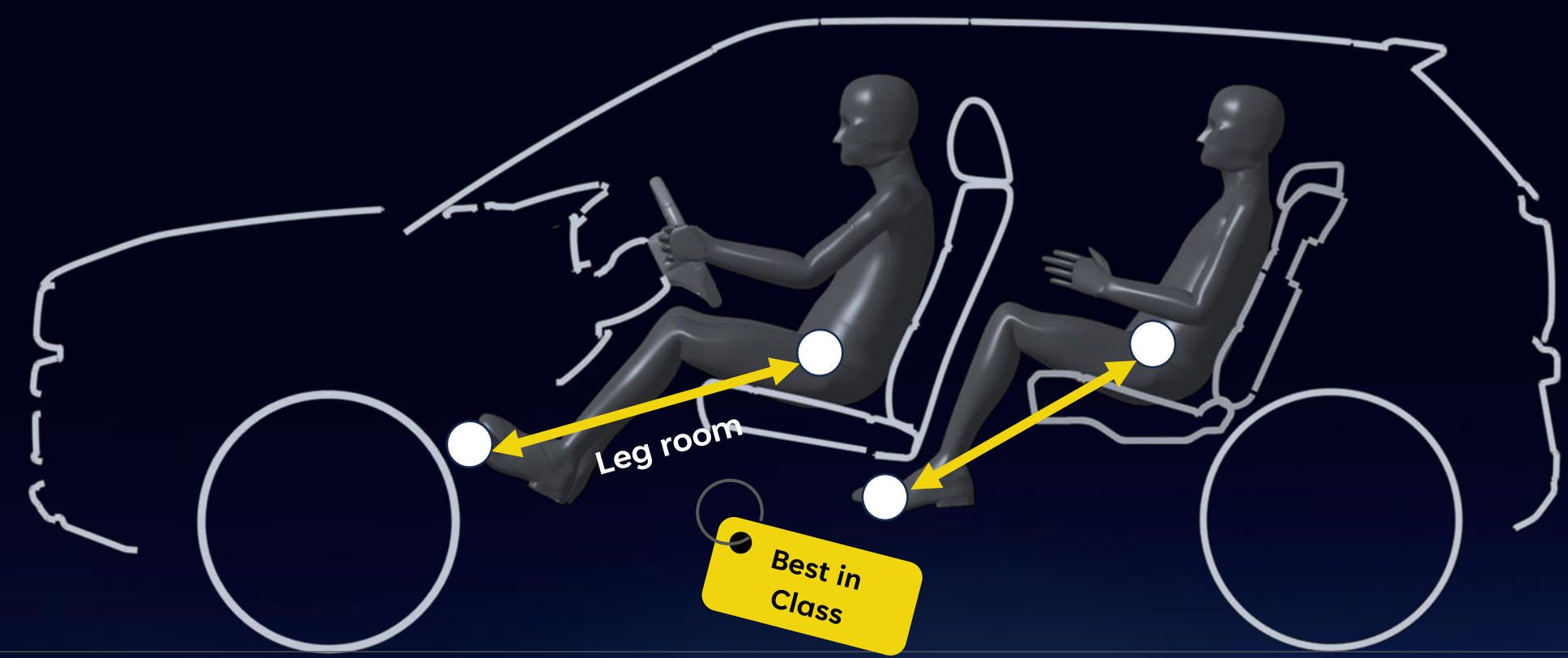

Parameter	XUV 3XO	#1 Player	#2 Player
Leg Room (1st row))	1050	1018	1036
Leg Room (2nd row)	878	826	850
Hip Room (1st row)	1337	1332	1310
Hip Room (2nd row)	1308	1222	1212

SPACE WHERE IT COUNTS

VERSATILE AND EXPANDABLE BOOT-SPACE

Parameter	XUV 3X0	#1 Player	#2 Player
Luggage volume (up to back rest) (VDA - ISO V211)	295	290	293
Luggage volume (up to roof) (ISO V215)	364	374	411
Standard 60:40 split rear seat	✓	X	X

AV

“ & MORE ”
THE DISRUPTIVE PILLAR

SCI-FI TECHNOLOGY

LEVEL-2 ADAS

First and only SUV in the segment to offer
Level 2 ADAS – 1R1V

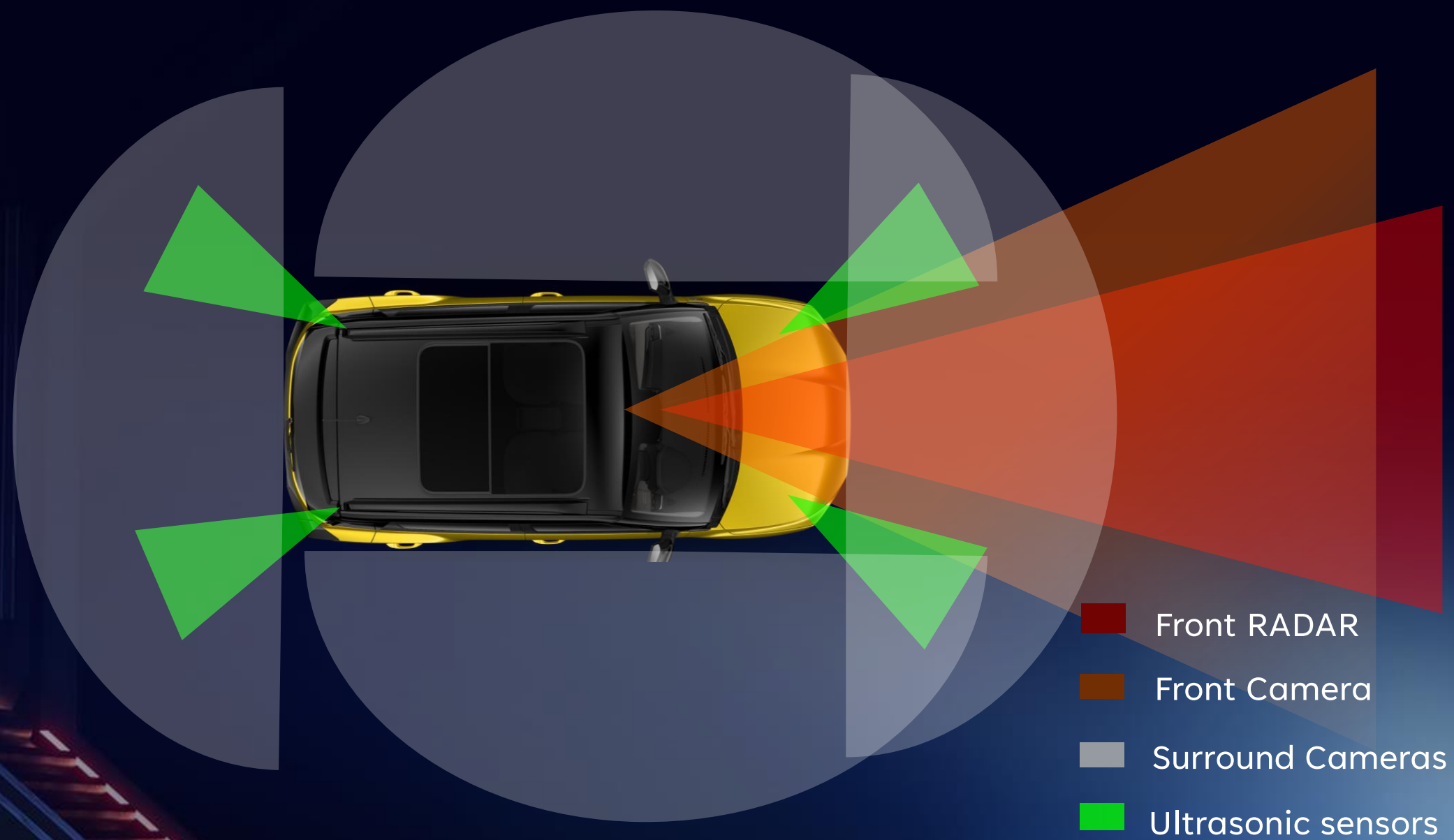

XUV 3X0 ADAS system is same as XUV 700 !

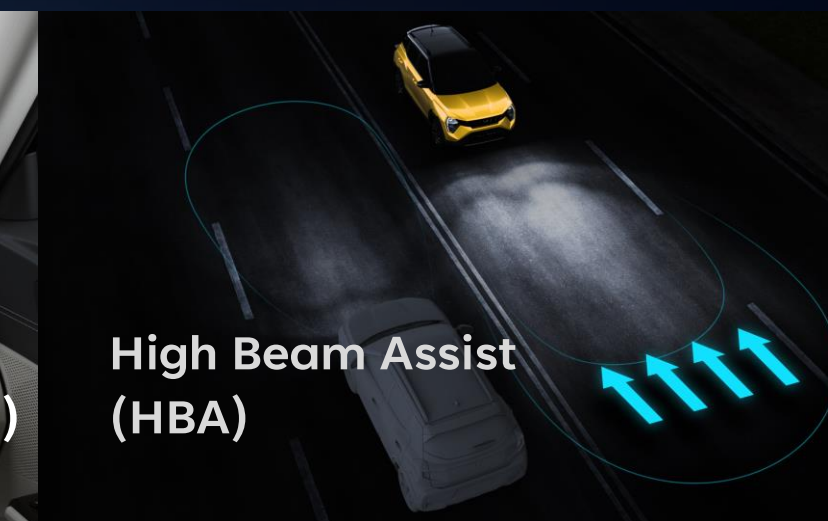
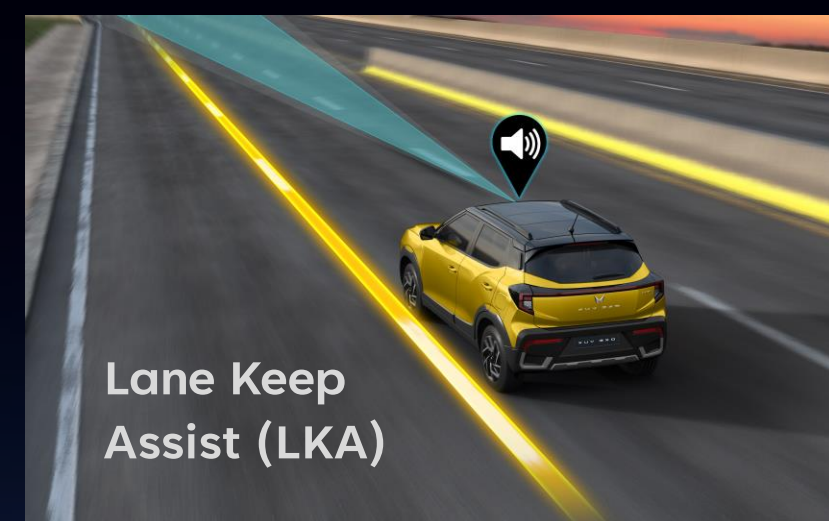
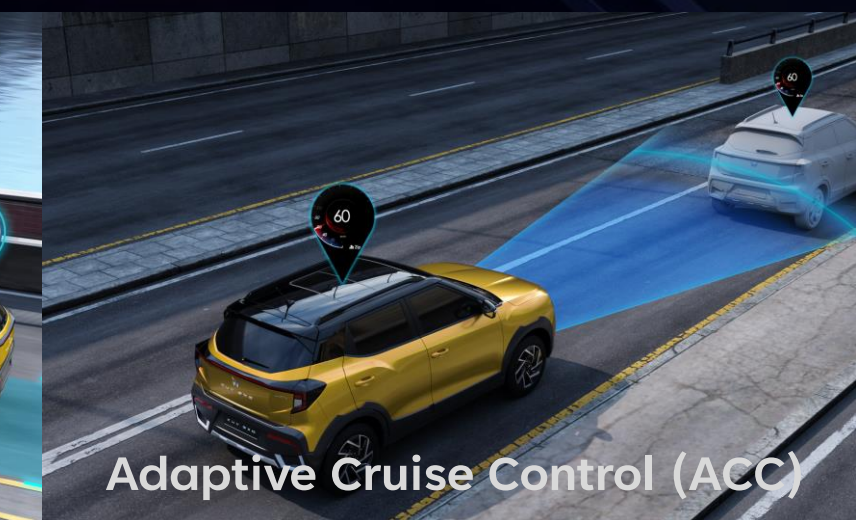
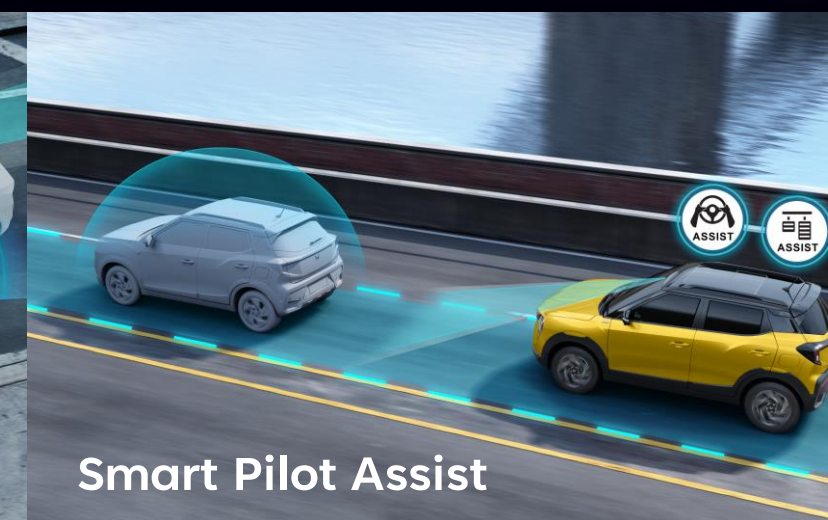

harman/kardon AUDIO

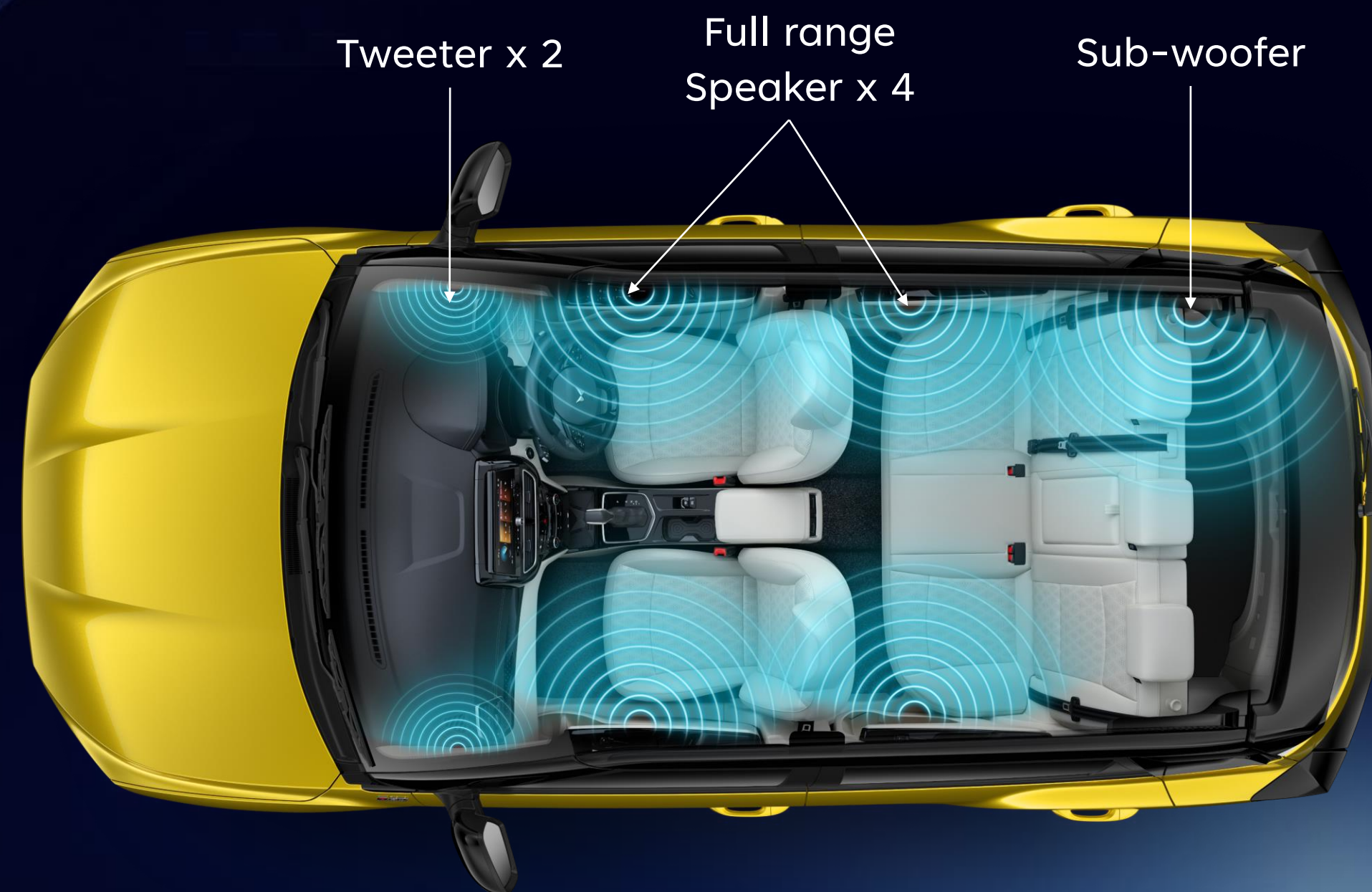

Dedicated Amplifier – 380 W *

Driving tweeters, full-range speakers and sub-woofers independently for an immersive sound experience

- 7 Speakers Surround system
- 9 Band Equalizer (as against 3 in competition)
 - Precise & Personalized sound control
- Bass Enhancer
- Powerful processor to provide multiple modes (Griffin DSP)
- 6 Modes of Audio Settings through dedicated amplifier
 - Studio
 - Sonic Expanse
 - Ambience (Stage, Party, Retreat, Wide Sonic)

360° SURROUND VIEW SYSTEM

Feature Packed Surround View System

- Blind View Monitor
- Drive Video Recording
- Static & Dynamic Guidelines
- Intuitive animations
- Interactive parking guidance
- Multiple View Options
 - 3D, Transparent, Wide, Full-screen

Multiple View Options



Blind View Monitor Parking Guidance



XUV 3X0 Surround View System is same as XUV 700 !

FIRST AND ONLY SUV IN THE SEGMENT TO OFFER
SKYROOF



ADRENOX CONNECT

Trip Summary

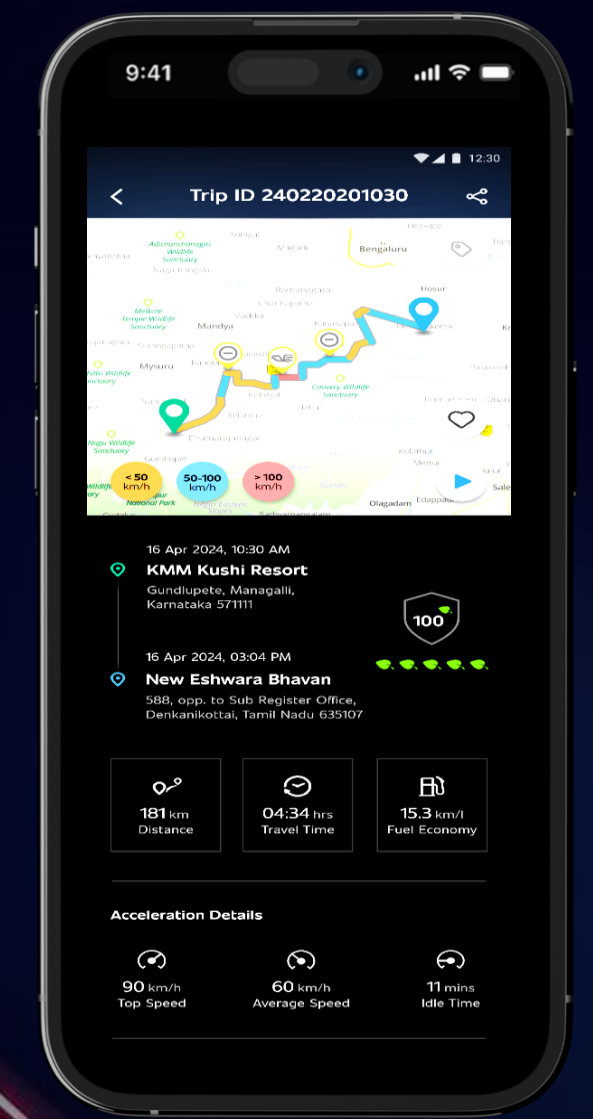

Remote Vehicle Controls



Alexa Built-in*

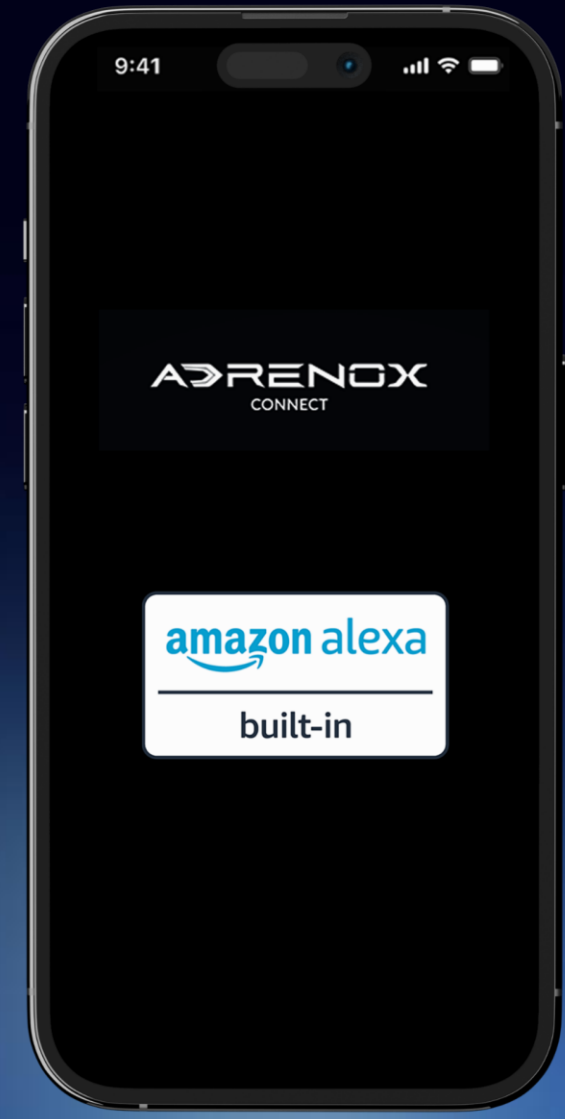

Vehicle Status Monitoring

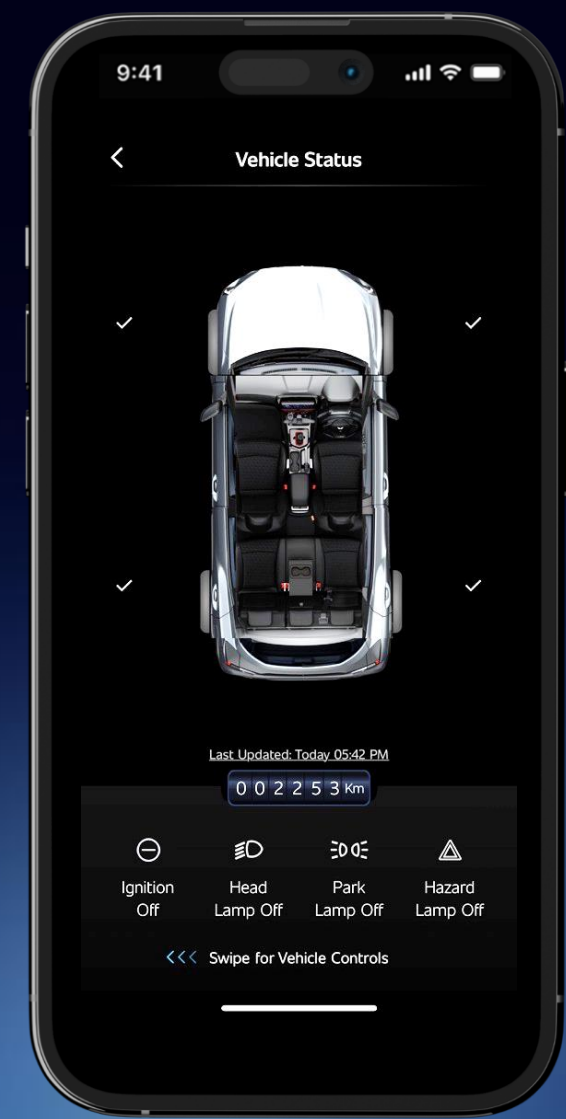

80+ FEATURES



Smart Wearables



In-home Alexa



* Feature to be updated

TECH FEATURES & IN-CAR APPS

 Wireless



androidauto



Apple CarPlay

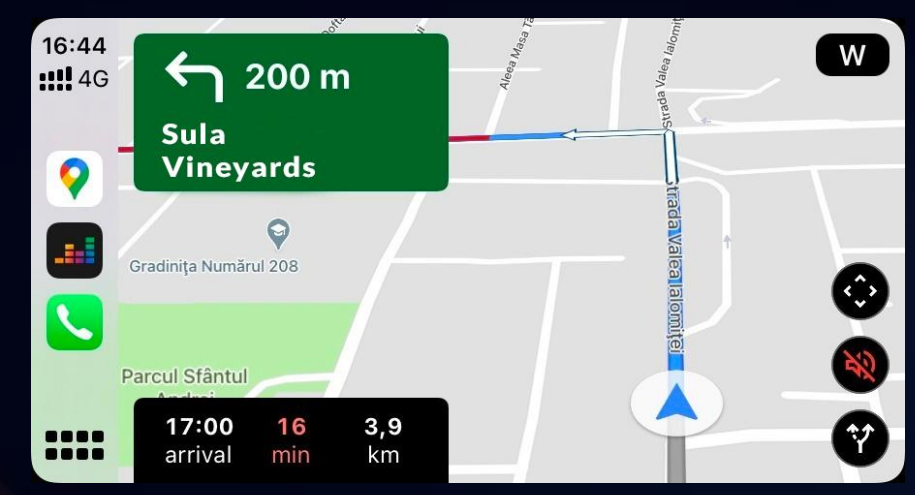

SEGMENT SHAKERS

RISE ABOVE

EXPERIENCE THE SUV SWAGGER

I want to trade up from a Hatch to an SUV,
because who doesn't want to rule the road!

In an SUV, I command, sitting tall above the rest. Now, if
only I could rock that swagger without the wallet workout!

FOR YOU WE HAVE **MX 1** WITH...

18.89 Km/l
Fuel Efficiency

Best-in-class
Occupant
Space
(1729 mm)

TCMPFi
82 kW Power
200Nm Torque

Best-in-class
forward
visibility of
23.7°

ESP Suite,
All 4-disc
brakes,
6 airbags

& More...

THE MX1 - SUV SWAGGER & MUCH MORE

XUV 3XO

	XUV 3XO	#1 Player	#2 Player
PERFORMANCE	82 kW, 200 Nm FE - 18.89 km/l Steering modes Drive Modes X	88.2 kW, 170 Nm FE - 17.33 km/l X ✓	75.8 kW, 136.8 Nm FE - 17.38 km/l X X
TECH	Micro Hybrid start stop, Rear USB-C	X	X
SAFETY	All Four Disc Brakes 6 Airbags & ESC	X ✓	X 2 Airbags & ESC
DESIGN	Projector Halogen	LED & DRLs	Halogen
COMFORT	Front Arm rest with storage, 60:40 Split rear seat Electrically Adj. ORVM, Rear AC Vent Front & Rear Power Windows	X X Front Only	X ✓ ✓
SPACE	✓	X	X
	7.49 Lakh	(8.14 Lakh)	(8.34 Lakh)

MX2 PRO ADDITIONALLY OFFERS....

Electric
Sunroof

26.03 cm
Infotainment

Remote
Keyless Entry

Steering Audio
Control

& More...

THE MX2 PRO MT - SUNROOF & MUCH MORE

XUV 3XO

	XUV 3XO	#1 Player	#2 Player
PERFORMANCE	82 kW, 200 Nm FE - 18.89 km/l Steering modes Drive Modes X	88.2 kW, 170 Nm FE - 17.33 km/l X ✓	75.8 kW, 136.8 Nm FE - 17.38 km/l X X
TECH	26.03 cm Infotainment Micro Hybrid start stop Wired AACCP, Auto Headlamps X	17.8 cm X ✓	17.8 cm X X
SAFETY	All Four Disc Brakes 6 Airbags & ESC	X ✓	X 2 Airbags & ESC
DESIGN	Projector Halogen	LED & DRLs	Halogen
COMFORT	Electric Sunroof Front Arm rest with storage, 60:40 Split rear seat Electric Fold ORVMs X	✓ X X	X X ✓
SPACE	✓	X	X
	8.99 Lakh	(10.29 Lakh)	(9.69 Lakh)

THE MX2 PRO AT - SUNROOF & MUCH MORE

XUV 3XO

	XUV- 3XO	#1 Player	#2 Player
PERFORMANCE	82 kW, 200 Nm FE - 17.96 km/l Drive Modes & Steering modes 26.03 cm Infotainment	88.2 kW, 170 Nm FE - 17.01 km/l Drive modes 17.8 cm	75.8 kW, 136.8 Nm FE - 19.80 km/l X 17.8 cm
TECH	Micro Hybrid start stop 17.8 cm Cluster, Auto Headlamps X Wired AACP, FATC X	X ✓ ✓	Mild Hybrid X ✓
SAFETY	All Four Disc Brakes 6 Airbags & ESC Reverse Camera + TPMS X	X ✓ ✓	X 2 Airbags & ESC X
DESIGN	Sequential LED Lamps, R16 Alloys, X Rear Spoiler + Roof rails	✓	X
COMFORT	Electric Sunroof, Front Arm rest with storage, 60:40 Split rear seat Cooled glovebox X Electric Fold ORVMs X	X ✓ X	X X ✓
SPACE	✓	X	X
	9.99 Lakh	(12.29 Lakh)	(11.09 Lakh)

WITH **MX3** YOU WILL ADDITIONALLY GET....

HD
Infotainment
(26.03 cm)

Wireless
Android Auto &
Wired Apple
Carplay

Cruise
Control

& More...

THE MX3 – CRUISE CONTROL, WIRELESS CHARGER & MUCH MORE

XUV 3XO

	XUV 3XO	#1 Player	#2 Player
PERFORMANCE	82 kW, 200 Nm FE - 18.89 km/l Steering modes Drive Modes X	88.2 kW, 170 Nm FE - 17.33 km/l X ✓	75.8 kW, 136.8 Nm FE - 17.38 km/l X X
TECH	26.03 cm HD Infotainment Micro Hybrid start stop, Wireless Charger, Cruise Control Auto Headlamps & Wipers X FATC X	17.8 cm X ✓ X	17.8 cm X X ✓
SAFETY	All Four Disc Brakes 6 Airbags & ESC	X ✓	X 2 Airbags & ESC
DESIGN	Projector Halogen	LED & DRLs	Halogen
COMFORT	Electric Sunroof Front Arm rest with storage, 60:40 Split rear seat Electric Fold ORVMs X	✓ X X	X X ✓
SPACE	✓	X	X
	9.49 Lakh	(10.29 Lakh)	(9.69 Lakh)

TECHNOLOGY ON STEROIDS

Adrenox? They say it's revolutionary.

As for me, I'm all about embracing the latest tech to stay in control, no matter where the road takes me.

FOR YOU WE HAVE **AX5** WITH...

Alexa Built-in*
& Online
Navigation

Dual Zone
Climate
Control

Adrenox
Connect
80+ features

Twin HD 26.03
cm Screens

Infinity LED
Tail Lamp

& More...

THE AX5 - ADRENOX AND MUCH MORE

XUV 3XO

	XUV 3XO	#1 Player	#2 Player
TECH	26.03 cm Infotainment	✓	17.8 cm
	26.03 cm Digital Cluster	17.8 cm Digital Cluster	10.7 cm Cluster
	Alexa, Connected Car, Wireless Charger, Auto headlamps + Auto wipers	X	X
	Dual Zone Climate Control	X	X
PERFORMANCE	82 kW, 200 Nm FE - 18.89 km/l	88.2 kW, 170 Nm FE - 17.33 km/l	75.8 kW, 136.8 Nm FE - 19.89 km/l
	Steering modes	X	X
	Drive Modes X	✓	X
SAFETY	All Four Disc Brakes	X	X
	360 Camera, FPAS, Auto Dim IRVM X	✓	X
DESIGN	Infinity LED Tail Lamp	✓	X
COMFORT	Electric Sunroof	✓	✓
	Leather steering & Gear Knob	X	X
	60:40 Split rear seat, Front Armrest	X	X
SPACE	✓	X	X
	10.69 Lakh	(12.29 Lakh)	(11.14 Lakh)

THRILL TO THE EDGE

Life's one big adventure, and I'm here to seize every moment. I crave the thrill of speed, the rush of the outdoors, but hey, safety first!

That's where ADAS kicks in – seamlessly blending excitement with safety on every drive, one genius move at a time!

FOR YOU WE HAVE **AX5L** WITH...

TGDi Gasoline
(AT) 96 kW,
230 Nm

Acceleration:
0-60 Km/h in
4.5s (MT)
4.4s (AT)

Drive Modes
Zip Zap Zoom

Level 2 ADAS
1R1V

360° Surround
View & EPB

& More...

AX5L AT - THRILL, ADAS & MUCH MORE

XUV 3XO

	XUV 3XO	#1 Player	#2 Player
PERFORMANCE	96 kW, 230 Nm FE - 18.2 km/l Steering modes & Drive Modes	88.2 kW, 170 Nm FE - 17.18 km/l Drive Modes	75.8 kW, 136.8 Nm FE - 19.8 km/l X
TECH	26.03 cm Infotainment, 26.03 cm Cluster	✓	22.86 cm Infotainment, 10.7 cm Cluster
	Electronic Parking Brake	X	X
	Dual Zone Climate Control	X	X
	Heads Up Display X Sound Staging by DTS	X JBL Audio	✓ Arkamys Surround Sense
SAFETY	Level 2 ADAS	X	X
	Front Parking Sensors X	✓	X
	Front Fog Lamps X	✓	✓
DESIGN	Infinity LED Tail lamp	✓	X
COMFORT	Leatherette Seats Ventilated Fr Seats X	✓	X
	Passive Keyless Entry & Push Button Start	✓	✓
SPACE	✓	X	X
	13.49 Lakh	(14.79 Lakh)	(13.98 Lakh)

AX5L MT - THRILL, ADAS & MUCH MORE

XUV 3XO

	XUV 3XO	#1 Player	#2 Player
PERFORMANCE	96 kW, 230 Nm FE - 20.1 km/l Steering modes	88.2 kW, 170 Nm FE - 17.33 km/l X	75.8 kW, 136.8 Nm FE - 19.89 km/l X
	Drive Modes X	✓	X
TECH	26.03 cm Infotainment, 26.03 cm Cluster Electronic Parking Brake	✓ X	22.86 cm Infotainment, 10.7 cm Cluster X
	Dual Zone Climate Control	X	X
	Heads Up Display X	X	✓
	Sound Staging by DTS	X	Arkamys Surround Sense
SAFETY	Level 2 ADAS	X	X
	Front Parking Sensors X	✓	X
	Front Fog Lamps X	✓	✓
DESIGN	Infinity LED Tail lamp	✓	X
COMFORT	Leatherette Seats Ventilated Fr Seats X	✓	X
	Passive Keyless Entry & Push Button Start	✓	✓
SPACE	✓	X	X
	11.99 Lakh	(13.59 Lakh)	(12.58 Lakh)

STARRY DRIVES

DRIVING WITH PANORAMIC PASSION

I'm a dreamy romantic, finding beauty in every corner of the world!
With a panoramic sunroof, I'm turning every drive into a moonlit rendezvous, no appointments required!

ROOM TO ROAM IN LUXURY

STRETCH YOUR SPACE, SHRINK YOUR SPEND!

Wish I had the roominess and luxury of a C-segment SUV to fit our fab five comfortably, but at the price tag of a compact SUV.

Luxury on a compact budget? Sign me up!

FOR YOU WE HAVE **AX7** WITH...

Harmon
Kardon
Branded Audio

R17 Diamond
Cut Alloys

Skyroof

Leatherette
dashboard,
door trims &
seats

65 W USB-C
Fast Charging

& More...

THE AX7 - SKYROOF, LUXURY & MUCH MORE

XUV 3XO

XUV 3XO

#1 C-Segment SUV Player

SPACE	W – 1821 mm WB – 2600 mm Fr & Rr Leg Room : 1050 mm / 878 mm 2nd Row Hip Room : 1308 mm Boot Space : 364L	W – 1790 mm WB – 2610 mm Fr & Rr Leg Room: 1053 mm /900 mm 2nd Row Hip Room : 1322 mm 443L
PERFORMANCE	96 kW, 230 Nm FE - 20.1 km/l Steering modes	84.4 kW, 143.8 Nm FE - 17.7 km/l X
TECH	Harman Kardon Audio 26.03 cm Infotainment, 26.03 cm Cluster Connected Car tech	X 20.32 cm Infotainment, 10.7 cm Cluster X
SAFETY	FPAS, Auto Dimming IRVM	X
DESIGN	R17 Diamond Cut Alloys	R17 Painted Alloys
COMFORT	Skyroof Leatherette dashboard & door trims Leatherette seats	✓ X X
	12.49 Lakh	(14.35 Lakh)

SIZED TO PERFECTION

Compact SUV? That's our pick!

We are all about the latest gadgets, luxurious comfort, and timeless style,
but 'big' isn't our thing.

As a dynamic duo, we're young, successful, and ready to embrace the
best of the best – without the extra bulk!

THE AX7L - SIZED TO PERFECTION

XUV 3XO

XUV 3XO

#1 C-Segment SUV Player

SPACE

W – 1821 mm | WB – 2600 mm
Fr & Rr Leg Room : 1050 mm / 878 mm
2nd Row Hip Room : 1308 mm

W – 1790mm | WB – 2610 mm
Fr & Rr Leg Room: 1053 mm /900 mm
2nd Row Hip Room : 1322 mm

Boot Space - 364L

443L

PERFORMANCE

96 kW, 230 Nm | FE - 20.1 km/l
Steering modes

84.4 kW, 143.8 Nm | FE - 17.7 km/l
X

TECH

Harman Kardon Audio
26.03 cm Infotainment, 26.03 cm Cluster
Connected Car tech, Electronic Parking Brake

Bose Audio System

SAFETY

Level 2 ADAS, 360 Camera, FPAS, Auto Dimming IRVM

✓

DESIGN

R17 Diamond Cut Alloys

✓

COMFORT

Skyroof | Leatherette seats
Leatherette dashboard & door trims
Front Ventilated Seats & Power Driver Seat X

✓

X

✓

13.99 Lakh

(17.27 Lakh)

3X0

EVERYTHING YOU WANT

&

MORE



PRESS RELEASE

Mahindra launches the XUV 3XO – the ‘New Disruptor’ in compact SUVs Prices start at ₹ 7.49 Lakh

Disrupting the category: The XUV 3XO disrupts with 6+1 key pillars:

- **Turn on Design:**
 - Bold, athletic silhouette that commands attention
 - Ivory colour interiors wrapped with a Soft touch leatherette dashboard and door trims
- **SUV Command Seating:**
 - Best-in-class forward visibility of 23.7° that matches with XUV 700
 - Command seating position with eye level at 1398 mm above the ground
 - R17 Alloy Wheels and water wading depth of 350 mm
- **Safe Cocoon:**
 - 35 standard safety features including 6 airbags, ESC with Hill Hold Control (HHC) & All 4 Disc Brakes and more
 - Engineered to meet the highest B-NCAP safety rating
- **Drive of Your Life:**
 - World-class turbocharged engines with best-in-class Torque of 230 Nm (1.2 L TDGi) and 300 Nm (1.5 L Diesel)
 - **6-speed AISIN 3rd Gen Automatic Transmission**
 - Thrilling acceleration of 0 to 60 km/h in 4.5 s (1.2 L TGD_i) and best-in-class mileage of 20.1 km/l* (1.2 L TGD_i MT)
- **Ride of Your Life:**
 - First-in-segment MTV-CL (Multi-Tuned Valve Concentric Land) technology
 - Advanced suspension system with MacPherson Strut Fully Independent Front Suspension and a Twist Beam Semi-independent Rear Suspension
 - Quietness of gasoline matching XUV 700 gasoline
- **Space where it counts:**
 - Best-in-class wheelbase, occupant space, and legroom
 - Spacious cargo area measuring 364 L**, further expanded with standard 60:40 split seats to maximize storage capacity.
- **Sci-Fi Technology**
 - **First-in-segment:** Skyroof™, Dual Zone Climate Control, 65 W USB-C charging, Electronic Parking brake with Auto Hold, 3 Smart Steering Modes, Level 2 ADAS (1R1V)
 - **3XO is also equipped with** Twin HD Screens – one 26.03 cm infotainment and the other 26.03 cm full digital cluster, Harman Kardon Premium Audio with amplifier & Sub-woofer, 360-degree surround view system with blind view monitor

Mumbai, April 29, 2024: Mahindra & Mahindra Ltd., India's leading SUV manufacturer, today launched the XUV 3XO, with prices starting from ₹ 7.49 Lakh. Setting new benchmarks in the compact SUV segment, the XUV 3XO combines standout design, premium interiors, comfortable ride, cutting-edge technology, thrilling performance, and unmatched safety. The XUV 3XO represents Mahindra's commitment to innovation and excellence, culminating in an SUV that truly represents #EverythingYouWantAndMore.

*As per ARAI Certification

**Luggage volume upto roof (ISO V215)



The XUV 3XO was conceptualised at the Mahindra India Design Studio (MIDS) in Mumbai, and engineered and developed at the Mahindra Research Valley (MRV) near Chennai. The XUV 3XO represents the world-class capabilities of Mahindra's global design and engineering team. Built at Mahindra's state-of-the-art facility in Nashik using advanced manufacturing processes, it offers customers a high-quality SUV that is robust and engineered to last.

Appealing to multiple segments XUV 3XO transcends the expectations of the new-age SUV buyers. Each variant is tailored to meet the specific needs and preferences of its respective segment, making the XUV 3XO a true category disruptor.

Mr. Veejay Nakra, President – Automotive Division, Mahindra & Mahindra Ltd. said, *"With the launch of the XUV 3XO, starting at an attractive price of ₹ 7.49 Lakh, Mahindra is redefining what an SUV can be. Engineered to deliver 'Everything you want & more,' the XUV 3XO is designed to cater to a broad spectrum of customers. From those upgrading from a hatchback to their first SUV to luxury seekers looking for high-end features at a competitive price, the XUV 3XO offers a unique blend of innovation, safety, comfort, and performance. Each variant is a strategic response to the nuanced needs of different customer segments, effectively making each variant a disruptor in its segment."*

R Velusamy, President, Automotive Technology and Product Development, Mahindra & Mahindra Ltd. said, *"The XUV 3XO exemplifies Mahindra's dedication to blending top-tier safety, cutting-edge technology and thrilling performance with standout design. Built on a durable, well-tested platform, it is engineered to meet the highest global safety standards, including the B-NCAP. The XUV 3XO also meets the benchmarks established by our XUV700 – offering best-in-class forward visibility and the quietness of its gasoline variant is comparable to that of the gasoline. With superior drivetrain options, robust Level 2 ADAS features, a comprehensive suite of safety equipment, and advanced technological enhancements, the XUV 3XO is crafted to deliver a driving experience that's exhilarating, secure, and ahead of its class."*

The XUV 3XO has been designed, developed, and engineered to meet rigorous global standards, ensuring that it delivers exceptional quality and performance to our customers. Mahindra will be introducing the XUV 3XO in global markets, details will be announced shortly.

The XUV 3XO's bookings will open online and simultaneously at Mahindra dealerships from May 15, 2024. The deliveries of the XUV 3XO will commence starting from May 26, 2024, ensuring that customers can enjoy their new Mahindra SUV as soon as possible.



More about the XUV 3XO

Standout Design

The XUV 3XO introduces a bold, **athletic silhouette** that commands attention. It features a distinctive front fascia with a **piano black finish** on the grille and LED Headlamps, LED DRLs and LED Fog Lamps. At the rear, the infinity LED tail lamp emphasises the wide and stable stance of the XUV 3XO.

XUV 3XO's interiors complement its striking exterior with a **blend of premiumness and modernity**. Its cabin, boasts premium **Ivory colour interiors** with a Soft touch **leatherette dashboard that extends to the door trims**, and **leatherette seat upholstery** to elevate the sense of sophistication. Leather accents on the steering wheel, gear knob, and front armrest further enhance the premium feel.

SUV Command Seating

The SUV's credentials are further enhanced by its longest-in-class bonnet, adding a sense of robustness and forward motion. With a command seating position, eye level at 1398 mm above the ground, the XUV 3XO offers **best-in-class forward visibility of 23.7°**, similar to the XUV 700. **Bold wheel arches and large tyres** underscore its ruggedness, with the **largest tyre outside diameter (OD)** in its class, contributing to a formidable stance. The impressive ground clearance, calibrated approach and departure angles, and best-in-class **water wading depth** amplify the XUV 3XO's SUVness factor. Complementing these features are the segment-leading R17 Diamond Cut Alloy Wheels, which further accentuate its authoritative presence.

Eye Point to Ground (mm)	Forward Visibility	Bonnet Length (mm)	Ground Clearance (mm)	Approach Angle	Departure Angle	Water Wading Depth (mm)
1398	23.7°	1033	201	23.4°	39.6°	350

Safe Cocoon

Safety is paramount in the XUV 3XO, ensured by the extensive use of high-strength steel and 35 standard safety features. Engineered to achieve the highest **B-NCAP safety rating**, the XUV 3XO sets new standards in vehicle safety, ensuring peace of mind for you and your loved ones on every journey.

Additional cutting-edge safety technologies include a **360-degree surround view system with Blind View Monitor**, **new-generation Electronic Stability Control (ESC)** with **hill hold control** and **hill descent control**, ensuring superior control in challenging driving conditions. Furthermore, the vehicle comes standard with **6 airbags**, **4 disc brakes**, **3-point seat belts** and **seat-belt reminder for all seats along with passenger airbag on/off for child safety**, **ISO-FIX child seats with top-tether**, among others, providing comprehensive protection for all occupants.

These features underscore the XUV 3XO's commitment to safety, establishing it as a leader in its class for both active and passive safety systems.



Drive of Your Life

The XUV 3XO is powered by a lineup of world-class Turbo engines designed for exhilarating performance and superior efficiency. Staying true to the brand’s legacy of offering thrilling performance, both the mStallion TGD*i* and the Turbo Diesel engines churn out best-in-class power and torque of 96 kW (130 PS) & 230 Nm and 85.8 kW (117 PS) & 300 Nm respectively. Additionally, the mStallion TGD*i* clocks 0-60 km/h in 4.5 s while offering a segment best fuel efficiency of 20.1 km/l* with manual transmission.

The XUV 3XO is equipped with **6-speed AISIN 3rd Gen Automatic Transmission**, renowned for its durability and reliability, as evidenced by its successful implementation in the XUV 700, which utilises a transmission from the same family. The transmission offers smooth gear shifts and is optimised to deliver great fuel efficiency as well as a ‘fun to drive’ experience.

Each engine is available with a 6-speed manual gear box and an added option of 6-speed AISIN automatic transmission for the petrol engines and 6-Speed AutoSHIFT+ for the diesel variants.

Engine Type	Max Power	Max. Torque	Transmission	Fuel Efficiency*
1.2 L mStallion – TGD <i>i</i> engine	96 kW @ 5000 r/min	230 Nm @ 1500-3750 r/min	MT	20.1 km/l
			6-AT	18.2 km/l
1.2 L mStallion TCMPFi engine	82 kW @ 5000 r/min	200 Nm @ 1500-3500 r/min	MT	18.89 km/l
			6 – AT	17.96 km/l
1.5 L Turbo Diesel with CRDe	85.8 kW @ 3750 r/min	300 Nm @ 1500-2500 r/min	MT	20.6 km/l
			6 – AutoSHIFT+	21.2 km/l

*As per ARAI certification

Ride of Your Life

The XUV 3XO is equipped with an advanced suspension system that includes a **MacPherson Strut Fully Independent Front Suspension** and a **Twist Beam Semi-independent Rear Suspension**. This setup ensures a ride quality that is quiet and comfortable, with quietness matching XUV 700. Additionally, the XUV 3XO features **first-in-segment three smart steering modes—Comfort, Normal, and Sport**. These smart steering modes are available across all powertrains, ensuring that every driver can enjoy a controlled and responsive driving experience, setting a new standard for what drivers can expect from a compact SUV.

The SUV also features custom drive modes—**Zip, Zap, and Zoom**—specifically in the **Petrol Automatic** variants, each designed to enhance the driving dynamics on varying terrains by adjusting the vehicle's performance characteristics. Moreover, the XUV 3XO incorporates **MTV-CL (Multi-Tuned Valve Concentric Land) technology** within the dampers. This advanced valving technology significantly improves ride and handling performance by optimizing the suspension response to different driving conditions.



Space Where it Counts

The XUV 3XO excels in providing a spacious and comfortable environment for all its occupants. It boasts **best-in-class occupant space**, which is remarkably generous, comparable even to SUVs a class above. This is complemented by the spacious boot space, which can accommodate up to 364 litre*. Additionally, the XUV 3XO offers **best-in-class leg and hip room for 1st and 2nd row passengers**, ensuring a comfortable ride for all.

Features like a **cooled glove box** with illumination and a standard 60:40 split in the rear seats ensure convenience and functionality. The front armrest which is standard from the base variant, and integrated with storage, adds to the **ergonomic and practical design**, making every journey in the XUV 3XO a blend of comfort and class.

Overall Length	Overall Width	Overall Height	Wheelbase	Occupant Space	Couple Distance	Leg Room 1 st row	Leg Room 2 nd row	Hip room 1 st row	Hip room 2 nd row
3990	1821	1647 (with roof rails)	2600	1729	800	1050	878	1337	1308

*All measurements in mm

Sci-Fi Technology

The XUV 3XO is at the forefront of automotive technology with 80+ **Adrenox features**, **twin 26.03 cm HD screens**, **wireless Android Auto & Apple Carplay**, and **built-in Alexa****. The first-in-segment features like a **65 W USB-C charging point** and **Electronic Parking Brake with Auto Hold** are tailored for tech-savvy users seeking convenience on the go. Adding to the list, an immersive audio experience is created through a **Harman Kardon Premium Audio with Amplifier & Sub-woofer** that also offers Sonic Expanse, Bass Enhancer, 9 Band Equalizer, and 4 Ambient Sound Modes.

Additionally, first-in-segment Level 2 ADAS (1R1V) with 10 features ensures enhanced driving assistance and safety measures. The inclusion of radar technology aids the ability to detect obstacles in challenging weather conditions such as heavy rain or dense fog, thereby offering crucial collision warnings and facilitating Automatic Emergency Braking (AEB).

These cutting-edge features are complemented by the **largest-in-class Skyroof™**, which not only enhances the vehicle's visual appeal but also enriches the driving experience. The 360-degree surround view system with blind view monitor further adds to the comfort and convenience of the driver.

*Luggage volume upto roof (ISO V215)

**Features to be updated at a later stage – Android Auto & Apple Car Play and built-in Alexa

Annexure - 1

Variant Walk MX Series:

MX1	MX2	MX3	
1.2 TCMPFi MT	1.5 D MT	1.2 TCMPFi MT, AT 1.5 D MT, AutoSHIFT+	
<ul style="list-style-type: none"> • Bi-Halogen projector headlamps • LED Signature lamp with front turn Indicator • LED indicator on ORVM • LED Tail lamp • 6 Airbags • Electronic Stability Control (ESC) • ISOFIX • R16 Steel Wheels • Electrically adjustable ORVM • Engine Start/Stop • Smart steering system • Power window - Front & Rear • Power window: 1-Touch Down (Driver) • Front armrest with storage • 60:40 split rear seat • Rear AC vents • Front USB-A Port and Rear USB- C • 12V socket • Adjustable headrest for 2nd row • Electronic trumpet horn • Reverse parking sensors • Seat belt reminder for all passengers • Front height adjustable seat belt • 3-points seat belt for all passengers 	<p><i>In addition to features of MX1</i></p> <ul style="list-style-type: none"> • 26.03 cm (10.25") Infotainment • 4 Speakers • Steering Audio Control • Remote Keyless Entry • Follow me home headlamp 	<p><i>In addition to features of MX2</i></p> <ul style="list-style-type: none"> • Single Pane sunroof • 26.03 cm (10.25 ") HD Infotainment • Wireless Android Auto & Wired Apple Car Play* • Cruise control • Wireless charger • Wheel Cover 	
		MX2 Pro	MX3 Pro
		1.2 TCMPFi MT, AT 1.5 D MT	1.2 TCMPFi MT, AT 1.5 D MT
	<p><i>In addition to features of MX2</i></p> <ul style="list-style-type: none"> • Single Pane sunroof • Wheel cover 	<p><i>In addition to features of MX3</i></p> <ul style="list-style-type: none"> • Bi-LED Projector headlamps • LED DRL with front turn indicator • Infinity LED tail lamp • Stylized Vector wheel 	

Variant Walk AX Series:

AX5	AX7
1.2 TCMPFi MT, AT 1.5 D MT, AutoSHIFT+	1.2 TGDİ MT, AT 1.5 D MT, AutoSHIFT+
<p><i>In addition to features of MX3 pro</i></p> <ul style="list-style-type: none"> • Twin HD 26.03 cm Infotainment & 26.03 cm Digital Cluster screen • Adrenox Connect with built-in Alexa* • Online navigation • Wireless Android Auto & Apple Car Play* • R16 Diamond Cut Alloys • Dual Zone climate control • Rear view camera • Passive Keyless Entry • Push button start • Leather steering & gear knob • Tyre pressure monitoring system • Electrically foldable ORVM • Height Adjustable driver seat • Rear armrest with cup holder • Auto headlamps + Auto wiper • Rear wiper & wash • Roof rails & Rear spoiler • Rear defogger • 6 Speakers • Adjustable head rest for 2nd row middle passenger • Power window: 1-Touch Up (Driver) 	<p><i>In addition to features of AX5</i></p> <ul style="list-style-type: none"> • Skyroof™ • Harman Kardon Premium Audio with Amplifier & Sub-woofer • Soft touch Leatherette on dashboard & door trims • Leatherette seats • R17 Diamond Cut Alloys • Auto dimming IRVM • LED front fog lamps • Front parking assist system • Cooled glove box with Illumination • 65W USB-C fast charging
AX5 L	AX7 L
1.2 TGDİ MT, AT	1.2 TGDİ MT, AT 1.5 D MT
<p><i>In addition to features of AX5</i></p> <ul style="list-style-type: none"> • Level 2 ADAS • 360-degree surround view system with Blind view monitor • Auto Dimming IRVM • Electronic parking brake with Auto Hold • Cooled Glove box 	<p><i>In addition to features of AX7</i></p> <ul style="list-style-type: none"> • Level 2 ADAS • 360-degree surround view system with Blind view monitor • Electronic parking brake with Auto Hold

*Features to be updated at a later stage – Android Auto & Apple Car Play and built-in Alexa

Annexure - 2

Variant-wise Pricing: (Ex-Showroom)

The XUV 3XO is available in 5 different trims and offers an optional Pro pack in MX2 and MX3 and luxury pack in AX5 and AX7. It also comes in 8 exciting colours for the MX series, AX5 and AX5 L, while the AX7 and AX7 L variants are offered exclusively with dual tone options, providing ample choices for personalization.

Fuel Type	DIESEL	GASOLINE			
Engine	1.5 L Turbo Diesel with CRDe	1.2 L TCMPFi engine		1.2 L mStallion - TGD i engine	
Transmission	MT	MT	AT	MT	AT
MX1	-	₹ 7.49 L	-	-	-
MX2	₹ 9.99 L	-	-	-	-
MX2 Pro	₹ 10.39 L	₹ 8.99 L	₹ 9.99 L	-	-
MX3	₹ 10.89 L*	₹ 9.49 L**	-	-	-
MX3 Pro	₹ 11.39 L	₹ 9.99 L**	-	-	-
AX5	₹ 12.09 L*	₹ 10.69 L**	-	-	-
AX5 L	-	-	-	₹ 11.99 L	₹ 13.49 L
AX7	₹ 13.69 L*	-	-	₹ 12.49 L***	-
AX7 L	₹ 14.99 L	-	-	₹ 13.99 L	₹ 15.49 L

* Variant also available in Diesel AutoSHIFT+ at an additional cost of ₹ 0.80 L

** Variant also available in TCMPFi AT at an additional cost of ₹ 1.50 L

***Variant also available in TGD i AT at an additional cost of ₹ 1.50 L



Social Media Addresses for Mahindra XUV 3XO:

- Brand website: <https://auto.mahindra.com/suv/XUV3XO>
- Twitter: @MahindraXUV3XO
- YouTube: @Mahindra_XUV3XO
- Instagram: @mahindraxuv3xo
- Facebook: @XUV3XO
- Hashtags: #MahindraXUV3XO #XUV3XO

About Mahindra

Founded in 1945, the Mahindra Group is one of the largest and most admired multinational federation of companies with 260000 employees in over 100 countries. It enjoys a leadership position in farm equipment, utility SUVs, information technology and financial services in India and is the world's largest tractor company by volume. It has a strong presence in renewable energy, agriculture, logistics, hospitality, and real estate.

The Mahindra Group has a clear focus on leading ESG globally, enabling rural prosperity and enhancing urban living, with a goal to drive positive change in the lives of communities and stakeholders to enable them to Rise.

Learn more about Mahindra on www.mahindra.com / Twitter and Facebook: @MahindraRise/
For updates subscribe to <https://www.mahindra.com/news-room>.

Media contact information

Neha Anand

Head, Global Brand and Marketing Communication, Automotive Division

Email – anand.neha@mahindra.com

You can also write to us on: automedienquiries@mahindra.com