



RACL Geartech Ltd.

Corporate Office

B-9, Sector-3, Noida, Uttar Pradesh-201301, INDIA

Phone: +91-120-4588500 Fax: +91-120-4588513

Web: www.raclgeartech.com E-mail: info@raclgeartech.com

Date: 26th February, 2024

**The Manager - Listing
BSE Limited
25th Floor, P. J. Towers,
Dalal Street,
Mumbai-400 001**

Scrip Code: 520073

Subject: Investor Conference Call and Investor Presentation

Dear Sir/ Madam,

Pursuant to Regulation 30 of the SEBI (Listing Obligations and Disclosure Requirements) Regulations, 2015, it is hereby informed that the Company conducted an Investor Conference Call on 26th February, 2024. The Investor Presentation for the same is annexed herewith. The Audio Recording of the Conference Call has been placed on the Website of the Company at www.raclgeartech.com.

This is for your information and record please.

Thanking You,

For RACL Geartech Limited

JITENDER Digitally signed by
JITENDER JAIN
JAIN Date: 2024.02.26
18:22:49 +05'30'

**Jitender Jain
Chief Financial Officer**

Registered Office

15th Floor, Eros Corporate Tower, Nehru Place, New Delhi-110019, INDIA

Phone: +91-11-66155129

CIN: L34300DL1983PLC016136

D-U-N-S Number: 65-013-7086



TS 16949 : 2009
TS 518901 : 000



RACL Geartech Limited

Putting the world to motion



Investor Interaction

Q3 FY 2023-24

OVERVIEW



Established

1983
New Delhi
DUNS 65-013-7086



Business Highlights

FY23 Revenue
INR 3.67 billion (USD 44.26 million)
599 employees

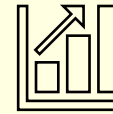

Product Application

Two Wheelers, Three Wheelers, Passenger Cars, Commercial Trucks, ATV's, Agricultural Equipment, Industrial Gears

22 Active Customers ; **900+** SKU's

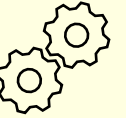

Headquartered in, Noida, India



Company Infrastructure

2 Manufacturing Locations
1 Corporate Office
3 Warehouses in Europe



Product Range

Transmission gears and shafts, sub- assemblies, Precision machined parts, Chassis Parts and Industrial Gears



Financial Outlook

A- Credit Rating
BSE Public Listed Co
1 Austrian Subsidiary



Core Competencies

Gear Cutting, Precision Machining, Aluminium Machining, Process R&D & Concurrent engineering, Heat Treatment, sub-assembly, Laser Welding & Laser Cutting, Exports Logistics Handling



Company Certifications

ISO 9001
ISO 14001
IATF 16949
ISO 45001;2018





FINANCIAL PERFORMANCE

QUARTERLY RESULTS (Q3 FY23-24)

Q3 Results

Total Revenue for Q3 FY 23-24



Sales (INR Cr)

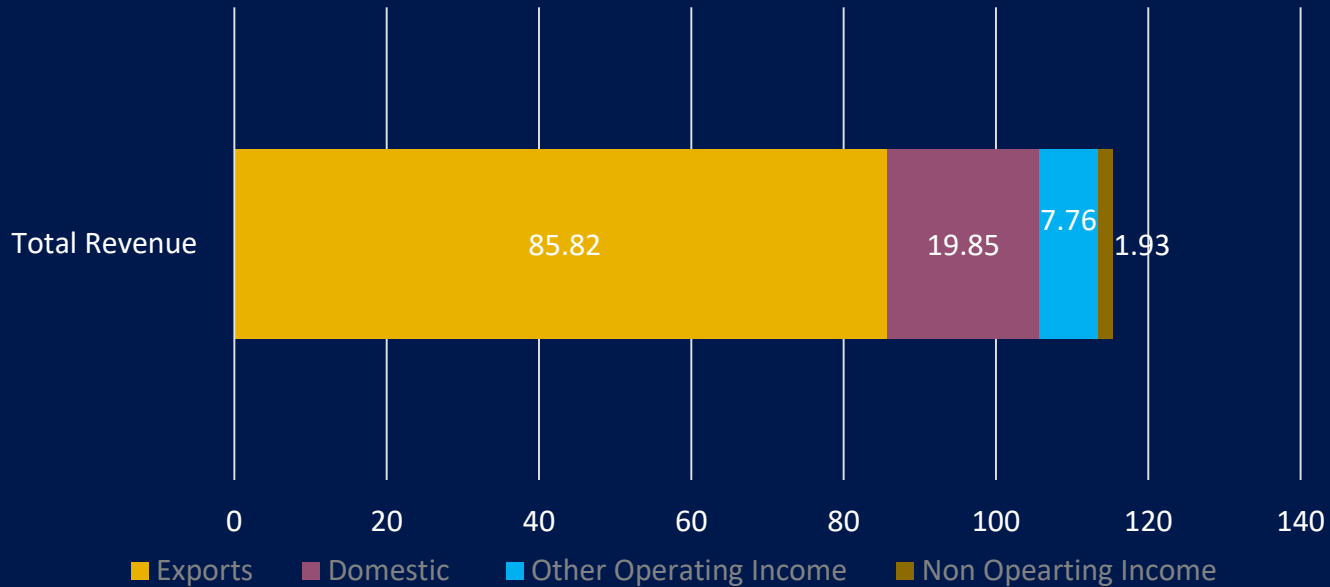

Sales Segment %

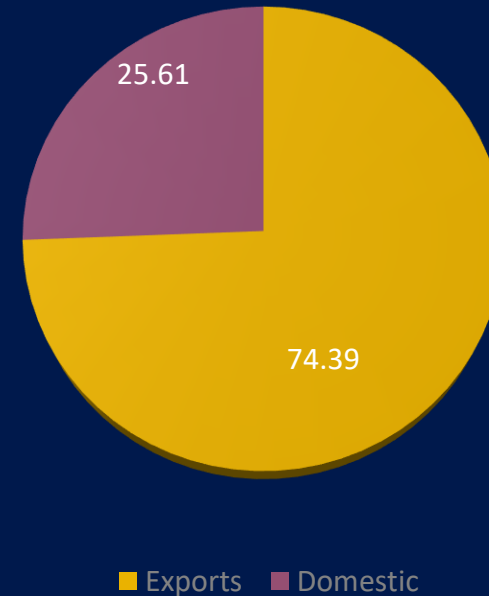

TOTAL SALES: 115.36 CRORE

Q3 Results

YoY Q3 Sales & Profitability for FY 23-24



Q3 SALES INR Cr.

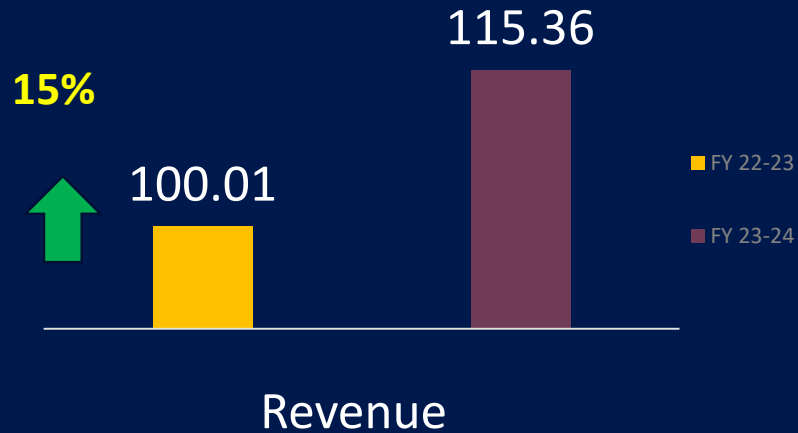

Q3 EBITDA (INR Cr)

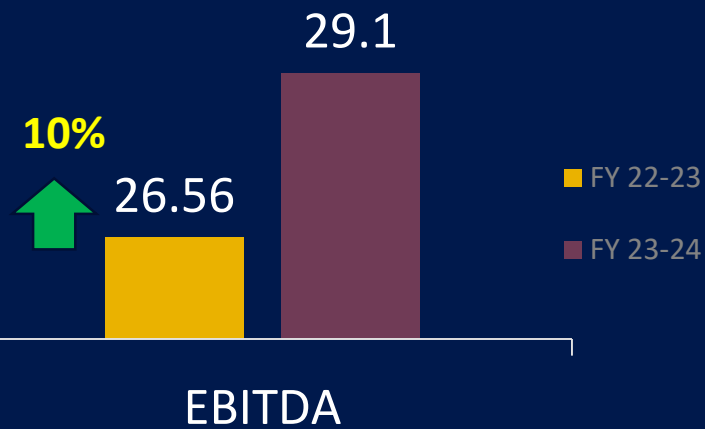

Q3 PBT (INR Cr)

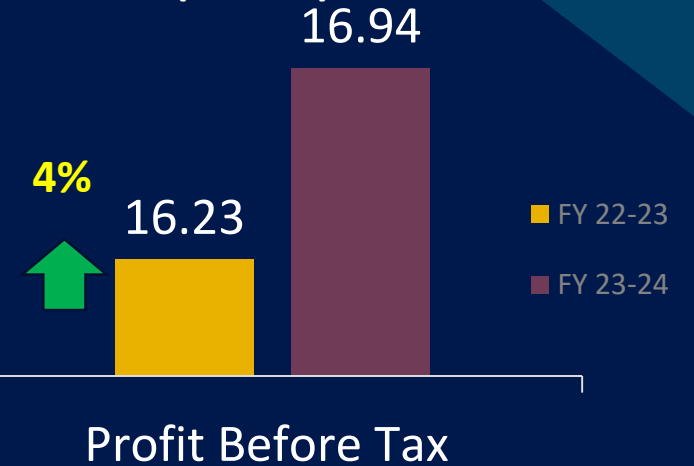

Nine Months Results

YoY Nine Months Sales & Profitability for FY 23-24



YoY Sales (INR Cr)

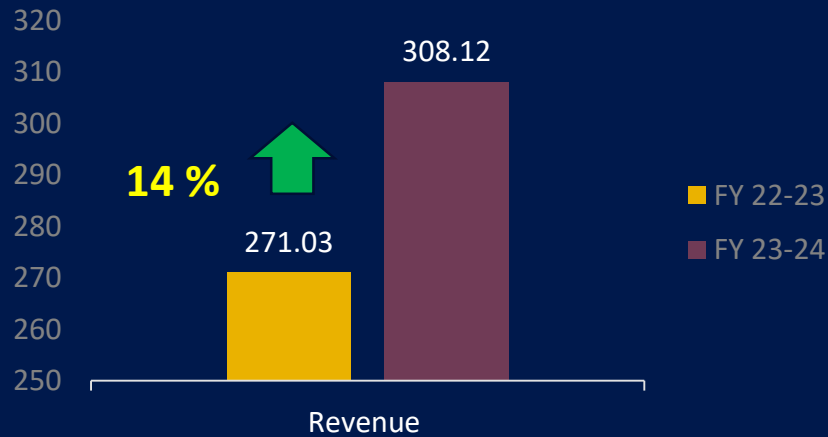

YoY EBITDA (INR Cr)

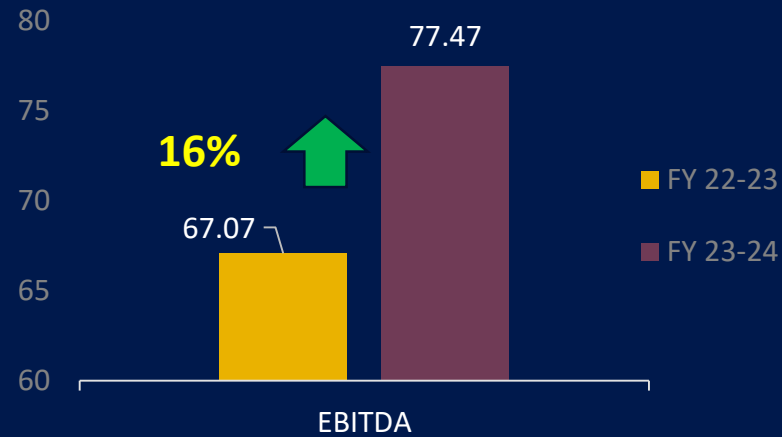

YoY PBT (INR Cr)

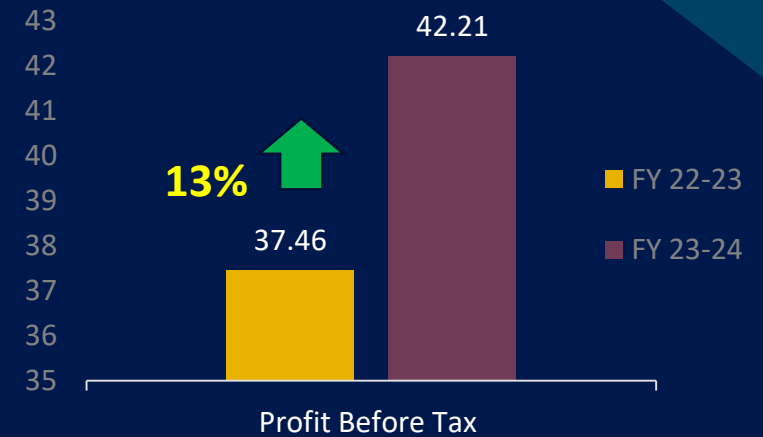

Q3 Results

Standalone Q1 Vs.Q2 Vs. Q3 Sales & Profitability for FY 23-24



Sales (INR Cr)

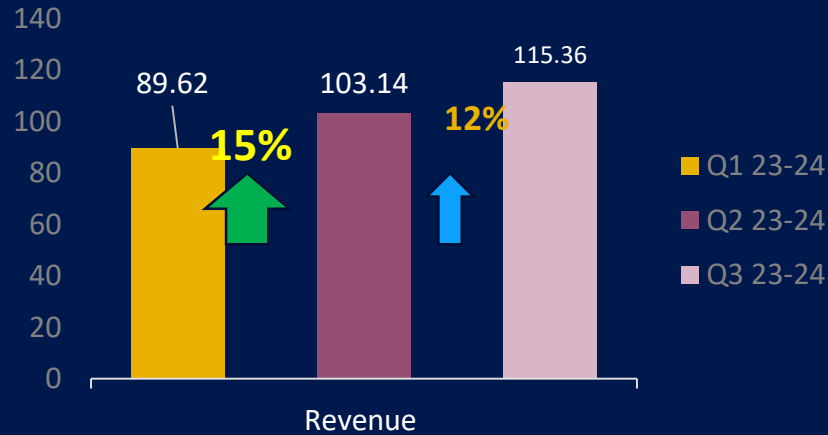

EBITDA (INR Cr)

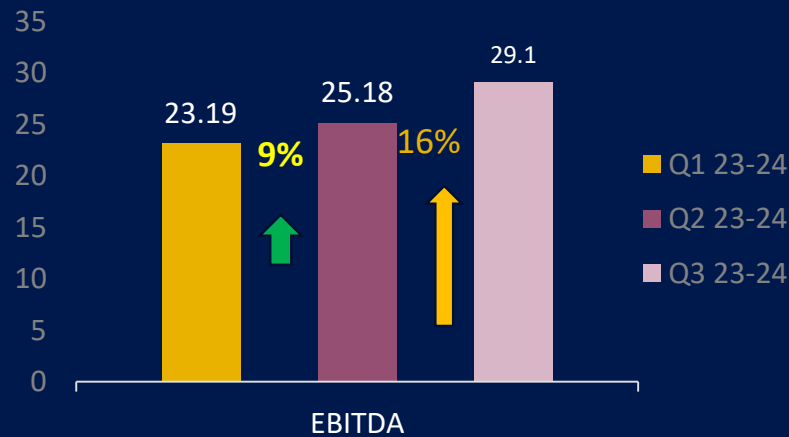

PBT (INR Cr)

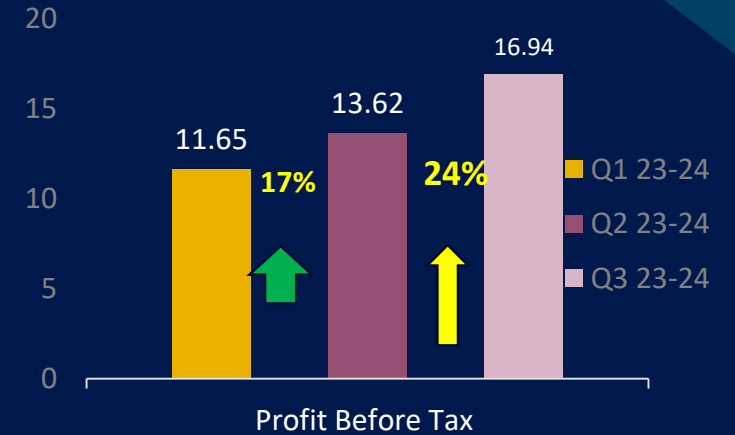



LATEST DEVELOPMENTS

Business Update

TIER 1 SUPPLIER FOR ELECTRIC SPORTS CAR

- Nominated as a series supplier for premium German car manufacturer for supply of Parking Lock Mechanism for its next generation electric sports car.
- SOP FY 2026-27 ; USD 38 million Total Lifetime Order Value

**From a
component
supplier to sub
system supplier**

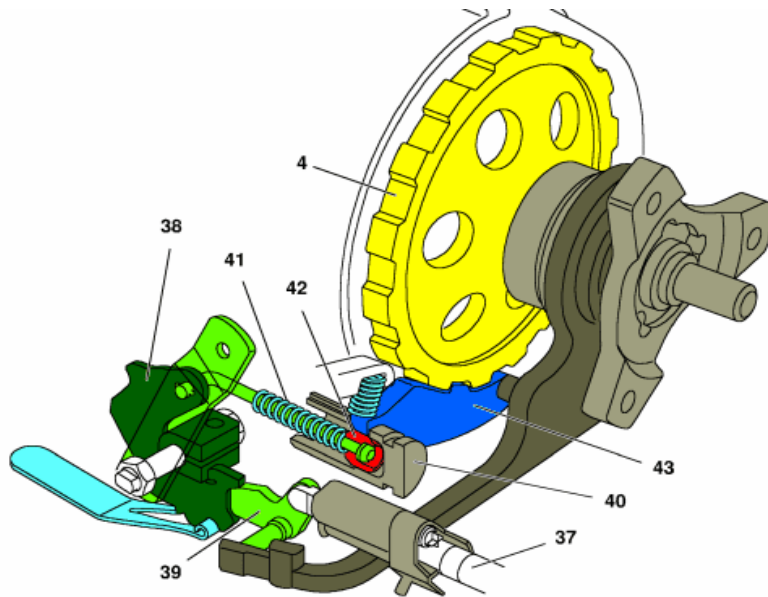

Parking Lock Mechanism is a mechanical device that is placed in vehicle with automatic transmission to prevent un-intentional rollback of the vehicle when the vehicle is brought to a stop.

The above picture is a representative concept.
Actual design is confidential and shall be different.

INAUGURATION OF PLANT II, NOIDA

Formally Inaugurated on Monday, February 26, 2024 in the presence of a premium German buyer.



NOIDA UNIT II – BROWNFIELD EXPANSION

- 1.5 times of existing area
- 26,000 sqft in the hub of Noida, 30 mins away from Dry Port
- Equipped with clean room & vacant space for future expansion

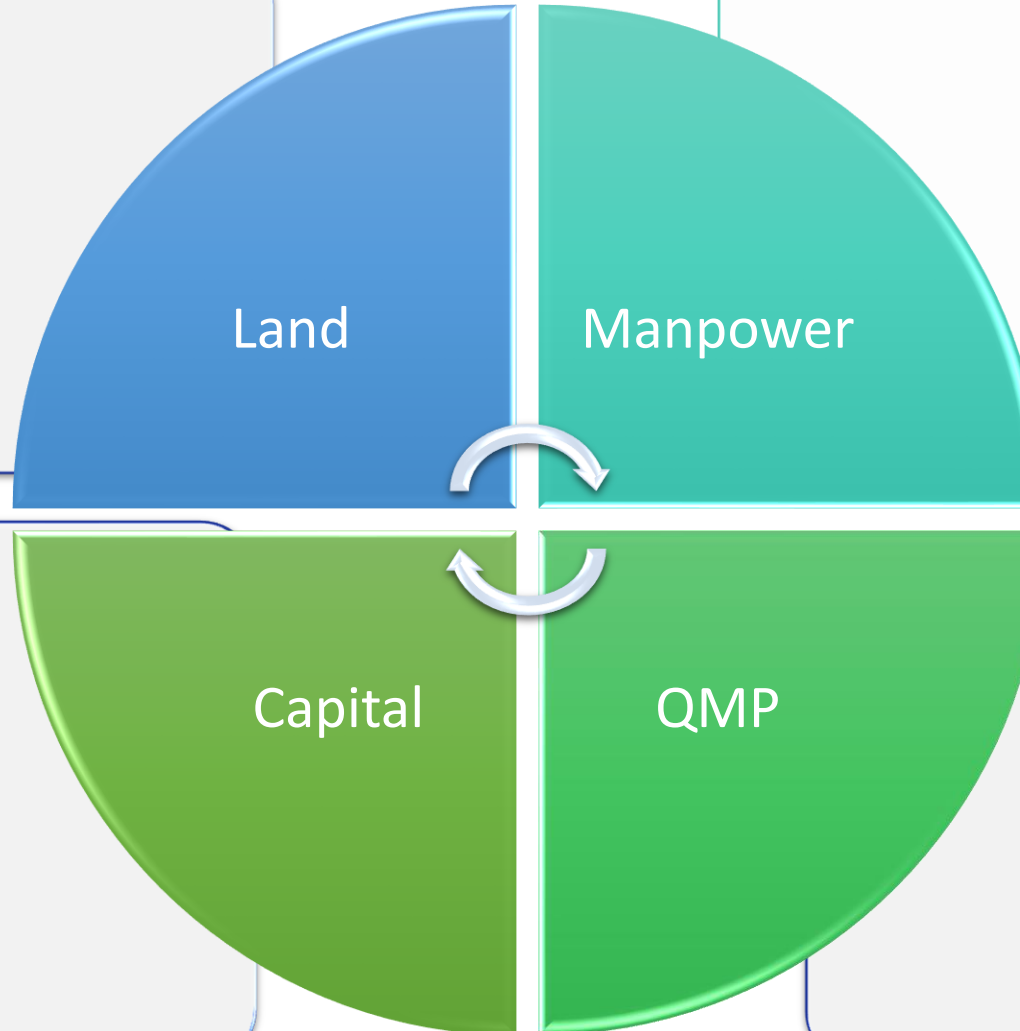

- Double manpower from 120 to 250 people.
- Highly skilled manpower due to location near SEZ
- Dedicated project & NPD team to reduce queuing and ensure On time sample development.

- USD One million investment for new plant with 60% for electric cycle project.

- ISO 14000, OHSAS to be undertaken within one year
- Barcode traceability system for internal WIP movement

COMPANY OPERATED WAREHOUSE AT AUSTRIA



- Company has taken a warehouse on rent and has entered into an understanding with our existing customer KTM Austria to provide additional value-added services including warehousing through RACL Geartech GmbH Austria, a wholly owned subsidiary of RACL Geartech Limited.
- RACL Geartech Limited will supply goods to RACL Geartech GmbH who in turn will supply goods after value added services of warehousing & Local Invoicing as per the new weekly demands.



GREEN ELECTRICAL ENERGY COMPLIANT



	Current	From Apr-24
Electricity Board (MW)– 100% Green (Dec'23)	94%	52%
Captive Solar Open System (4MW)(DC)	-	35%
Renewable Solar Roof Top Generation (1.2 MW)	4%	11%
Non Renewable Power generation (Emergency in case of Power cut)	2%	2%

RACL ,Gajraula plant has achieved 100% Green Electrical Energy compliance

AWARDS & RECOGNITION

- Won First Prize in the category of Engineering and Builders Hardware in recognition of Highest Export Performance for the Financial Year 2022-23.
- The award was conferred by Department of Micro, Small And Medium Enterprise and Export Promotion, Uttar Pradesh Government.



BMW GS TROPHY INDIA QUALIFIER 2023



- RACL Geartech Limited was one of the title sponsor and official partner for the 2023 BMW GS Trophy India Qualifier in partnership with BMW Motorrad.
- This event was exclusively for BMW GS motorcycle owners and has gained global recognition since its inception in 2010.
- This year around 22 teams with a total of 60 riders from around the world had competed in this thrilling competition.

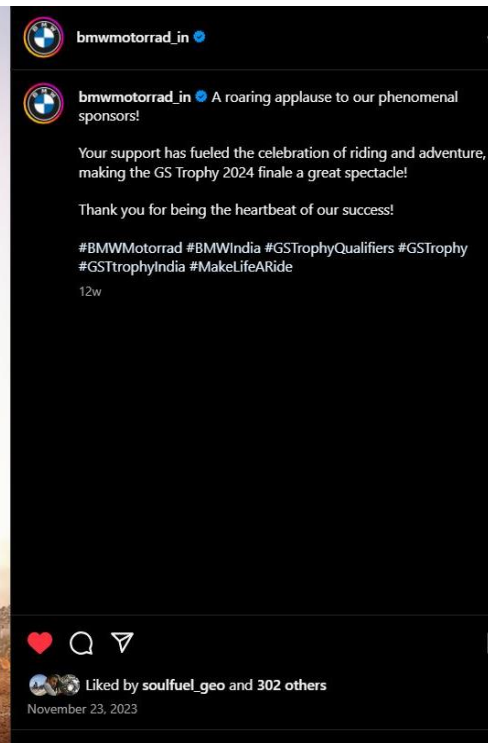

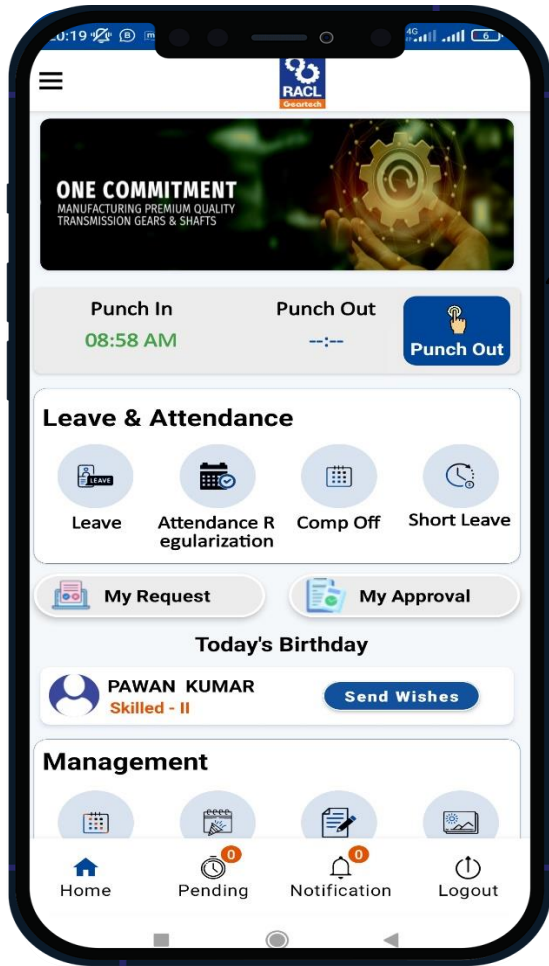

Feature

1. Attendance record
2. Salary Slip
3. Birthday Notification
4. Suggestions

Feature

1. Efficiency
2. Production report
3. Operator Effi.

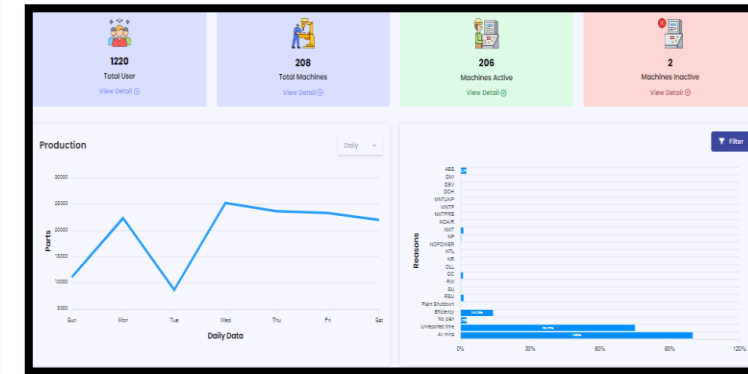
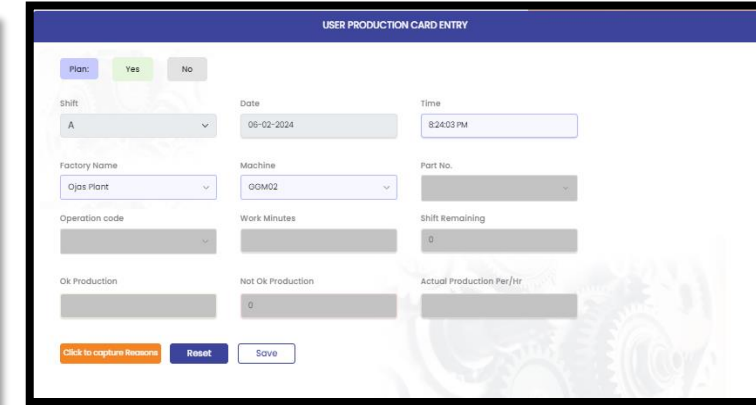

Online HRMS Application

Online production Monitoring-Paperless company

INTERNET OF THINGS (IOT) WORKING ON GGM02

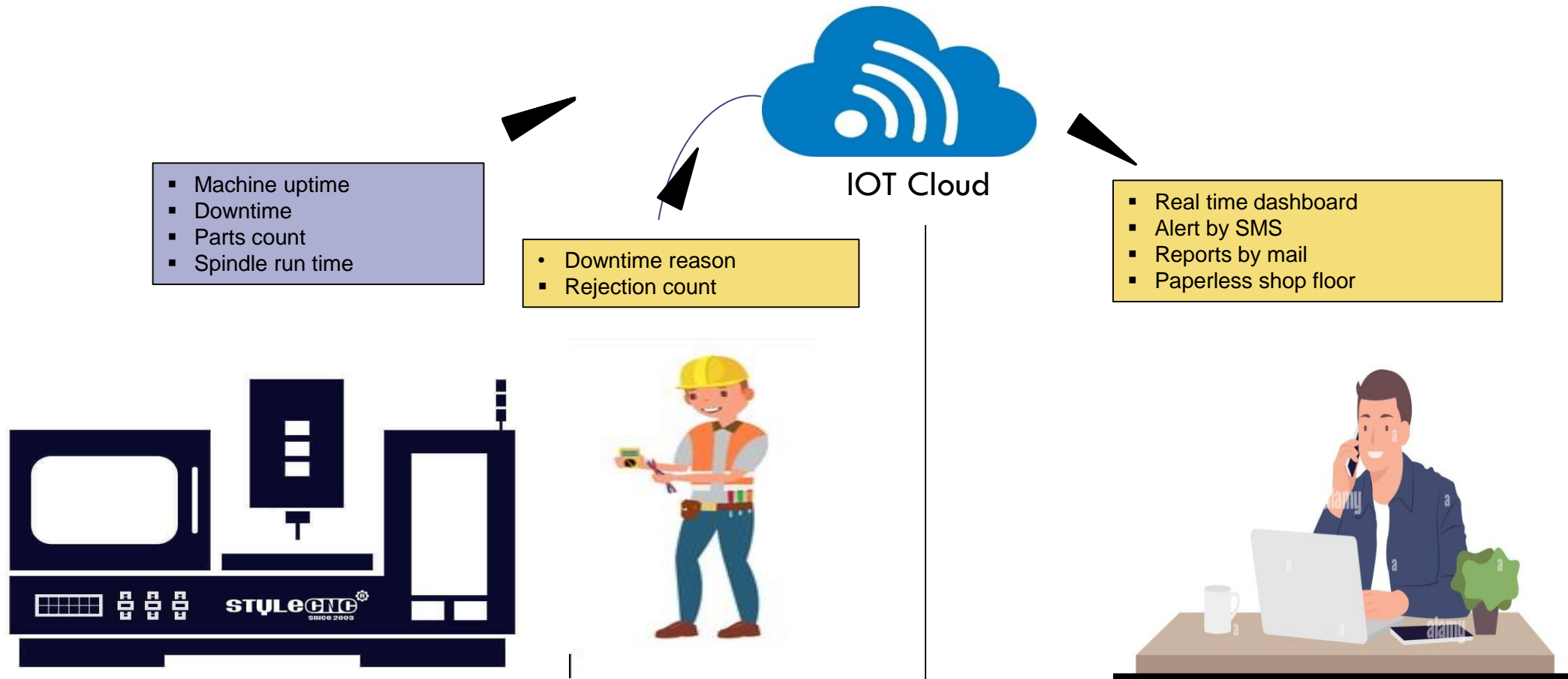

THANK YOU!



RACL Geartech Limited

Registered Office: 15th Floor, Eros Corporate Tower Nehru Place, New Delhi

Corporate Office: B-9 Sector-3, Noida, Uttar Pradesh

Plant 1: A-3 Industrial Area, Gajraula, Amroha

Plant 2: C- 32, Sector 80, Noida, Uttar Pradesh

Austria Office: 38, Haufstrasse, 4550, Kremsmunster, Kalsdorf, Upper Austria