

LATL:CS:IP:2021-22

BSE Limited Listing & Compliance Department Phiroze Jeejeebhoy Towers, Dalal Street, Mumbai - 400001	The National Stock Exchange of India Limited Listing & Compliance Department Exchange Plaza, C-1 Block G, Bandra Kurla Complex, Bandra (E), Mumbai – 400051
Security Code : 532796	Symbol: LUMAXTECH

Subject: Investor Presentation for the 2nd Quarter and Half Year ended on 30th September, 2021

Dear Sir/ Ma'am,

Please find enclosed herewith the Investor Presentation of the Company for the 2nd Quarter and Half Year ended on 30th September, 2021.

The same shall also be made available on the website of the Company www.lumaxworld.in/lumaxautotech.

This is for your information and records.

Thanking you,

Yours faithfully,

For LUMAX AUTO TECHNOLOGIES LIMITED



ANIL TYAGI
COMPANY SECRETARY
M. NO. A 16825



Encl: As Stated above



Lumax Auto Technologies Limited

Investor Presentation – Q2 FY2122



This presentation and the accompanying slides (the “Presentation”), which have been prepared by **Lumax Auto Technologies Limited** (the “Company”), have been prepared solely for information purposes and do not constitute any offer, recommendation or invitation to purchase or subscribe for any securities, and shall not form the basis or be relied on in connection with any contract or binding commitment whatsoever. No offering of securities of the Company will be made except by means of a statutory offering document containing detailed information about the Company.

This Presentation has been prepared by the Company based on information and data which the Company considers reliable, but the Company makes no representation or warranty, express or implied, whatsoever, and no reliance shall be placed on the truth, accuracy, completeness, fairness and reasonableness of the contents of this Presentation. This Presentation may not be all inclusive and may not contain all of the information that you may consider material. Any liability in respect of the contents of, or any omission from, this Presentation is expressly excluded.

Certain matters discussed in this Presentation may contain statements regarding the Company’s market opportunity and business prospects that are individually and collectively forward-looking statements. Such forward-looking statements are not guarantees of future performance and are subject to known and unknown risks, uncertainties and assumptions that are difficult to predict. These risks and uncertainties include, but are not limited to, the performance of the Indian economy and of the economies of various international markets, the performance of the industry in India and world-wide, competition, the company’s ability to successfully implement its strategy, the Company’s future levels of growth and expansion, technological implementation, changes and advancements, changes in revenue, income or cash flows, the Company’s market preferences and its exposure to market risks, as well as other risks. The Company’s actual results, levels of activity, performance or achievements could differ materially and adversely from results expressed in or implied by this Presentation. The Company assumes no obligation to update any forward-looking information contained in this Presentation. Any forward-looking statements and projections made by third parties included in this Presentation are not adopted by the Company and the Company is not responsible for such third party statements and projections.



Lumax-DK Jain Group



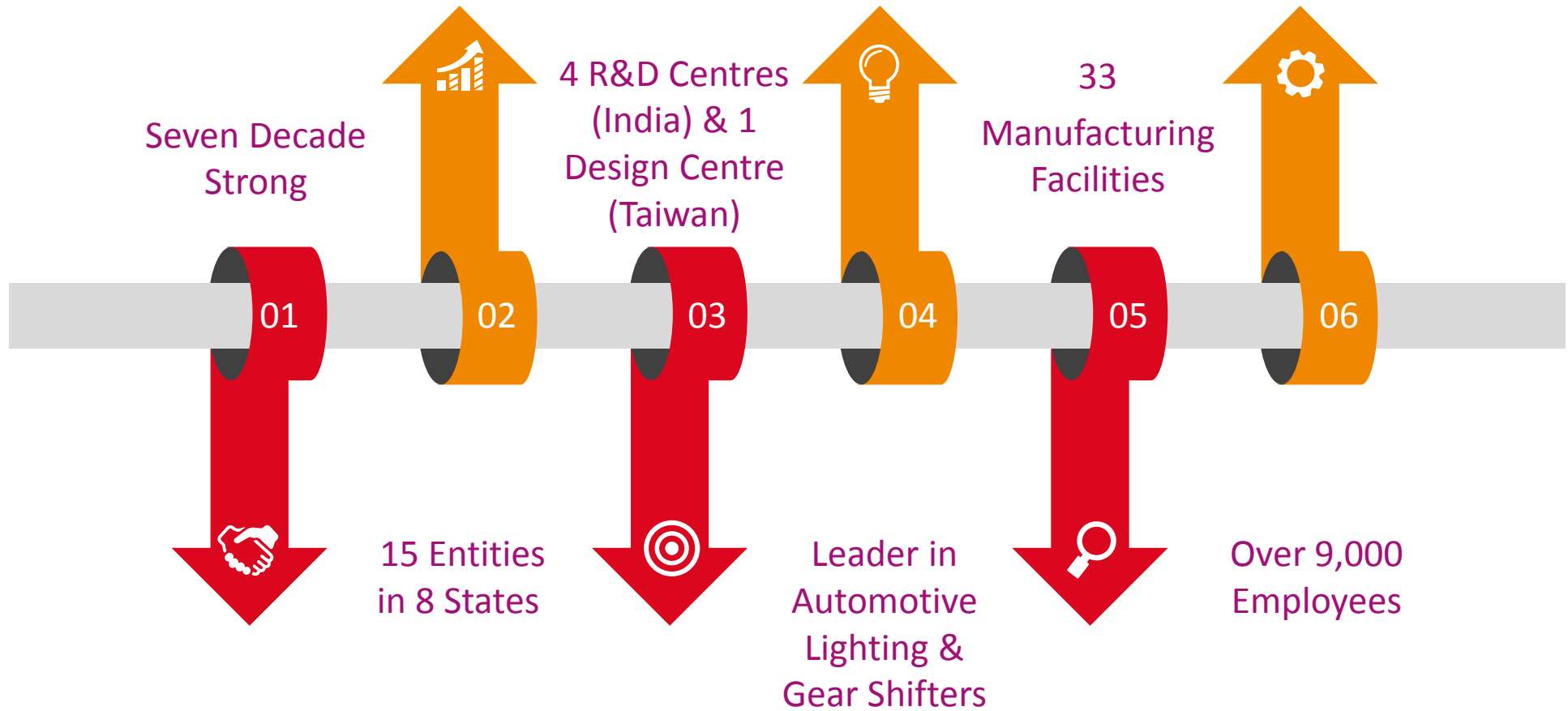

Two Listed Entities



Lumax Industries Limited

Products & Services

End-to-end Automotive Lighting Solutions

HVAC Panels and other electronic components

Partnerships

- Stanley – Japan
- SL Corporation - Korea

Lumax Auto Technologies Limited

Products & Services

Integrated Plastic modules, 2-wheeler Chassis, 2/3-wheeler Lighting, Gear Shifters, Emission systems, Transmission Products, Seat Frames, Aftermarket, Telematics Products and Services, Oxygen Sensors, On-board Antennas, Electric devices and components including software related to automotive industry

Partnerships

- Cornaglia – Italy
- Mannoh – Japan
- Ituran – Israel
- FAE – Spain
- JOPP – Germany
- YOKOWO – Japan
- Alps Alpine – Japan

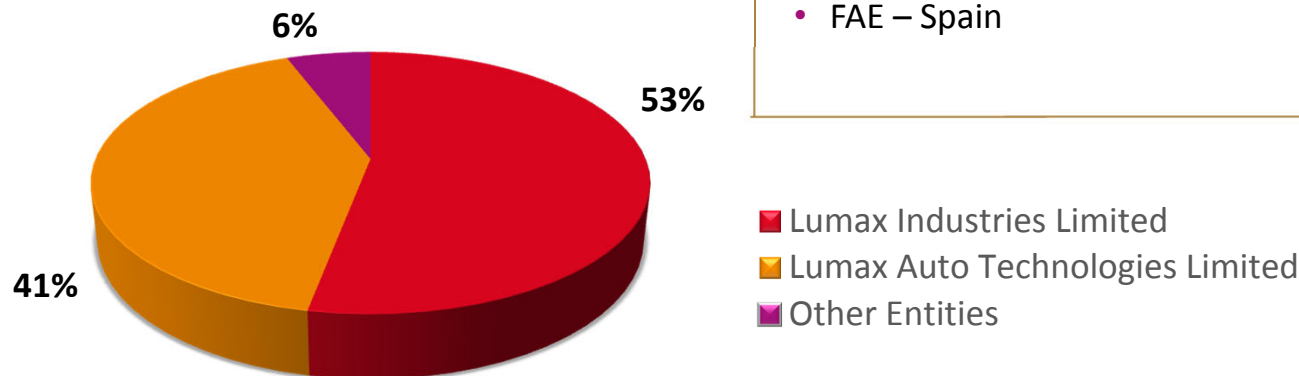

FY21 Group Revenue Break Up (%)



We deliver **PRIDE** and
PROGRESS with
POSITIVITY



**Our
Group
Purpose**

Respect
Integrity
Passion
Excellence



**Our
Values**

Building an **ADMIRE**
HIGH PERFORMANCE
Global Organisation in
whom all stakeholders
have **ABSOLUTE TRUST**



**Our
Vision**



Diversified Product Range – 4-wheelers

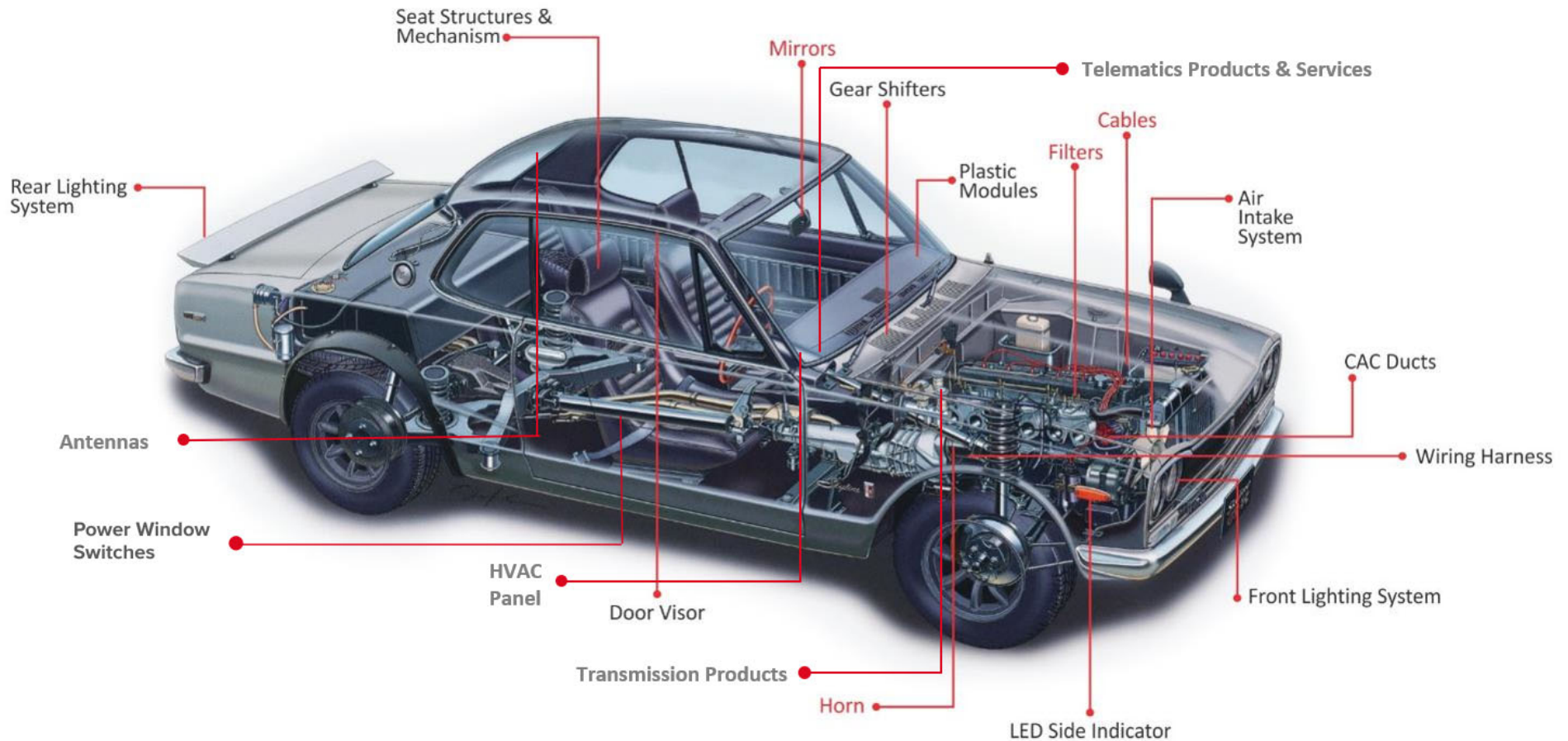

- Destination Boards & Urea Tanks for Commercial Vehicle
Aftermarket products

Diversified Product Range – 2-wheelers

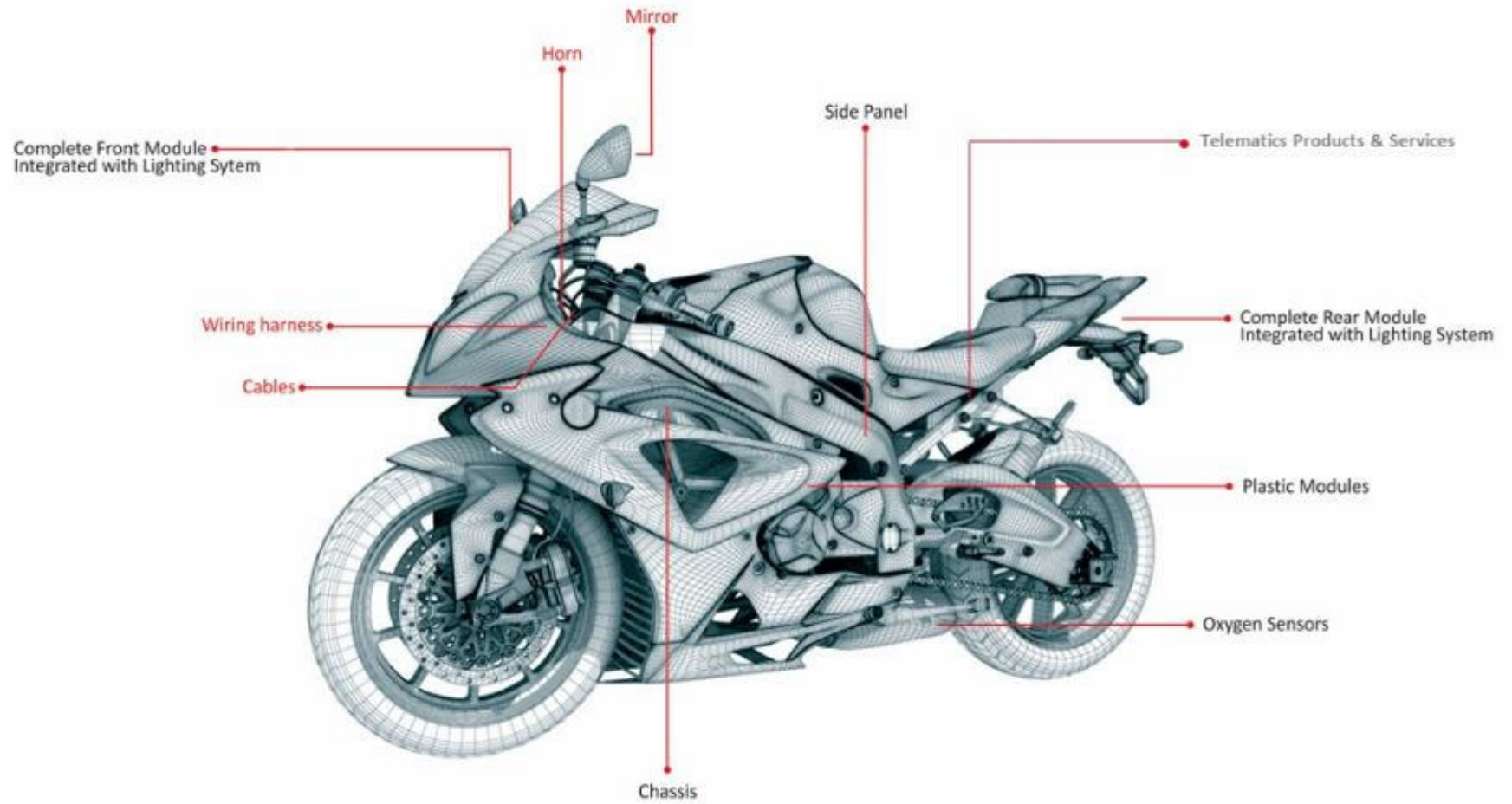

■ *Aftermarket products*

Diversified Product Range – Commercial Vehicles

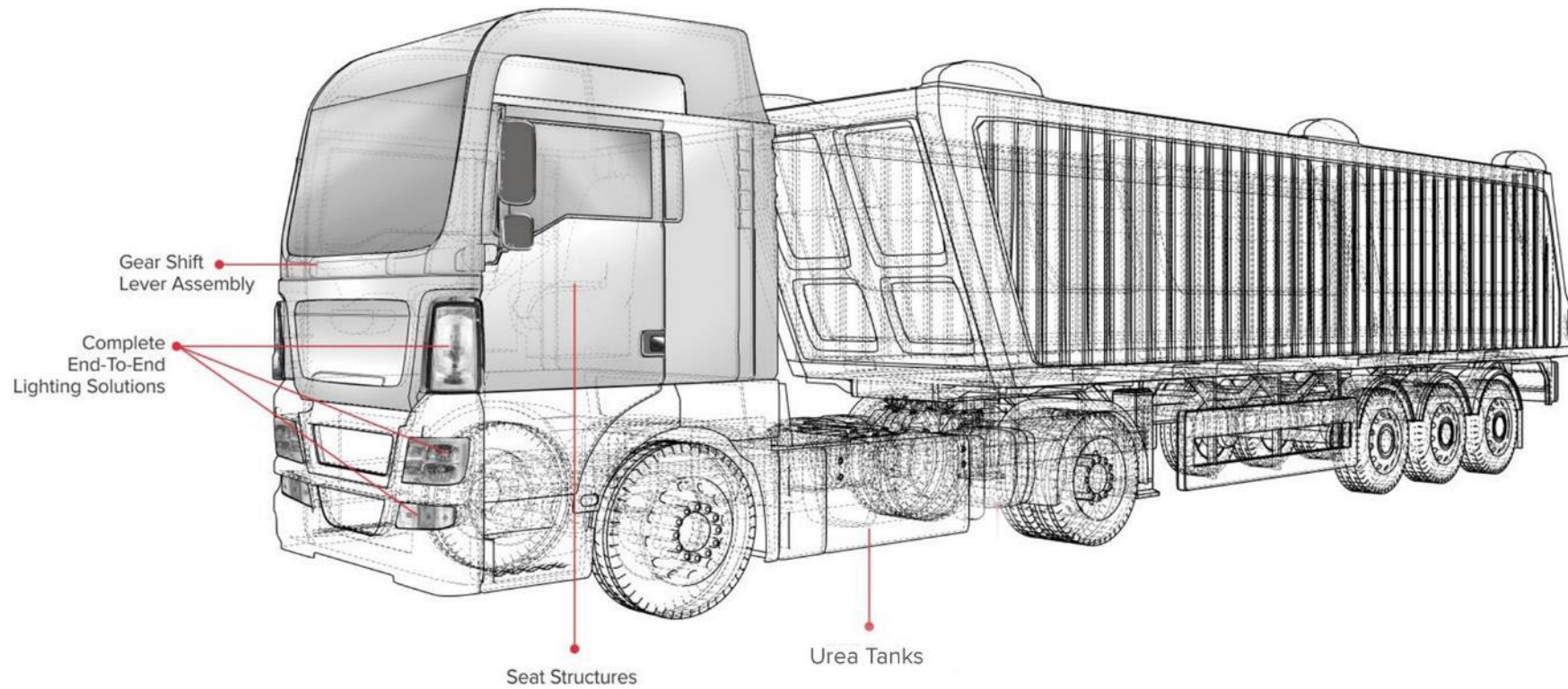

Diversified Product Range – Farm Equipment Sector (FES)



33 Locations close to Customers

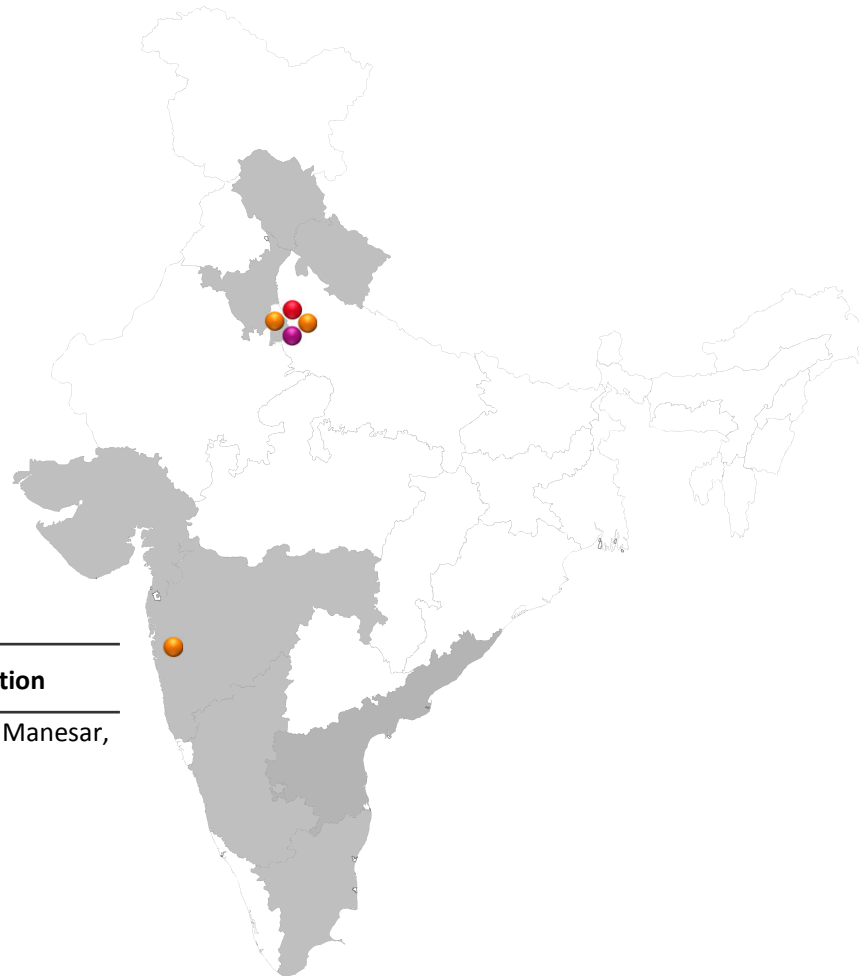

Facilities	Location
● R&D Centre	Gurugram, Manesar, Pune
● Design Centre	Taiwan
● Corporate HQ	Gurugram
● After Market Division	Gurugram

State	Mfg Locations	#
Haryana	Bawal	1
	Dharuhera	1
	Gurugram	3
	Manesar	4
Maharashtra	Pune	9
	Waluj	3
Karnataka	Bengaluru	2
Gujarat	Sanand	1
	Mehsana	1
Tamil Nadu	Sriperumbudur	1
Andhra Pradesh	Anantpur	1
Uttarakhand	Haridwar	1
	Pantnagar	4
Himachal Pradesh	Kale Amb	1
Total		33

33 Plants in 8 States

Lumax Industries Limited & Lumax Auto Technologies Limited, along with its subsidiaries, JVs & Associates

Map not to scale. All data, information and maps are provided "as is" without warranty or any representation of accuracy, timeliness or completeness

Fostering Partnerships to Deliver Excellence



Japan

Relationship Since 1984
JV for lighting, HVAC panels and other electronics
37.5% in Lumax Industries Ltd.



Korea

Relationship Since 1997
JV for lighting and other automotive parts
78.72% in SL Lumax Ltd.



Italy

Relationship Since 2007
JV for emission systems
50% in Lumax Cornaglia Auto Technologies Pvt. Ltd.



Japan

Relationship Since 2008
JV for gear shifters
45% in Lumax Mannoh Allied Technologies Ltd.



Israel

Relationship Since 2017
JV for sale of telematics products and services
50% in Lumax Ituran Telematics Pvt. Ltd.



Spain

Relationship Since 2017
JV for oxygen sensors
49% in Lumax FAE Technologies Pvt. Ltd.



Germany

Relationship Since 2019
JV for manufacture and supply of transmission products
50% in Lumax Jopp Allied Technologies Ltd.



Japan

Relationship Since 2020
JV for manufacture and supply of antennas & other vehicle communication products



Japan

July 2021
JV for manufacture and supply of electric devices and components
50% in Lumax Alps Alpine India Pvt. Ltd.

Relationships with Diversified Customers



Two Wheeler



Tier 1



Four Wheeler



Commercial Vehicle



Tractor/FES



Defence & Aero Space



Export



... Strong After Market Exports Presence



Lumax Auto Technologies Limited
Driving Growth through Diversified Products



Competitive Strengths



Award

Awarded with Prestigious JIPM Award

Lumax Brand

Renowned LUMAX Brand

Auditors

Statutory Auditors - S. R. Batliboi & Co. LLP. & Internal Audit by Deloitte

Customer Outreach

Strong OEM presence
Over 300 Channel Partners

R&D Centre

Govt certified R&D center

Products & Services

Integrated Plastic modules, 2-wheeler Chassis & Lighting, Gear Shifters, Transmission Products, Emission Systems, Seat Frames, Aftermarket, Oxygen sensors, Telematics Products, Antennas & other vehicle communication products, Electric devices & components

Manufacturing Capabilities

Manufacturing Plants with Quality Certifications across India

Partnerships

7 Successful Partnerships with Global Players

Milestones

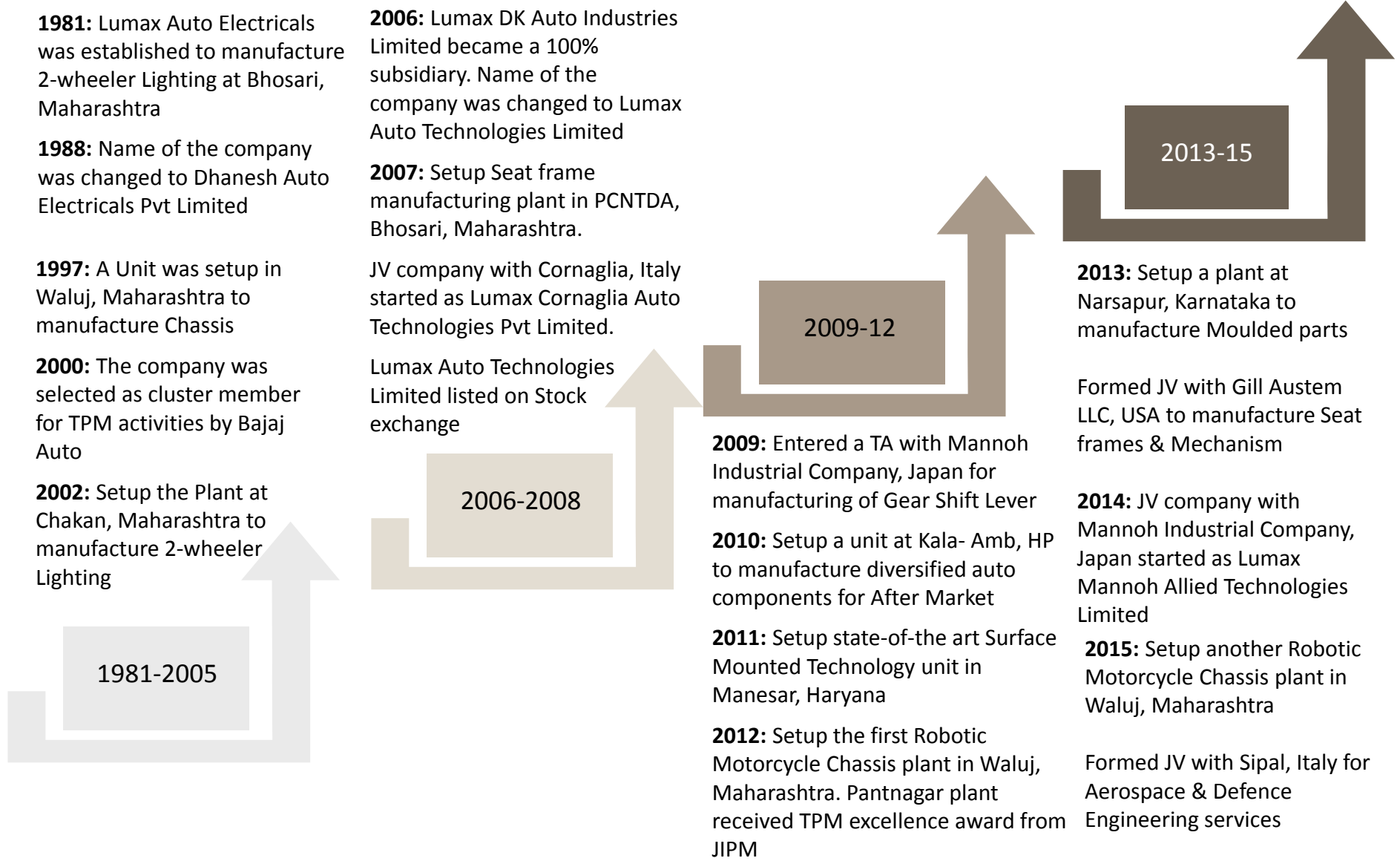

Milestones



2016: Pantnagar plant received TPM consistency award from JIPM

2017: Chakan plant received TPM excellence award from JIPM

Formed a JV with Ituran Location and Control Limited, Israel to provide Telematics Products and Services

Formed a JV with FAE, Spain to manufacture Oxygen Sensors

Set up Assembly facility in Mehsana, Gujarat under LMAT

2018: Setup an R&D center under Lumax Cornaglia Auto Technologies Pvt Limited at Pune

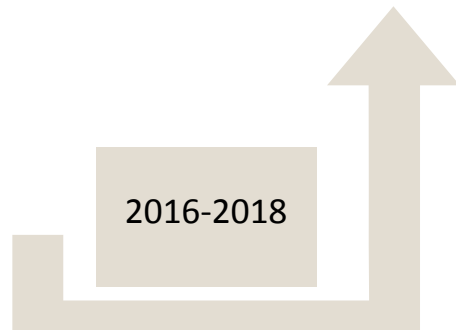

2019: Inauguration of Chassis facility at Aurangabad

JV with JOPP, Germany to manufacture and supply transmission products to the Indian automotive industry

Subsidiary entity Lumax DK Auto Industries Limited merged with the Standalone entity

Bengaluru plant received TPM consistency award from JIPM

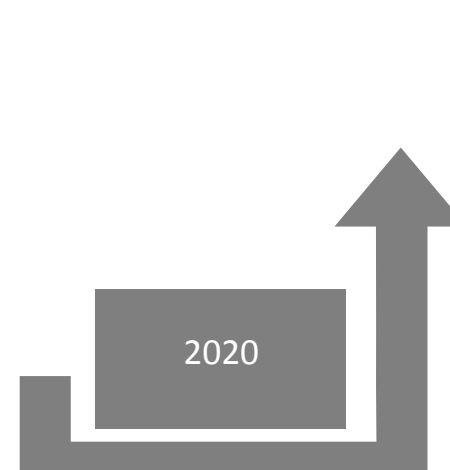
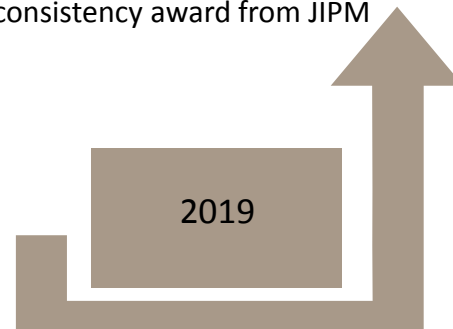

2020: Bengaluru plant has been awarded JIPM-TPM Excellence award

JV with Yokowo, Japan to manufacture and supply Antennas and other vehicle communication products

Start of Commercial Production in Pantnagar, Uttarakhand under LCAT
Start of Commercial Production by Lumax FAE

Lumax Gill Austem Technologies Pvt Ltd. name changed to Lumax Mettalics Pvt. Ltd. and becomes 100% subsidiary of LATL.

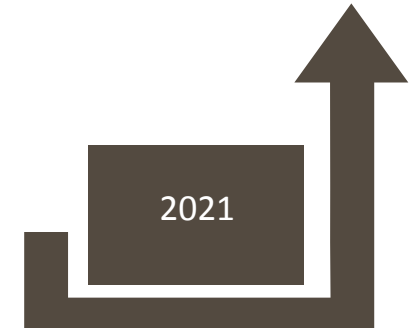

2021: JV with Alps Alpine to manufacture and sell electric devices and components including software related to the automotive industry





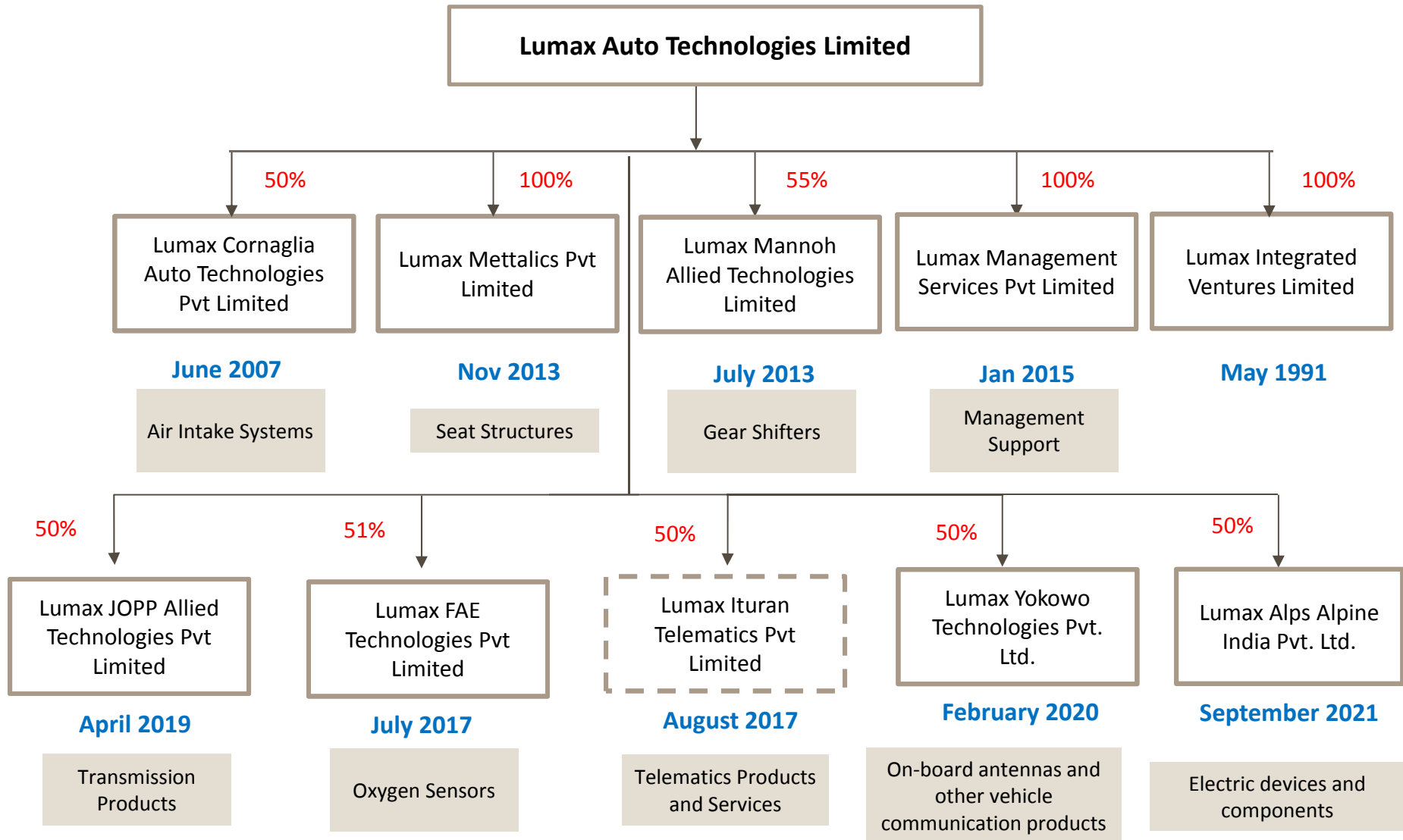



Well defined Corporate Structure



Fostering Partnerships to Deliver Excellence



 <p>Italy</p> <p>JV for Emission Systems</p> <p>Relationship Since 2007</p> <p>50% in Lumax Cornaglia Auto Technologies Pvt Limited</p>	 <p>Japan</p> <p>JV for Gear Shifters</p> <p>Relationship Since 2008</p> <p>45% in Lumax Mannoh Allied Technologies Limited</p>	 <p>Spain</p> <p>JV for Oxygen Sensors</p> <p>2017</p> <p>49% in Lumax FAE Technologies Pvt Limited</p>	 <p>Israel</p> <p>JV for Telematics Products and Services</p> <p>2017</p> <p>50% in Lumax Ituran Telematics Pvt Limited</p>
--	---	--	--

 <p>Germany</p> <p>JV for Gear Shift Towers, AMT Kits & AGS</p> <p>2019</p> <p>50% in Lumax JOPP Allied Technologies Pvt Limited</p>	 <p>Japan</p> <p>JV for Antennas & other Vehicle Communication Products</p> <p>2020</p> <p>50% in Lumax Yokowo Technologies Pvt Limited</p>	 <p>Japan</p> <p>JV for manufacture and supply of electric devices and components</p> <p>2021</p> <p>50% in Lumax Alps Alpine India Pvt Limited</p>
---	--	--

Cater to Diversified Segments



- ✓ Lighting Module(incl. HL/TL/Indicators & Others)
- ✓ Chassis for 2-wheelers
- ✓ Fabricated parts for 3-wheelers
- ✓ Integrated Plastic Modules
- ✓ Oxygen Sensors
- ✓ Telematics Products and Services



- ✓ Gear Shift Lever
- ✓ Gear Shift Tower
- ✓ Control Housing
- ✓ Intake Systems
- ✓ Seat Structures
- ✓ Integrated Plastic Modules
- ✓ Telematics Products and Services



- ✓ Integrated Plastic Modules
- ✓ Gear Shift Lever
- ✓ Seat Structures
- ✓ Telematics Products and Services
- ✓ Urea Tank

← After Market Presence in all Segments →

Key Customer Relationships



Four Wheeler



ŠKODA



Tier 1



Commercial Vehicle



Two Wheeler



Export



The Brand Names mentioned are the property of their respective owners and are used here for identification purposes only

Strategic Locations Close to Customers

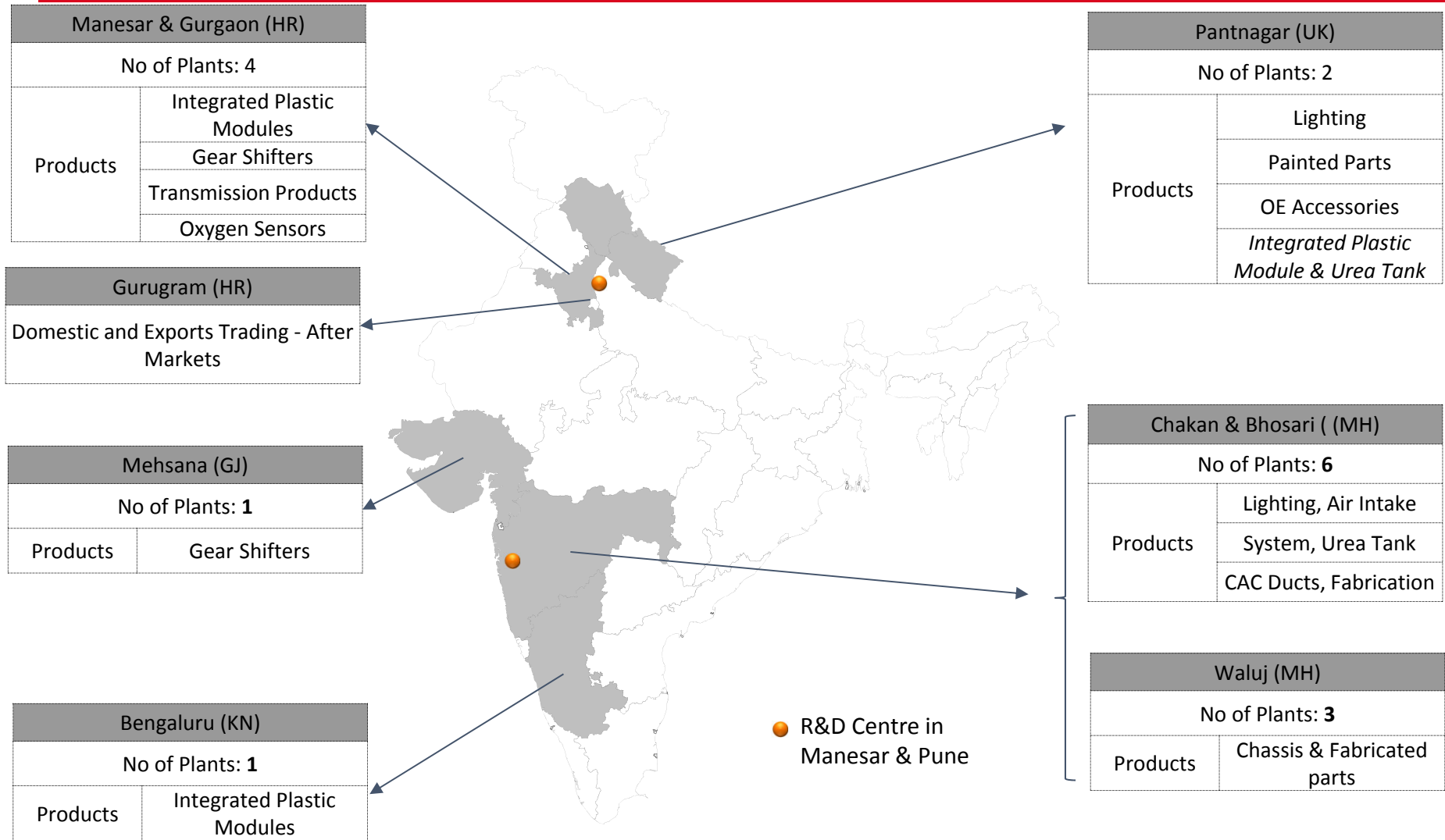

17 Plants in 5 States

Map not to scale. All data, information and maps are provided "as is" without warranty or any representation of accuracy, timeliness or completeness

Shareholding breakup

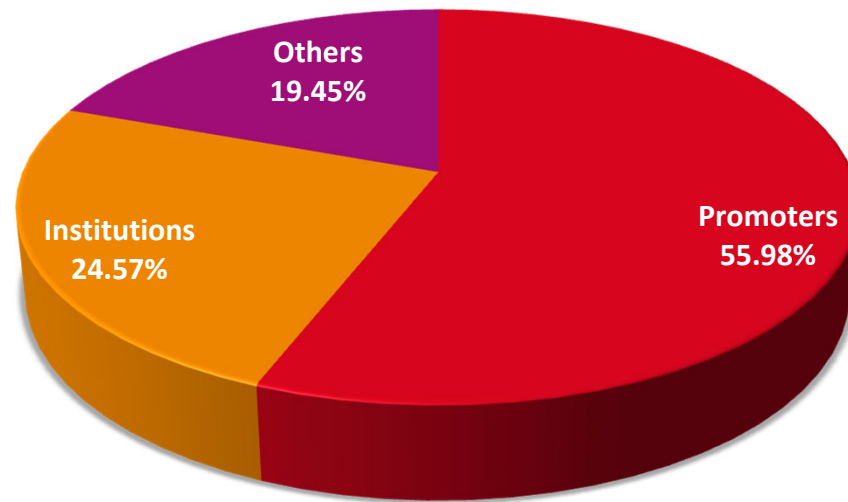

Clear focus on Improving Performance



1

Achieve Leadership in India & Set Sight on the Global Market

2

The Only Gear Shifter Manufacturer in India to have Localised R&D Capability and Gearing to Access the Global Markets

3

Emission Systems – Increase Presence in Domestic Market & Enhance Customer Outreach

4

Seat Frames & 2-Wheeler Chassis – Increase Presence in Domestic Market & Enhance Customer Outreach

5

Diversification – All Diversifications Planned in Future to be under LATL

6

Ramping-up “After Market Business” to see Accelerated Growth

7

Benefits from BS VI

Experienced Promoters



Mr. Dhanesh Kumar Jain
Chairman

- He is 79 years of age & holds a MBA degree from Delhi university & has successfully completed President Management Program from Harvard Business School
- Over 50 years of experience in the automotive industry in management, operations & administrative roles
- He has held various industry positions
- Past president of ACMA, president suppliers association – Toyota Kirloskar Motors, Chairman of Trade Fairs Committee ACMA, Co-chairman of Regional Committee on Membership of Northern Region CII, Past Chairman of CSR sub-committee of the Northern Region of CII



Mr. Anmol Jain
Managing Director

- He is 42 years of age & holds Bachelors in Business Administration in Finance & Supply Chain Management (Double major) from Michigan State University, U.S.A.
- He worked as a Management Trainee with GHSP, U.S.A. & subsequently, joined Lumax Group, in 2000 & has over 20 years of experience
- He has held various positions in Industry associations - He was the National Coordinator of ACMA- YBLF from 2014-16. He was also the Chairman CII Haryana State Council in 2012-13
- He is currently the President of Honda Cars India Supplier's Club & MC member of Bajaj Auto Vendor Association and Executive Council member of ACMA



Mr. Deepak Jain
Director

- He is 46 years of age & is a Business Graduate from Illinois Institute of Technology, USA with specialization in Operations Management & International Business
- He has undergone extensive training at Stanley Co. Limited, U.S.A. & Stanley Electric Co. Limited, Japan. He has over 25 years experience
- He is the immediate Past President of ACMA, he was chairman of ACMA's HR/IR & Skill Development Committee, past chairman of Sustainable Technology Development Committee of ACMA, past National Coordinator of Young Business Leader Forum of ACMA and past president of Supplier's club, Honda Cars India Limited. He is also Chairman - CII Northern Region - Regional Committee on Advanced Manufacturing
- He is member of Young President's organization and Entrepreneurs organization. He also holds the position of Vice President of Toyota Kirloskar Supplier's Association

Supported by Strong Independent Directors



Mr. Roop Salotra

- He is 71 years of age & is a Mechanical Engineer, followed by various Management Development programs
- He retired from SRF Group, after spending 24 years, as CEO & President, is now an advisor to the Managing Director of SRF Limited. He has been actively involved in CII – Climate Change & Environment councils. He is former Chairman of Indian Chemical Council- Northern Region



Mr. Milap Jain

- He is 70 years of age & holds B.A. (Pol.Sc. Hons.) from Ravenshaw College, Cuttack
- He is a retired Indian Revenue Service Officer with 38 years of service. He retired as Chief Commissioner of Delhi, Income Tax Department, Govt. of India. Currently he is a Director of Mahavir International, a NGO

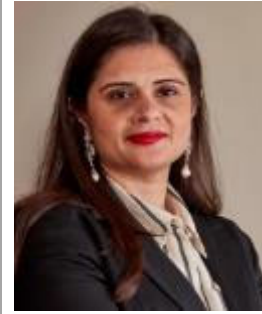

Ms. Diviya Chanana

- She is 51 years of age and she is a Graduate & holds Diploma in Travel and Tourism. She has over 15 years of rich experience in the said field
- She is Executive Director of Damus Travels Private Limited. The Company is engaged in supporting and auxiliary transport activities; activities of travel agencies

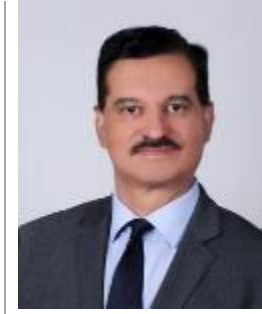

Mr. Arun Malhotra

- He is 63 years of age & holds B.E Mechanical & MBA from IIM, Kolkata
- He is an Indian automotive sector veteran, his last assignment was as the Managing Director of Nissan India and thereafter as Senior Corporate Advisor at Nissan India
- He has over 30 years of experience with organization like Escorts, Bajaj Auto Ltd, and Maruti Suzuki India Ltd



Mr. A P Gandhi

- He is 83 years old & is a mechanical engineer
- He has held top leadership positions in prestigious organisations having over 40 years of experience
- His last assignment was as President at Hyundai Motors India Limited. Prior to that he was Chief Executive –R&D at Escorts Limited & at Telco before that, holding various senior positions in the area of manufacturing operations



Professional & Experienced Team



Mr. Sanjay Mehta
Director & Group CFO
Age: 54 years
Experience: 29 Years



Mr. Vikas Marwah
Chief Executive Officer
Age: 54 years
Experience: 30 Years



Mr. Naval Khanna
Corporate Head – Taxation
Age: 63 years
Experience: 43 years



Mr. Raajesh Gupta
Group Company Secretary
Age: 51 Years
Experience: 28 Years



Mr. Sanjay Bhagat
Head After Market
Age: 54 years
Experience: 29 years



Mr. Atul Jain
Corporate Head - Materials
Age: 52 years
Experience: 29 Years



Mr. Rajesh Dubbwar
Head Metallic
Age: 53 years
Experience: 30+ years



Ms. Priyanka Sharma
Corporate Communication
Age: 52 years
Experience: 26 Years



Mr. Anil Tyagi
Company Secretary
Age: 49 years
Experience: 22 years



Mr. Ashish Dubey
Chief Financial Officer
Age: 53 years
Experience: 29 Years



Financial Performance



Product-wise Revenue Q2FY22



Product-wise Revenue mix Q2FY21
(Rs. 284 Crores)

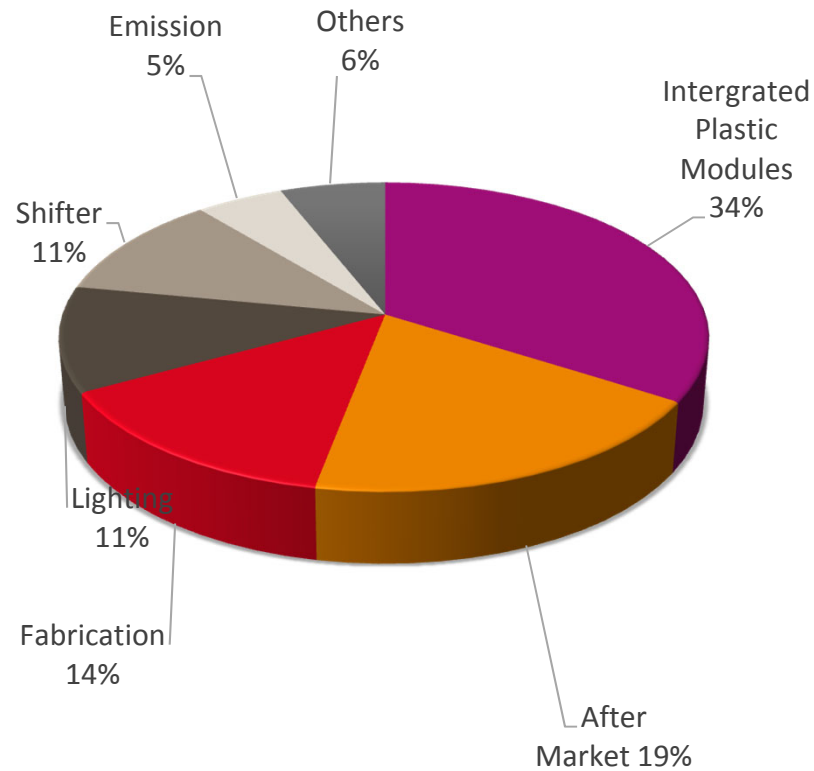

Product-wise Revenue mix Q2FY22
(Rs. 403 Crores)

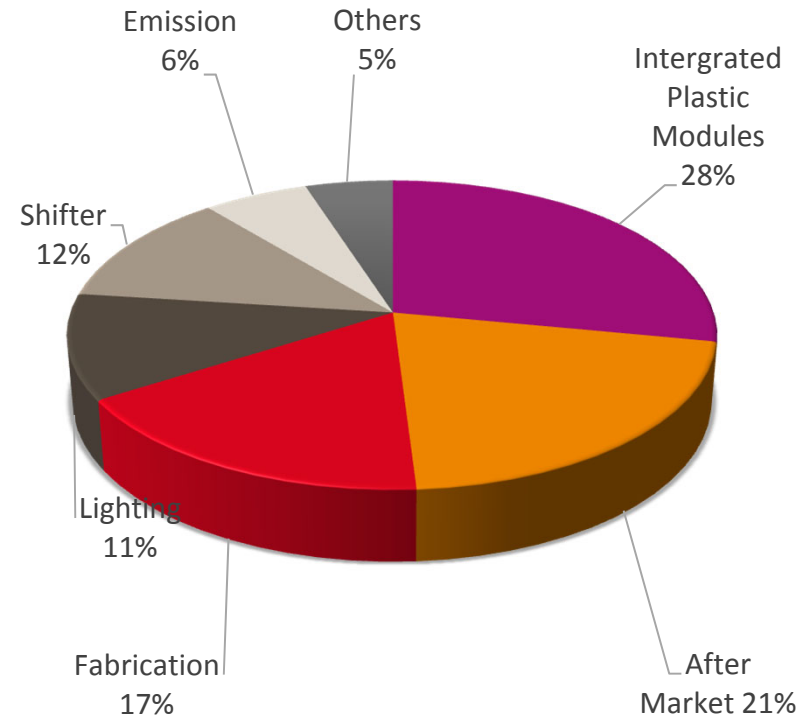

Product-wise Revenue H1FY22



Product-wise Revenue mix H1FY21 (Rs. 355 Crores)

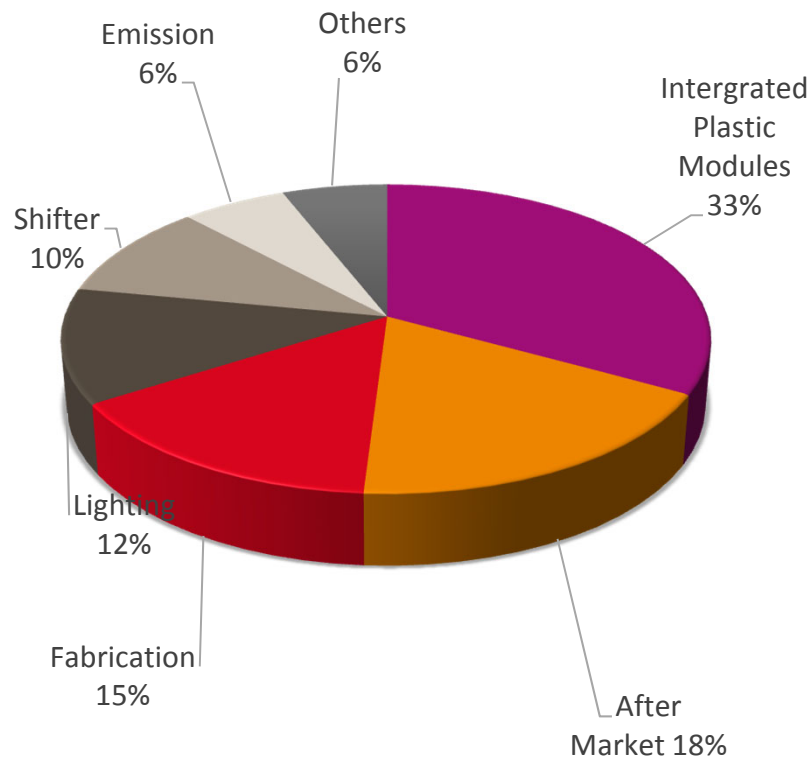

Product-wise Revenue mix H1FY22 (Rs. 663 Crores)

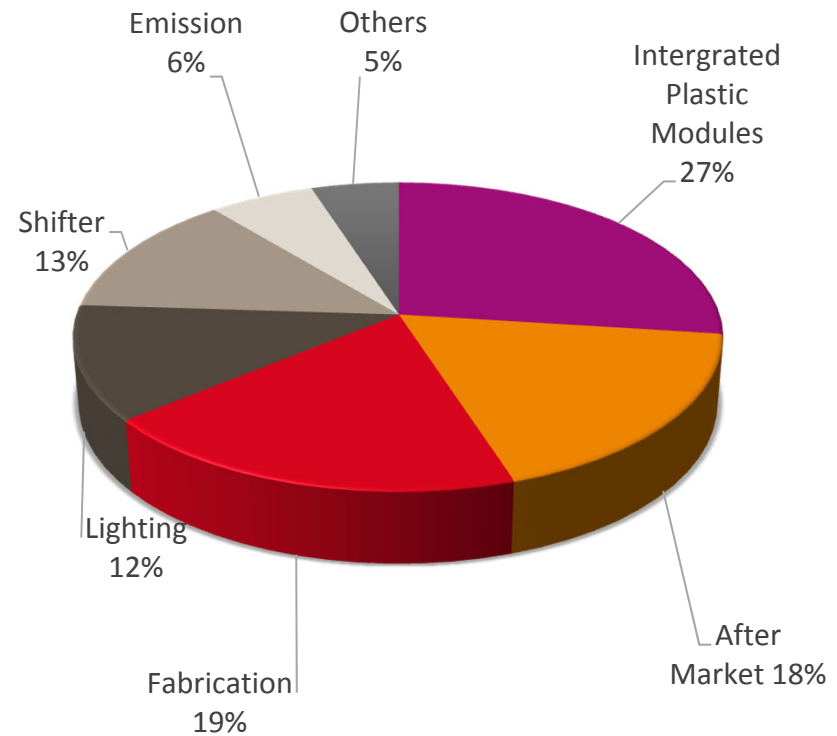

Segmental Revenue Break-Up Q2FY22: Category



Category Q2FY21
(Rs. 284 Crores)

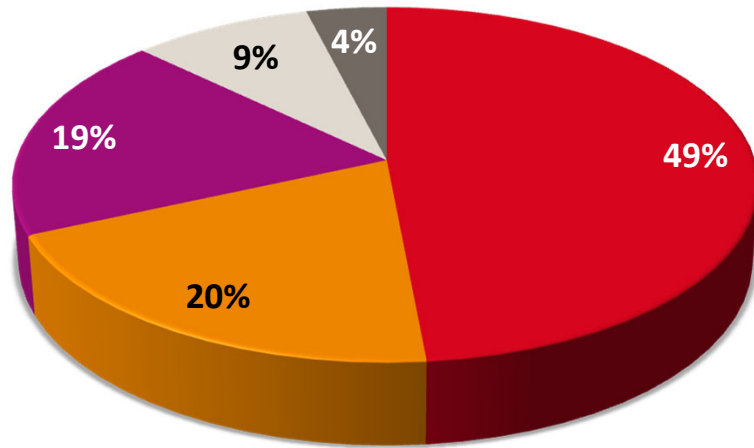

Category Q2FY22
(Rs. 403 Crores)

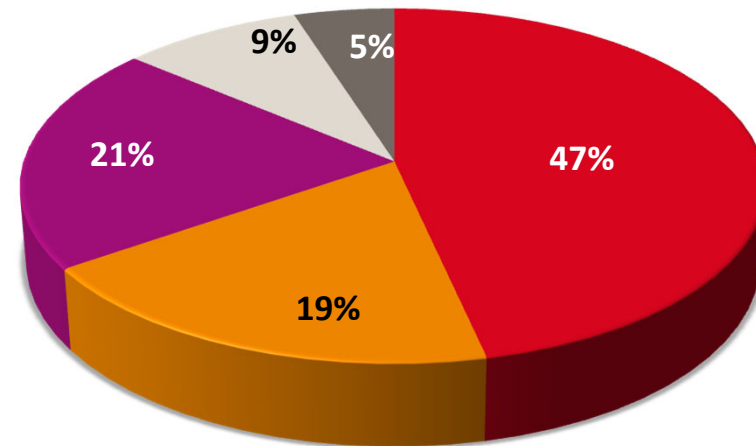

■ 2/3 Wheeler ■ Passenger Car ■ After Market ■ CV ■ Others

■ 2/3 Wheeler ■ Passenger Car ■ After Market ■ CV ■ Others

Segmental Revenue Break-Up H1FY22: Category



Category H1FY21
(Rs. 355 Crores)

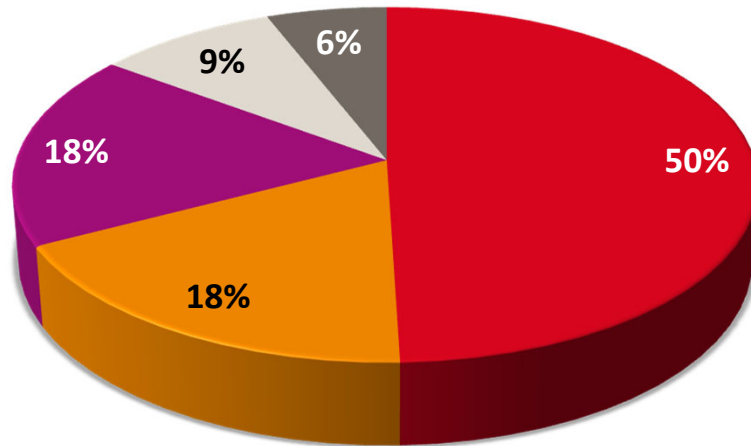

Category H1FY22
(Rs. 663 Crores)

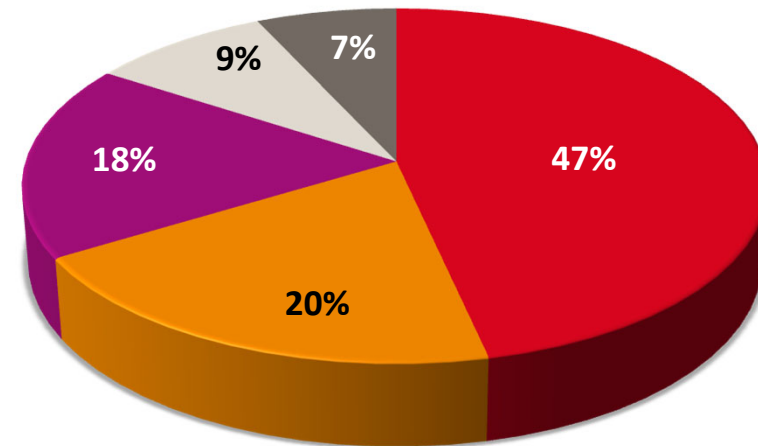

■ 2/3 Wheeler ■ Passenger Car ■ After Market ■ CV ■ Others

■ 2/3 Wheeler ■ Passenger Car ■ After Market ■ CV ■ Others

Customer wise – Revenue Q2FY22



Customer wise Q2FY21
(Rs. 284 Crores)

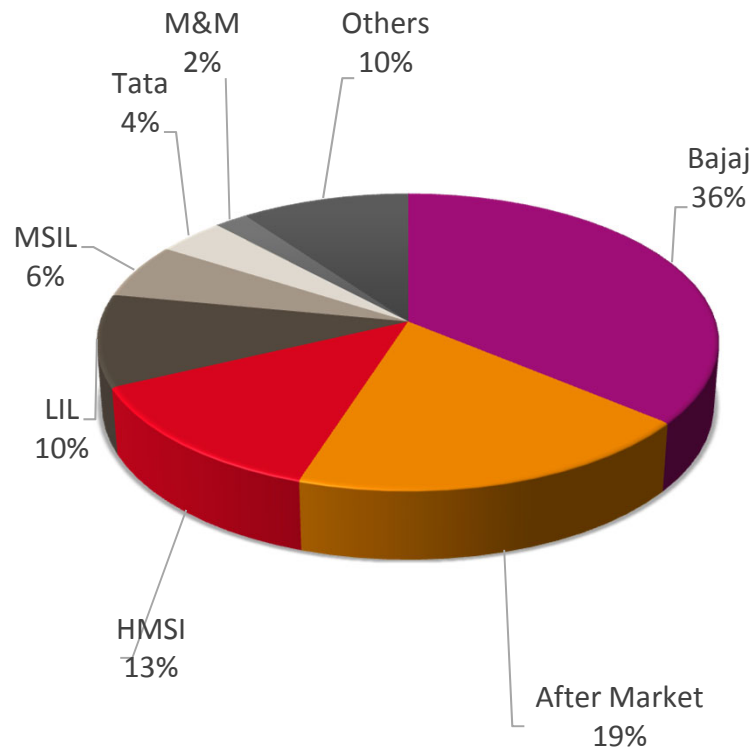

Customer wise Q2FY22
(Rs. 403 Crores)

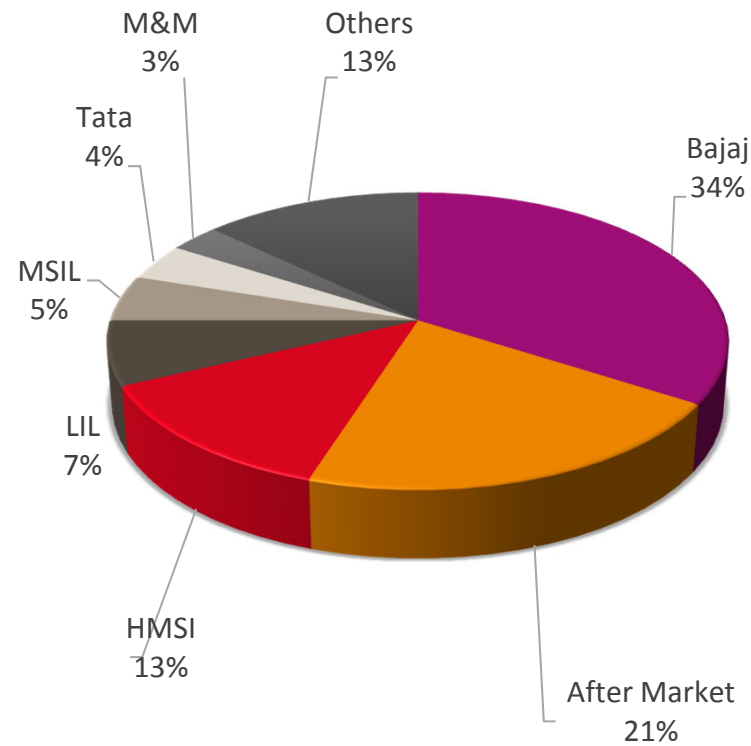

Customer wise – Revenue H1FY22



Customer wise H1FY21
(Rs. 355 Crores)

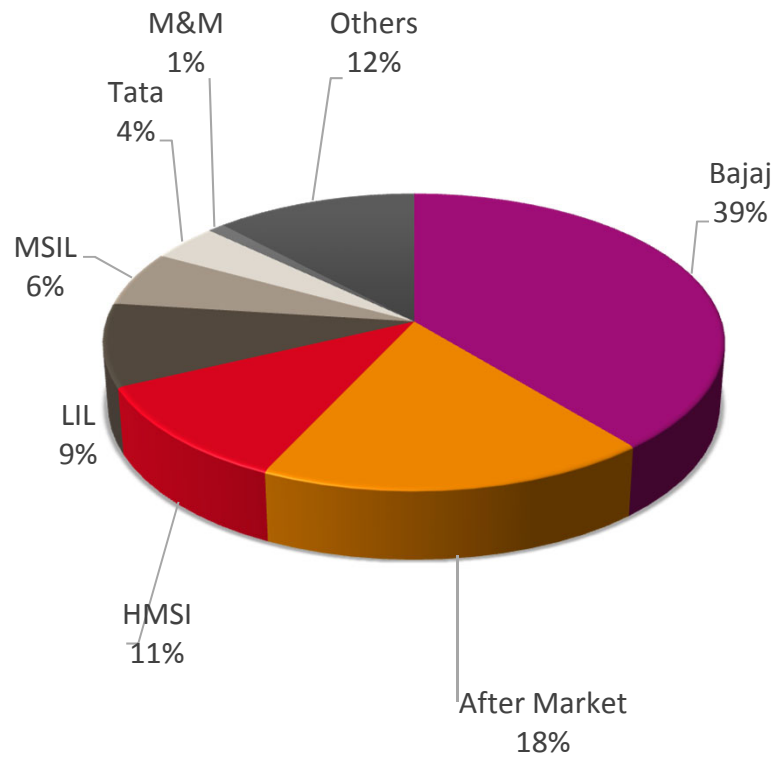

Customer wise H1 FY22
(Rs. 663 Crores)

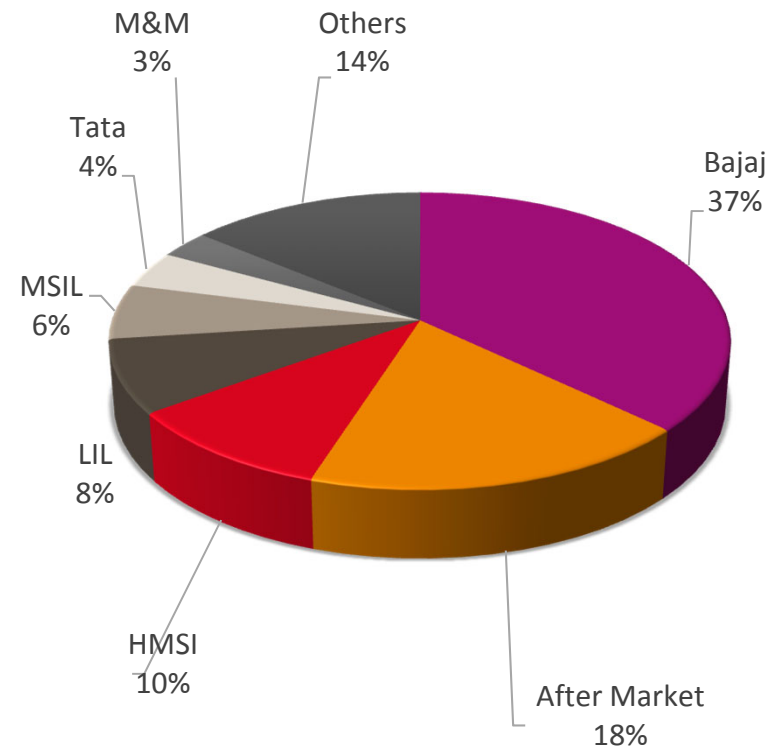

Strong historical financial performance



Revenue

Rs. Crores

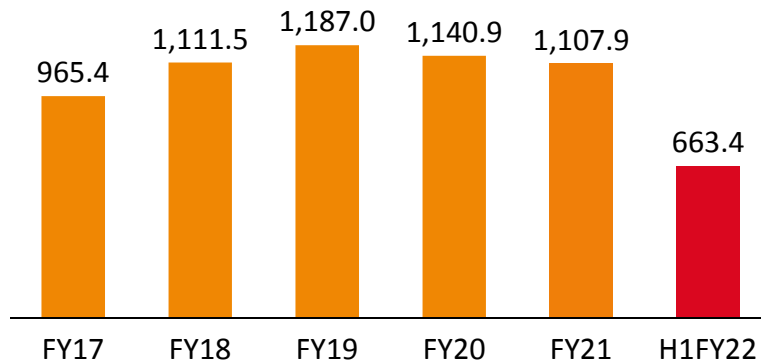

EBITDA[^]

Rs. Crores

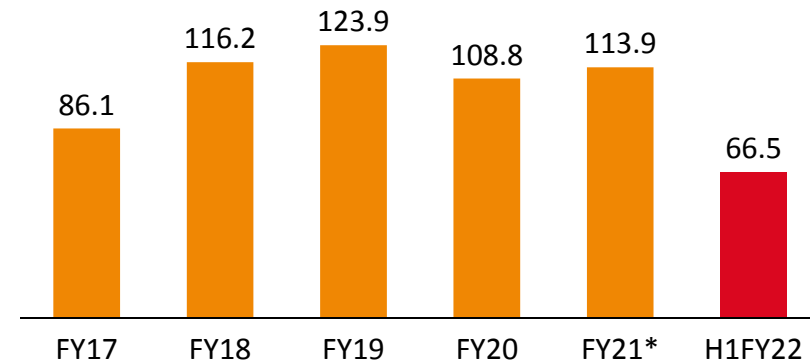

PAT After MI

Rs. Crores

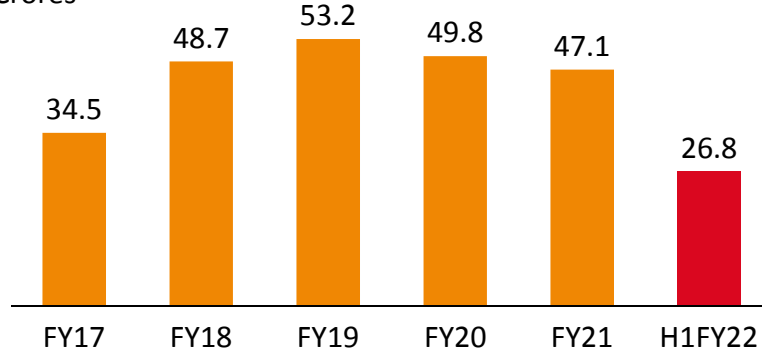

Cash PAT

Rs. Crores

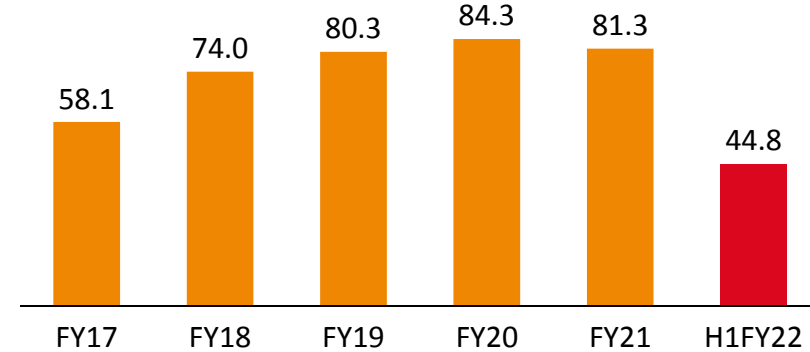

Consolidated

[^]EBITDA includes share of profits from JV's & other income

* FY21 EBITDA: Excluding gain on sale of property – Rs. 2.22 crores excluded from Other Income



Expansion funded through Internal Accruals



Gross Block

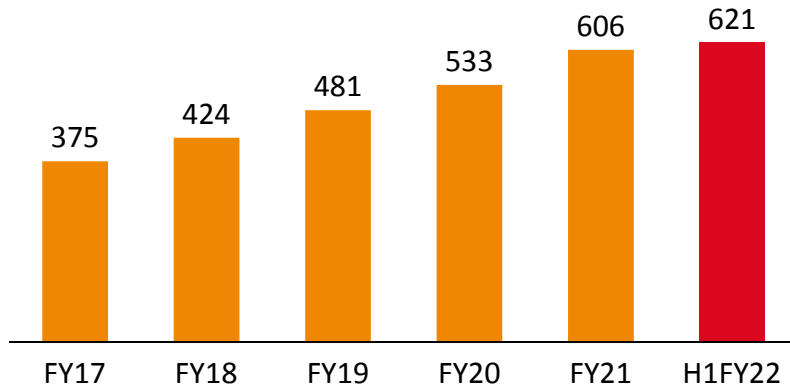

Long Term Loan

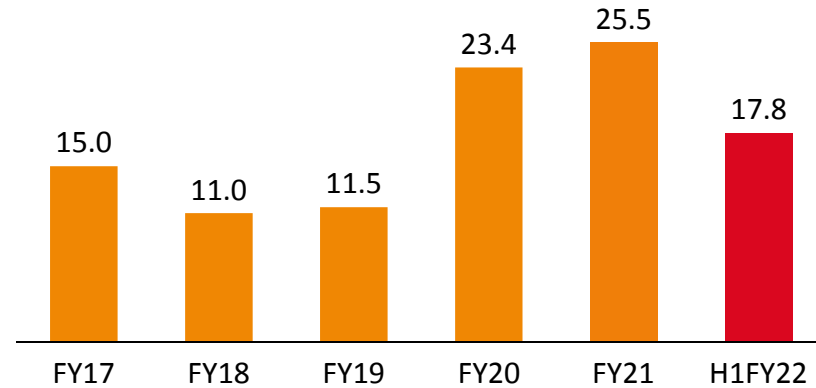

Capex

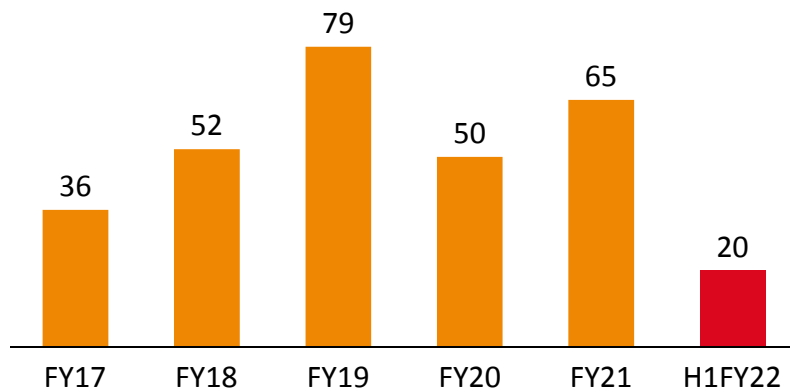

Long Term Debt / Equity

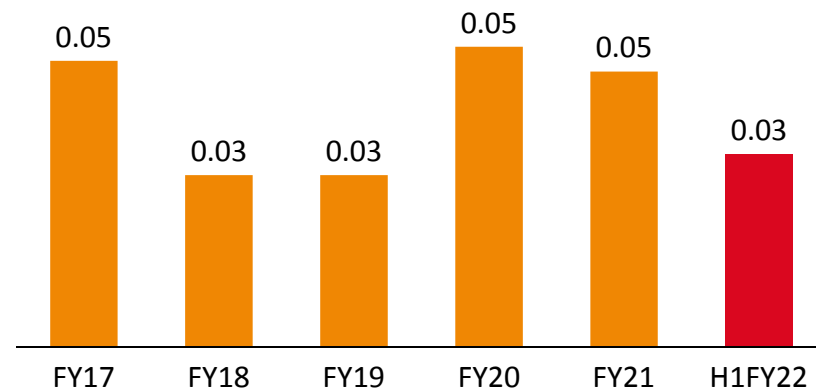

Consolidated
Rs. Crores



Return Ratios



ROE (%)

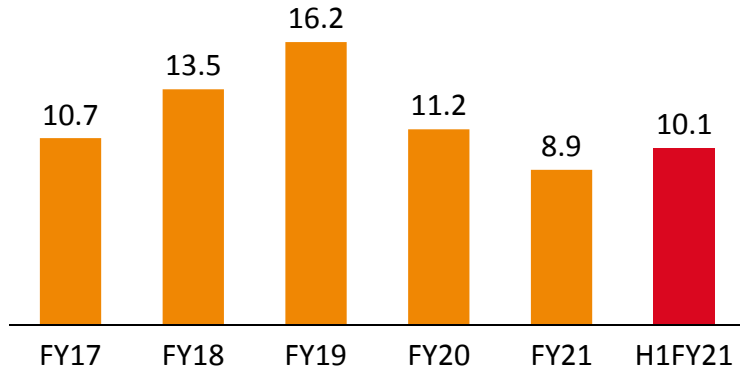

ROCE (%)

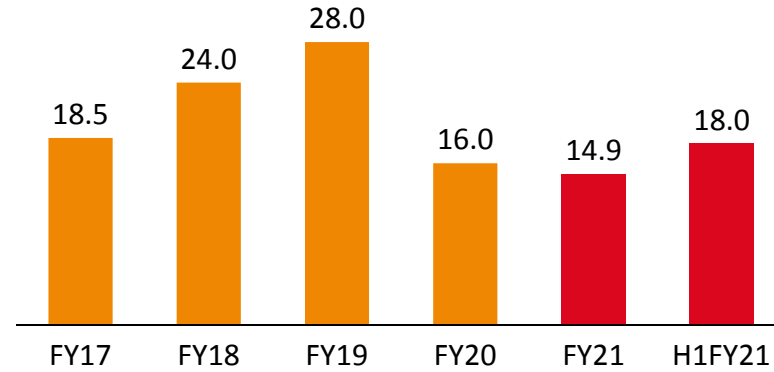

Dividend (% of Face Value)

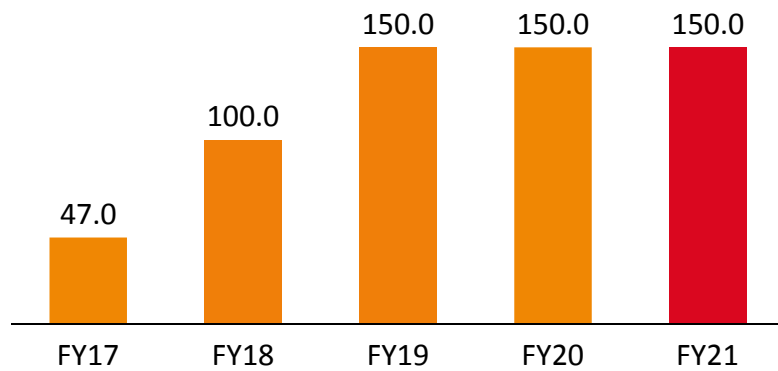

EPS^ (in Rs.)

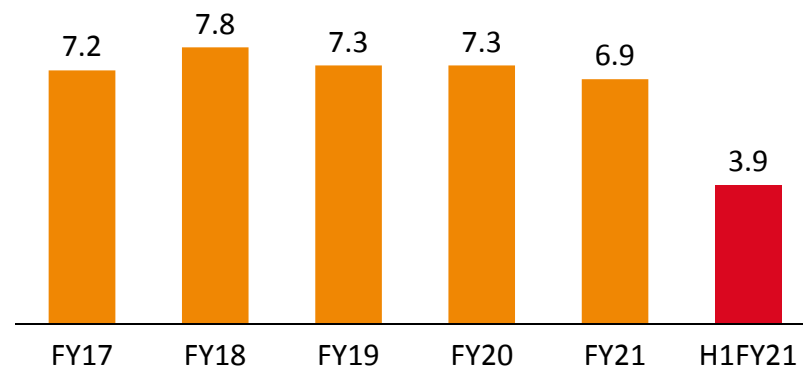

Consolidated

^ EPS on FV of Rs. 2 per share

ROCE = EBIT / Capital Employed

Capital Employed = Network + Long Term Debt including Current Maturity

Network = Shareholder's Equity – OCI Reserve



Consolidated P&L Statement



Particulars (Rs. in Crores.)	Q2 FY22	Q2 FY21	Y-o-Y	H1 FY22	H1 FY21	Y-o-Y
Revenue	403.0	283.8	42%	663.4	354.7	87%
Raw Material Consumption	273.4	190.5		449.4	238.5	
Employee Expenses	42.4	31.3		79.3	53.7	
Other Expenses	42.4	32.2		73.8	45.1	
Other Income	3.2	3.3		6.0	7.3	
Profit of JV	-0.1	0.04		-0.5	0.1	
EBITDA	47.8	33.2	44%	66.5	24.7	169%
EBITDA %	11.9%	11.7%		10.0%	7.0%	
Depreciation	9.4	8.1		18.0	15.9	
Finance Cost	2.1	2.5		4.4	5.6	
Profit Before Tax	36.3	22.6	60%	44.1	3.1	1300%
Tax	10.0	6.9		12.9	2.2	
Profit After Tax (Before Minority Interest)	26.3	15.7	67%	31.2	0.9	3347%
Minority Interest	2.9	0.4		4.4	-2.1	
Adjusted Profit After Tax	23.4	15.3	53%	26.8	3.0	784%
PAT Margin%	5.8%	5.4%		4.0%	0.9%	
EPS	3.43	2.25		3.93	0.44	

Consolidated Balance Sheet



ASSETS (Rs. in Crores.)	Sep-21	Mar-21
Non-current assets		
Property, plant and equipment	330.4	331.5
Capital work-in-progress	13.8	9.3
Investment Property	12.8	17.6
Right-to-use asset	36.2	28.1
Goodwill	0.2	0.2
Other Intangible assets	3.0	3.3
Investment in Jointly controlled Entities	1.6	1.0
Financial assets		
Investments	80.9	89.4
Loans	0.1	0.1
Others	6.9	6.1
Income Tax Assets	6.9	6.8
Other non-current assets	16.6	9.3
Deferred Tax Assets (net)	0.01	0.1
Sub-total - Non-Current Assets	509.5	502.9
Current assets		
Inventories	99.2	83.6
Financial assets		
Loans	0.6	0.6
Investments	41.0	40.3
Trade receivables	250.7	223.0
Cash and cash equivalents	31.5	16.7
Bank balances other than Cash	90.1	81.3
Other Financial Assets	7.5	12.7
Other current assets	40.5	28.6
Assets held for Sale	-	-
Sub-total - Current Assets	561.2	486.7
TOTAL - ASSETS	1070.7	989.7

EQUITY & LIABILITIES	Sep-21	Mar-21
Equity		
Equity Share capital	13.6	13.6
Non Controlling Interest	43.4	40.4
Other equity	514.7	517.1
Sub-total - Shareholders' funds	571.7	571.1
LIABILITIES		
Non-current liabilities		
Financial liabilities		
Borrowings	11.7	5.5
Lease Liability	28.1	18.7
Provisions	6.6	6.3
Deferred tax liabilities (net)	13.0	14.1
Sub-total - Non-current liabilities	59.4	44.6
Current liabilities		
Financial liabilities		
Borrowings	95.7	66.9
Lease Liability	6.1	7.3
Trade payables	218.9	204.8
Other financial liabilities	33.1	32.6
Provisions	18.1	15.4
Other current liabilities	63.6	44.4
Current tax liabilities	4.1	2.7
Sub-total - Current liabilities	439.5	374.0
TOTAL - EQUITY AND LIABILITIES	1070.7	989.7

Consolidated Cash Flow Statement



Particulars (Rs in Cr)	H1FY22	H1FY21
Profit before tax from continuing operations	44.1	3.1
Adjustments	18.8	14.3
Operating profit before working capital changes	62.9	17.5
Changes in working capital	-17.7	49.9
Cash generated from operations	45.2	67.4
Direct taxes paid (net of refund)	-12.5	-4.1
Net Cash from Operating Activities	32.7	63.3
Net Cash from Investing Activities	-23.5	-44.2
Net Cash from Financing Activities	5.7	-48.2
Net Change in cash and cash equivalents	14.9	-29.1
Opening Cash Balance	16.7	37.0
Closing Cash Balance	31.5	7.8



Awards & Recognitions



Awards & Recognition



Congratulations!

Dear All,

On achieving the significant milestone, we sincerely congratulate to the team. It's a proud moment for all of us that, our team "LATL B-14 Aurangabad & LATL G 53 Aurangabad" won the "Gold Award" in the category of **Quality Circle** for "54th Mini Convention 2021" Competition which was held in July this year.

We are all very proud and thankful to our team

Team	Team Member	Award	Team	Team Member	Award
Umeed (B14)	Ashok Pawar	Gold Award	Vikrant (G53)	Kapesh Badgajar	Gold Award
	Sarita Agrawal			Balaji Chavan	
	Shradha Susle			Sunil Mishra Sarala Wagh Arshana Donde	

We wish best of luck for all your future endeavors

Thank You,
HR Department.

Aurangabad plant won the Gold Award in the category of Quality Circle at the 54th Mini Convention 2021 organised by QCFI in July 2021.

Congratulations!

Dear All,

It's with immense pleasure I would like to inform you all that, it's a proud moment for all of us that, our team from **Lumax Auto Technologies Limited Chinchwad** won the "Gold Award" in the Category of **Quality Circle** for **54th Mini Convention 2021 Competition** which was held in July this year.

We are all very proud and thankful to our team.

Team	Team Member	Award
Venus	Yogesh Gorde	Gold Award
	Rohit Wani	
	Shivam Pol	
	Amit Gore	
	Priyam Pandey	
	Rajendra Tagad	
Amit Kamble		

We wish best of luck for all your future endeavors.

Chinchwad plant won the Gold Award in the category of Quality Circle at the 54th Mini Convention 2021 organised by QCFI in July 2021.

Best Awards under Productivity

1st Position
Zwal - Roli Minda Co. Pvt. Ltd., Ahmedabad

2nd Position
Mission - Lumax Auto Technologies Ltd. - B14, Waluj

3rd Position
Qualicox - Yazaki India Pvt. Ltd., Wagholi

Aurangabad plant bagged the 2nd Position under Productivity Category at the 16th Quality Circle Competition (Virtual) organised by ACMA Western Region in July 2021.



Awards & Recognition



Aurangabad plant won the Silver Recognition Award in the category - Manufacturing Sector Tier I - Productivity Improvement for the Project - Output / Man improvement in Swing Arm pipe through low cost automation at the 5th CII National Competition on Low Cost Automation held in February 2021.



Lumax Mettalics Private Limited, Pune won the Gold Award in the category Excellence in HSE – Small at the ACMA Excellence Awards 2020 in February 2021.



Bengaluru plant won JIPM-TPM award for excellence in Category A for the year 2019

Awards & Recognition



Toyota Kirloskar Motor Pvt Ltd. recognised the efforts and commitment of Lumax Mannoh Allied Technologies Limited towards providing timely and quality delivery to Toyota in 2020.



Pantnagar plant won the Silver Award in Excellence in HSE (Health, Safety and Environment) - Very Large Category at ACMA Technology Summit & Awards in November, 2019.



Lumax Mannoh Allied Technologies Limited, Manesar won the Bronze Award in Excellence in HR at the ACMA Technology Summit & Awards in November, 2019.

Awards & Recognition



Lumax Mannoh Allied Technologies Limited, Manesar bagged Silver Award at ICQCC 2019 held at Tokyo, Japan in September, 2019. A total of 368 teams from 13 countries participated in the global Quality Control Circles competition.



Lumax Mannoh Allied Technologies Limited awarded for Improvement in Quality Performance by Maruti Suzuki India Limited in May, 2019



Lumax Cornaglia Auto Technologies Pvt. Ltd. was awarded the Silver Award in Manufacturing Excellence (Medium Category) and Lumax Auto Technologies Limited, Pantnagar was awarded the Silver Award in Manufacturing Excellence (Large Category) by ACMA in 2019

Awards & Recognition



Lumax Mettolics Pvt Ltd won the Gold Award in Excellence in HSE (Health, Safety & Environment) - Small Category at the ACMA Technology Summit & Awards in November, 2019.



Chakan Plant, Received JIPM Award for TPM Excellence, Category B on 23rd March 2017

Awards & Recognition



Won the prestigious Gold award for Top 100 best annual report from League of American Communications Professionals (LACP) for excellence within its industry for the financial year 2018-19



Won the prestigious Platinum award for best annual report from League of American Communications Professionals (LACP) for excellence within its industry for the financial year 2019-20



Awards & Recognition

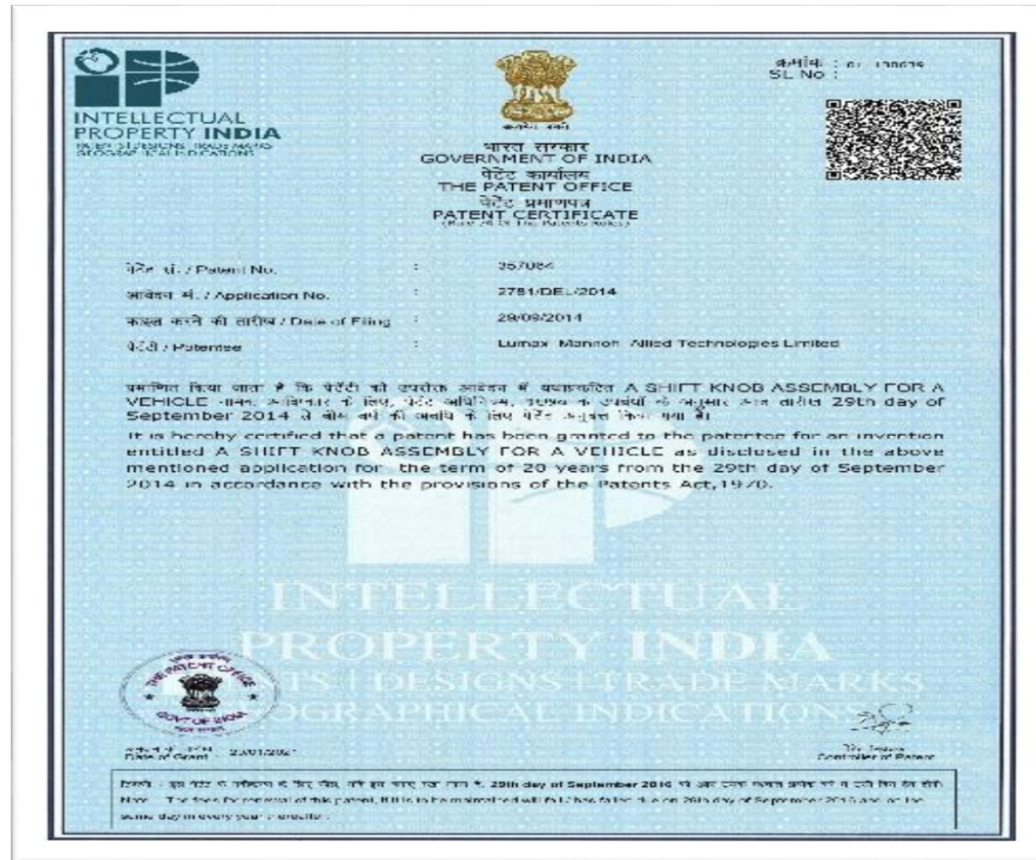

Lumax Mannoh Allied Technologies Ltd. received first ever Patent registration from the Government of India for invention in “Shift Knob Assembly” in January 21

State-of-the-Art Manufacturing Facilities



State-of-the-Art Manufacturing Facilities



CSR Initiatives



Education

Towards its endeavour to give back to society, the group has taken various initiatives towards Education of the underprivileged. Four schools in the NCR region, close to its facilities have been adopted, starting with improving its infrastructure, to facilitating the annual fee so as to ensure a conducive environment for learning and continuity in education.

Also provide support towards maintaining good health of the community around its facilities

Health



For further information, please contact:

Company:

Investor Relations Advisors:



Lumax Auto Technologies Limited
CIN: L31909DL1981PLC349793

Ms. Priyanka Sharma
priyanka.sharma@lumaxmail.com

www.lumaxworld.in/lumaxautotech



Strategic Growth Advisors Pvt. Limited
CIN: U74140MH2010PTC204285

Mr. Shogun Jain / Ms. Akashi Modi
shogun.jain@sgapl.net / akashi.modi@sgapl.net

Tel: +91 77383 77756 / +91 96198 96128
www.sgapl.net