

Registered Office
"Maithri"
132, Cathedral Road,
Chennai 600 086, India.
CIN: L65993TN2004PLC052856

Tel: 91 44 2811 2472
URL: www.ranegroup.com

Rane (Madras) Limited



// Online submission //

RML / SE / 033/ 2023-24

August 07, 2023

BSE Limited Listing Centre Scrip Code: 532661	National Stock Exchange of India Ltd. NEAPS Symbol: RML
--	--

Dear Sir / Madam,

Sub: Earnings Presentation – Quarterly Unaudited Financial Results for the quarter ended June 30, 2023

We enclose herewith copy of the Earnings presentation released on the quarterly Unaudited Financial Results for the quarter ended June 30, 2023.

The same is also being made available on the website of the Company, www.ranegroup.com.

We request you to take the above on record and note the compliance with SEBI (Listing Obligations and Disclosure Requirements) Regulations, 2015 (SEBI LODR).

Thanking you,

Yours faithfully,

For **Rane (Madras) Limited**

S Subha Shree
Secretary

Encl: a/a

Rane Group

Earnings Presentation | Q1 FY24

Table of Contents



Q1 FY24 Financial & Operational Performance

Rane Group Overview



Rane Group

Q1 FY24 Financial & Operational Performance



To become the Preferred Trusted Supplier of Safety & Critical Auto Components

Strategic pillars of growth

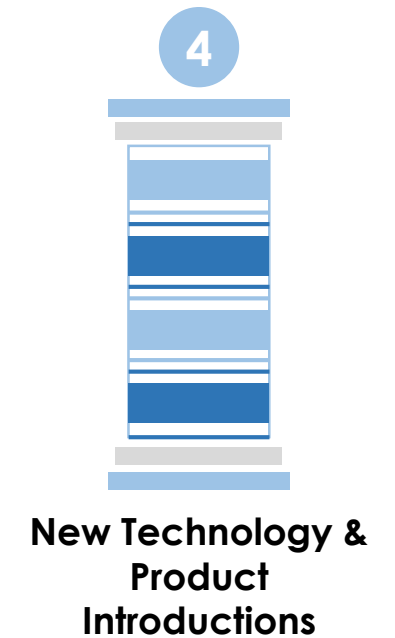
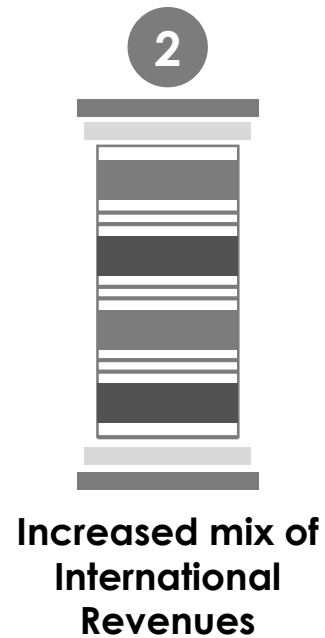

Business Drivers

- › **92%+ of revenue comes from powertrain agnostic products**
- › **Continued dominance on domestic market across major products**
- › **Increasing export mix for steering & linkages, valve train components and occupant safety products**
- › **Renewed focus on Aftermarket segment leveraging group level synergy**
- › **Continuous new product introductions leveraging strong in-house engineering capabilities**
- › **Increasing efficiencies across manufacturing facilities through operational excellence and digitalization.**

RANE BRAKE LINING

- Won orders worth Rs. 8 Cr from various customers including a trial order to the US market

RANE (MADRAS)

- Won Rs. 90 Cr order for ball joint products from an international customer
- Won Rs. 40 Cr order for Rack housing for PV segment in domestic market
- Won Rs. 18 Cr order for Rack and Pinion products from domestic customer

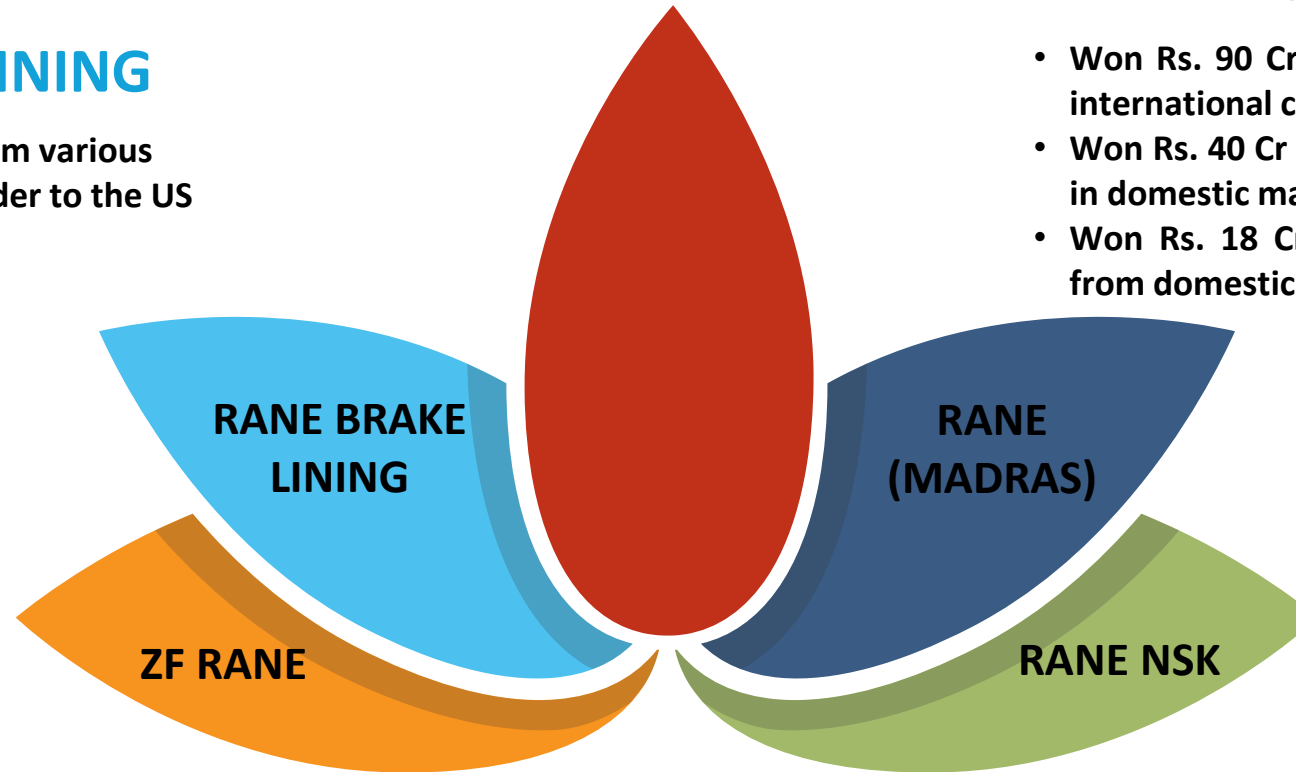

ZF RANE





- Won export order worth Rs. 45 Cr for Hydraulic Pump
- Won order worth Rs. 10 Cr for Occupant Safety Product from domestic PV customer

RANE NSK

- Won new business worth Rs. 120 Cr for EPS from domestic customer

During the quarter new business of Rs. 148 Cr won for EV platforms

We continue to target higher than the industry growth

Industry Performance Review (Q1 FY24)	 Passenger Vehicle	 commercial Vehicle	 Farm Tractor	 2-Wheeler
Production YoY Growth# in %	7%	-1%	-7%	1%
Rane Group Sales Growth YoY in % (India OEM)	6%	6%	-11%	13%
Rane Group Revenue Split * (India OEM)	60%	28%	6%	3%
	<ul style="list-style-type: none"> Lower growth than the industry due to lower growth on served models in Passenger Cars. 	<ul style="list-style-type: none"> Higher share of business and higher growth with served models/customers 	<ul style="list-style-type: none"> Performance is lower than industry due to de-growth in served models 	<ul style="list-style-type: none"> Better performance is driven by higher sales of friction material products

* Other segments such as Rail, Defence, Stationary Engines and 3-Wheeler contribute around 3%

Market Commentary

- Strong demand Indian PV customers driven by new model launches
- There was growth in M&HCV and LCV segment despite pre-buy (in March 2023) ahead of BS 6 Phase 2
- The de-growth in Farm Tractor segment is mainly due to higher base of 1Q FY23
- Demand from international markets remained favourable across product categories

Group Aggregate Sales (Q1 FY24)

Group Aggregate Sales (Rs cr.)

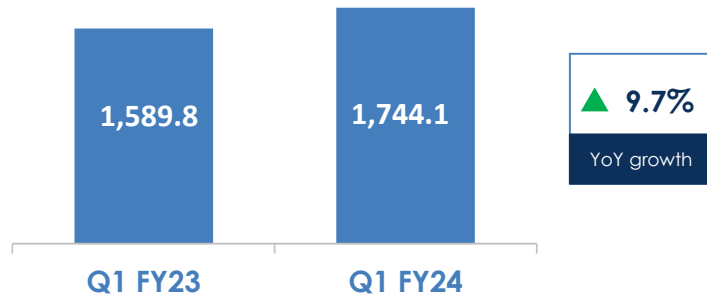

- › Sales increased by 9.7% from Rs. 1,589.8 Cr in Q1 FY23 to Rs. 1,744.1 Cr in Q1 FY24
- Revenue from Indian OE customers grew 5% supported by strong growth across vehicle segments
- Revenues from International customers increased 29% driven by higher off-take across steering, valve train, light metal casting and occupant safety products
- Revenue from Indian aftermarket segment decreased by 2%

Group Aggregate Sales (Q1 FY24)

BY PRODUCT (%)

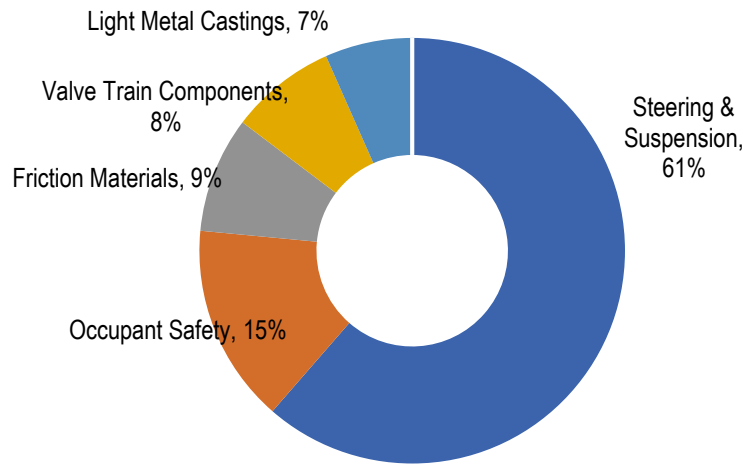

BY MARKET (%)

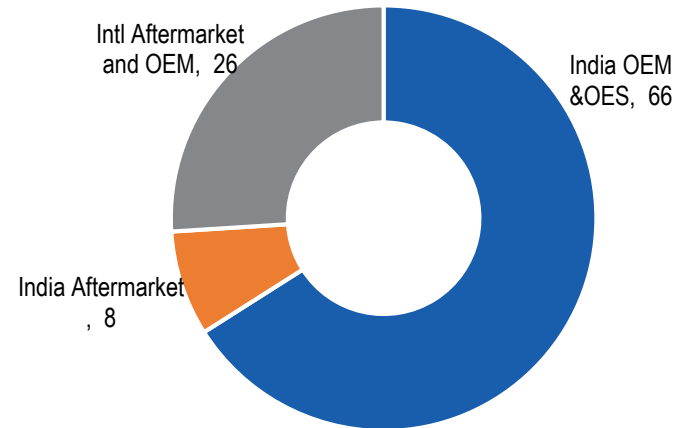

BY VEHICLE SEGMENT (%)

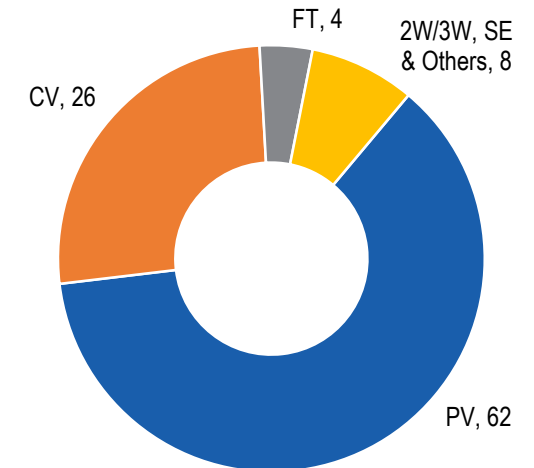

Total Revenue (Rs cr.)



EBITDA (Rs cr.)



Adjusted PAT* (Rs cr.)



PAT* (Rs cr.)



› Total Revenue increased by 9.3% from Rs. 821.1 Cr in Q1 FY23 to Rs. 897.7 Cr in Q1 FY24

› EBITDA increased by 39.5% from Rs. 58.0 Cr in Q1 FY23 to Rs. 80.9 Cr in Q1 FY24

— EBITDA margin increased 195 bps supported by lower material cost and improved operational performance.

› PAT decreased by 41.3% from Rs.20.6 Cr in Q1 FY23 to Rs. 12.1 Cr in Q1 FY24

— Exceptional expenses of Rs. 19.9 Cr in Q1 FY'24 (Rs. 1.1 Cr in Q1 FY'23) towards warranty provision and VRS.

Rane (Madras) Limited

Q1 FY24 Financial & Operational Performance

Business Drivers

- › Strong order book pipeline for Steering and Linkages products
- › Light Metal Castings India business working on operational improvements and launching a major new program for export customer to SOP in the upcoming quarter

Operational Highlights

- › Great Place to Work (GPTW) certified for six consecutive times
- › Achieved highest production in SSLP (Linkages, Ball joints) and in Export ball joints for a month
- › Light Metal Castings Business won Certificate of Appreciation from Toyota Industries Engine India Private Limited (TIEI) in recognition of outstanding contribution by achieving Zero Defect Supplies for the year 2022

Business Split (Q1 FY24) – RML India

BY MARKET (%)

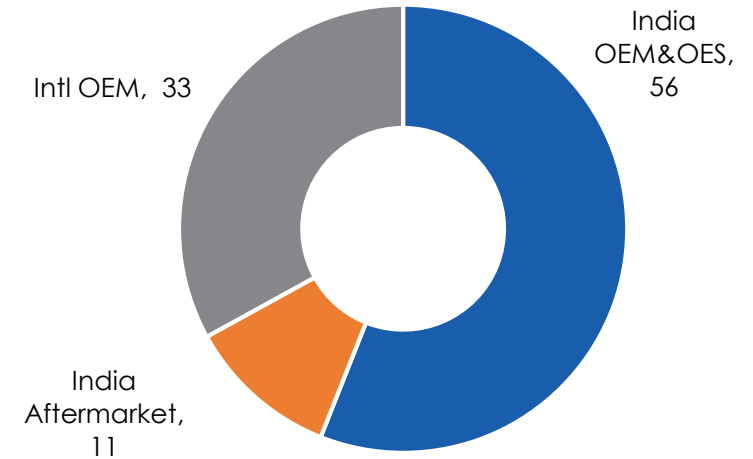

BY VEHICLE SEGMENT (%)

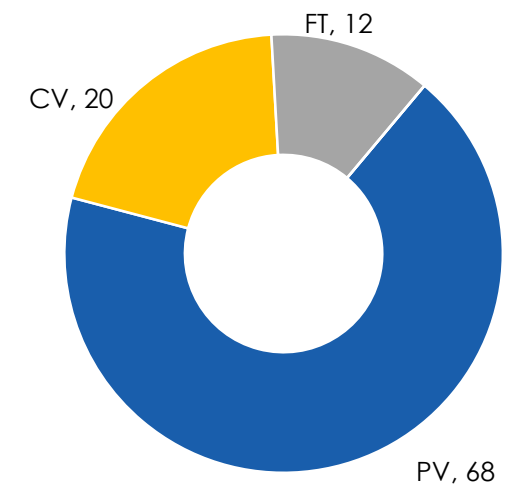

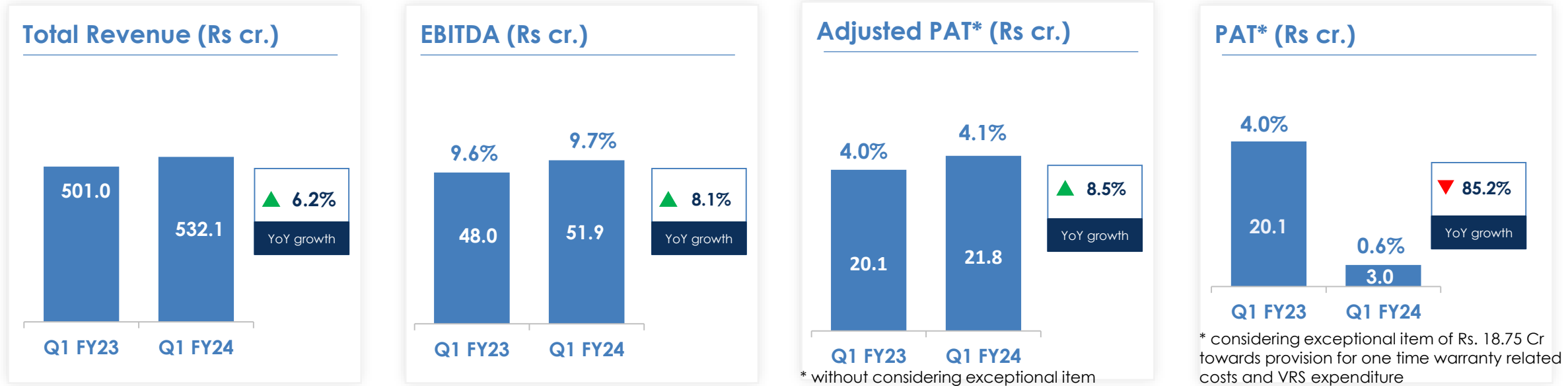

› **Total Revenue increased by 6.2% from Rs. 501.0 Cr in Q1 FY23 to Rs. 532.1 Cr in Q1 FY24**

- Sales to Indian OE customers dropped 1% due to decline in Farm Tractors segment and served segment de-growth in M&HCV
- Sales to International customers grew 33% driven by strong off-take for steering and light metal casting products.
- Sales to Indian Aftermarket customers declined by 17%.

› **EBITDA increased by 8.1% from Rs. 48.0 Cr in Q1 FY23 to Rs. 51.9 Cr in Q1 FY24**

- EBITDA margin increased by 17 bps supported by favourable material price movement and which is offset by inflationary pressure on employee and other costs.

› **PAT decreased by 85.2% from Rs. 20.1 Cr in Q1 FY23 to Rs. 3.0 Cr in Q1 FY24**

- Exceptional expenses of Rs. 18.75 Cr in Q1 FY'24 (Nil in Q1 FY'23) towards provision for one time warranty related costs and VRS

Total Revenue (Rs cr.)



EBITDA (Rs cr.)

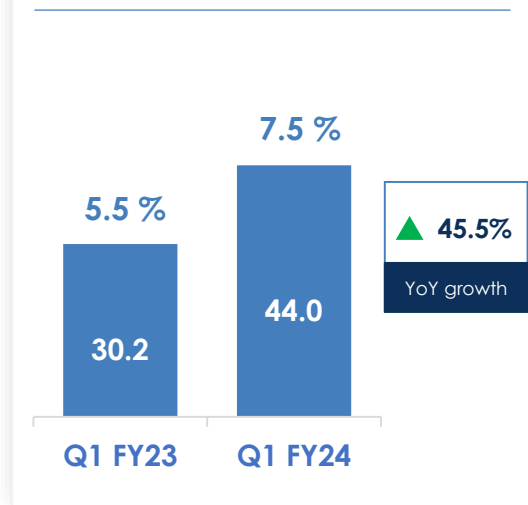

PAT (Rs cr.)

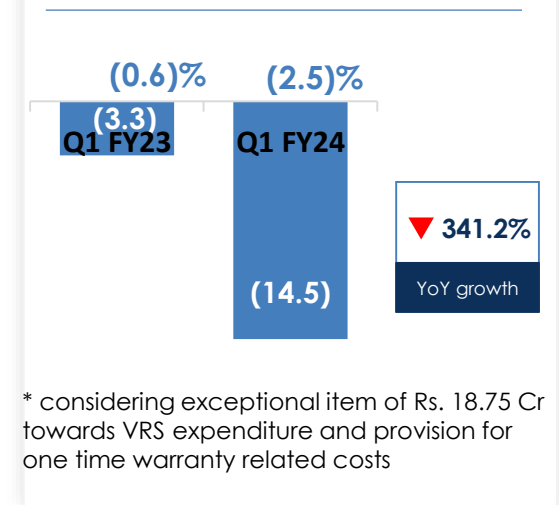

- › Total Revenue increased by 7.2% from Rs. 550.4 Cr in Q1 FY23 to Rs. 590.0 Cr in Q1 FY24
 - › EBITDA increased by 45.5% from Rs. 30.2 Cr in Q1 FY23 to Rs. 44.0 Cr in Q1 FY24
 - › Loss increased from Rs. 3.3 Cr in Q1 FY23 to loss of Rs. 14.5 Cr in Q1 FY24
- Exceptional expenses of Rs. 18.75 Cr in Q1 FY'24 (Nil in Q1 FY'23) towards provision for one time warranty related costs and VRS

The Company has decided to divest its wholly owned subsidiary Rane Light Metal Casting Inc., USA (LMCA)



Rane Engine Valve Limited

Q1 FY24 Financial & Operational Performance



Business Drivers

- › 43% of revenue generated from EV insulated segment
- › Sustaining financial turnaround through
 - › Higher capacity realization and new business ramp up
 - › Increasing mix of exports and EV insulated segment
 - › Operational performance improvement

Operational Highlights

- › All plants showed improvement in their delivery performance, resulting in the highest sales achieved during the quarter.
- › Great Place to Work (GPTW) certified for 3rd time in four years

Business Split (Q1 FY24)

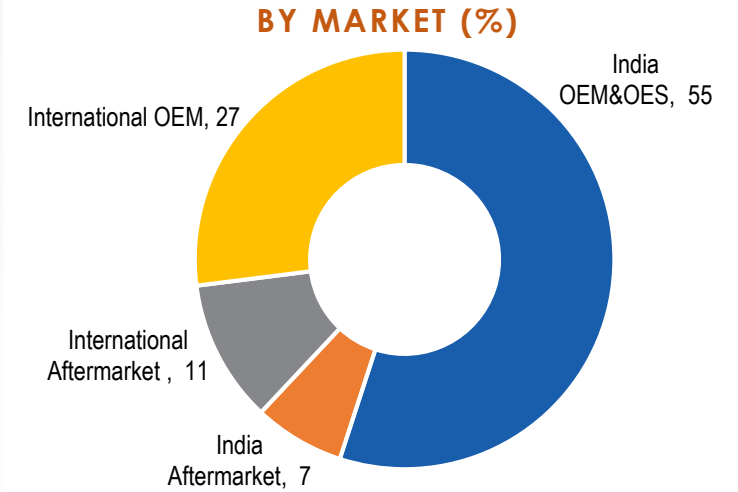

BY VEHICLE SEGMENT (%)

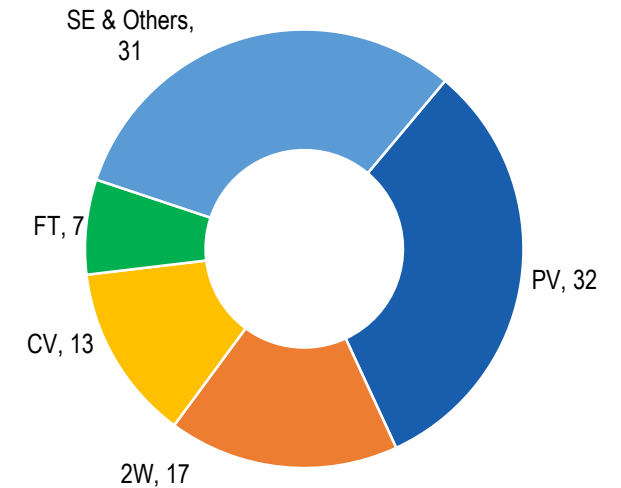

Total Revenue (Rs cr.)

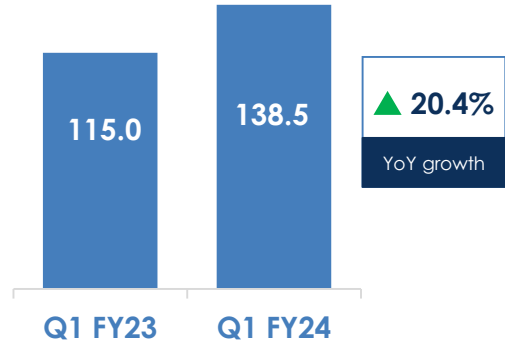

EBITDA (Rs cr.)

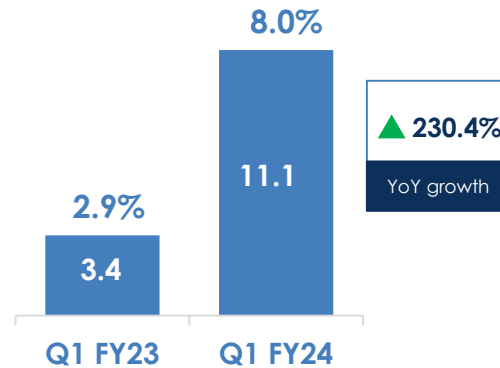

PAT (Rs cr.)

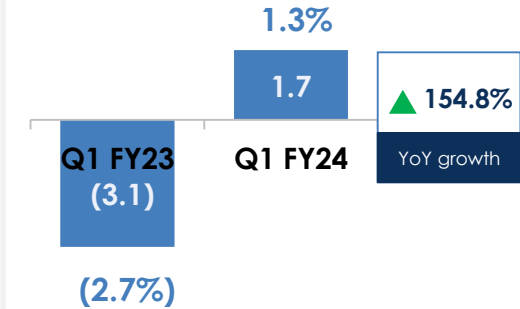

› **Total Revenue increased by 20.4 % from Rs. 115.0 Cr in Q1 FY23 to Rs. 138.5 Cr in Q1 FY24**

- Sales to Indian OE customers grew by 19% supported by strong offtake from Passenger vehicles and commercial vehicles customers.
- Export Sales grew 25%. Demand from International customers remained strong.
- Sales to Indian Aftermarket customers grew by 10%.

› **EBITDA increased by 230.4% from Rs. 3.4 Cr in Q1 FY23 to Rs. 11.1 Cr in Q1 FY24**

- Higher volumes and improvement in operational performance helped improve EBITDA margin by 511 bps

› **PAT increased from a Loss of Rs. 3.1 Cr in Q1 FY23 to a profit of Rs. 1.7 Cr in Q1 FY24**

- Exceptional expenses of Rs. 1.13 Cr in Q1 FY'24 (Rs.1.05 Cr in Q1 FY'23) towards Warranty provision



Rane Brake Lining Limited

Q1 FY24 Financial & Operational Performance



Business Drivers

- › Market leader in Passenger Vehicle segment and increased penetration in two wheeler segment
- › Strong growth in Aftermarket segment
- › Continued traction in International Aftermarket segment

Operational Highlights

- › Great Place to Work (GPTW) certified for seventh consecutive time
- › Received “Best Performance Supplier Award overall and Best Supplier Friction Category” from Brakes India Pvt Ltd.
- › RBL Trichy Plant won Second Prize for “Environment Protection and Management” from the Government of Tamil Nadu

Business Split (Q1 FY24)

BY MARKET (%)

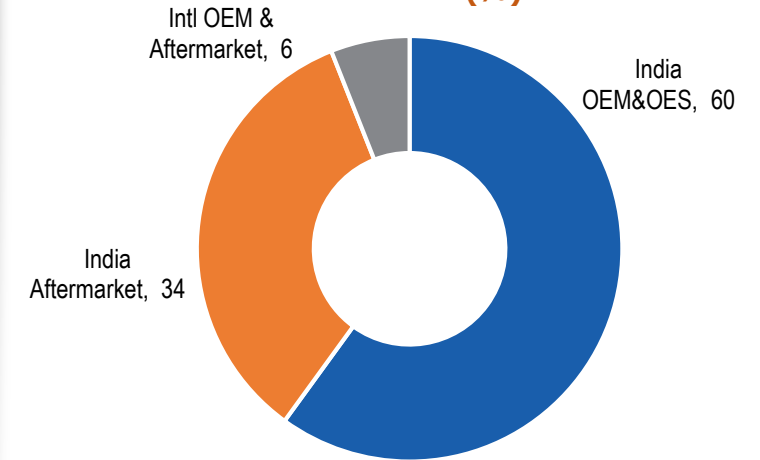

BY VEHICLE SEGMENT (%)

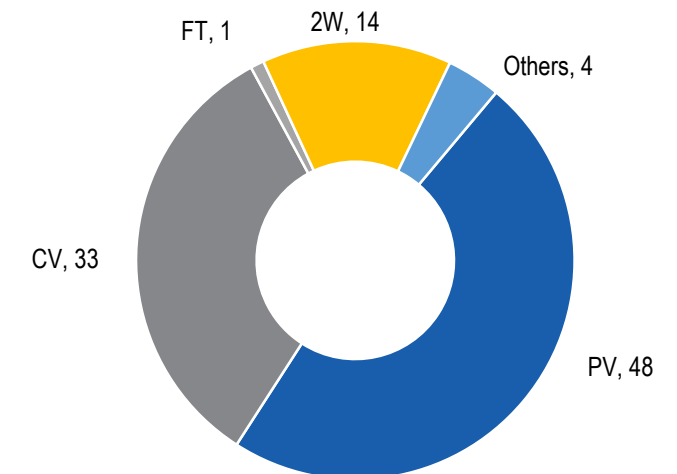

Total Revenue (Rs cr.)



EBITDA (Rs cr.)

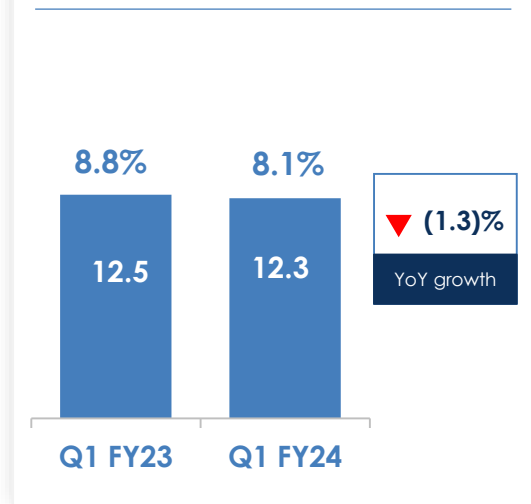

PAT (Rs cr.)

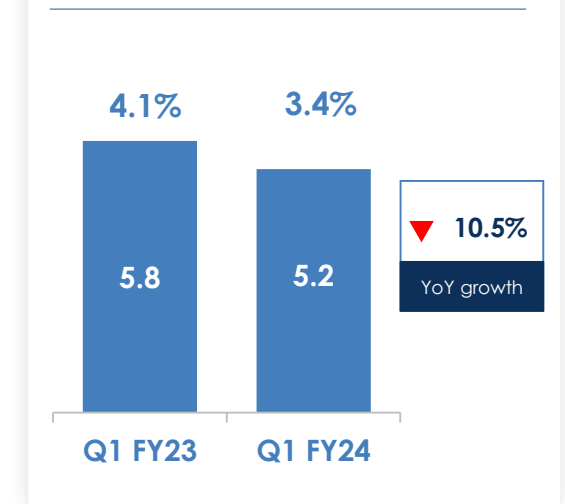

› **Total Revenue increased by 7.9% from Rs. 141.9 Cr in Q1 FY23 to Rs. 153.1 Cr in Q1 FY24**

- Sales to OE customer grew 8%, which was driven by strong sales to Two wheeler segment.
- Sales to Aftermarket customers grew 10%

› **EBITDA decreased by 1.3% from Rs. 12.5 Cr in Q1 FY23 to Rs. 12.3 Cr in Q1 FY24**

- EBITDA margin decreased by 75 bps due to unfavourable forex and increase in employee expenses.

› **PAT decreased by 10.5% from Rs. 5.8 Cr in Q1 FY23 to Rs. 5.2 Cr in Q1 FY24**



ZF Rane Automotive India Private Limited

Q1 FY24 Financial & Operational Performance



Business Drivers

- › Market upcycle in commercial vehicle segment aids growth in steering division
- › Occupant safety division benefits from evolving safety regulation in India
- › Continue to enhance Exports

Operational Highlights

- › Started mass production for Webbing from new plant in Chennai
- › Achieved highest sales for the quarter
- › Great Place to Work (GPTW) certified for 3rd time in four years

Business Split (Q1 FY24)

BY MARKET (%)

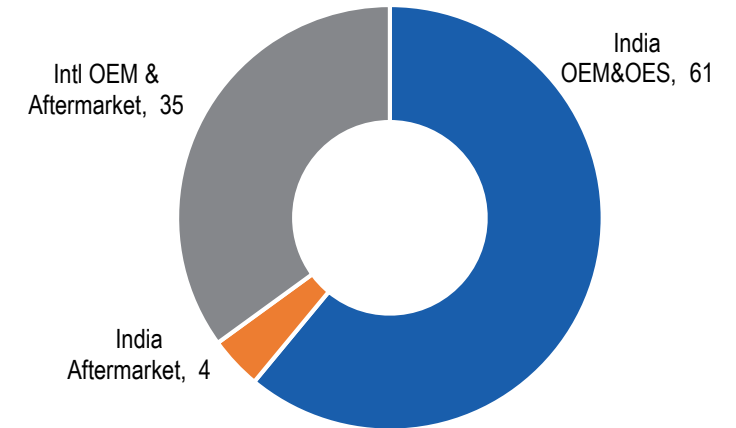

BY VEHICLE SEGMENT (%)

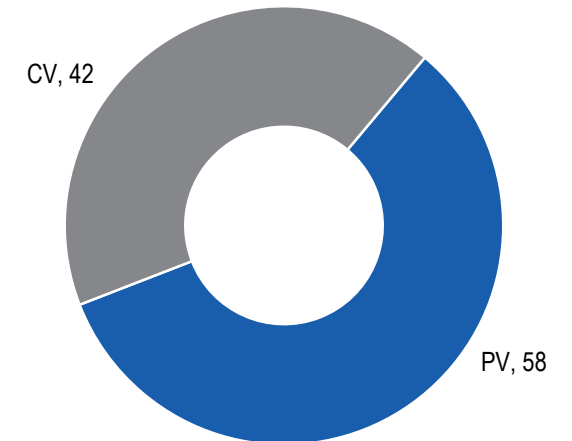

Total Revenue (Rs cr.)

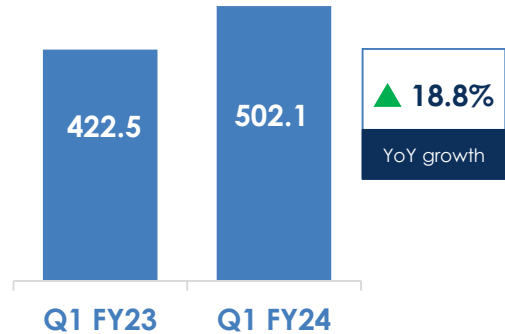

EBITDA (Rs cr.)

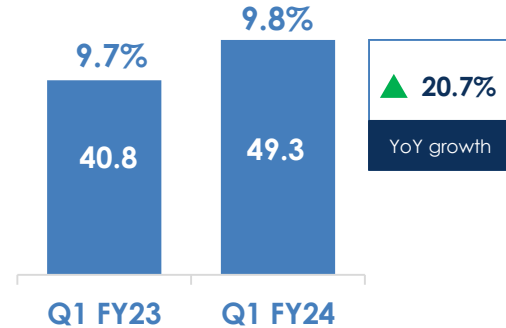

PAT (Rs cr.)

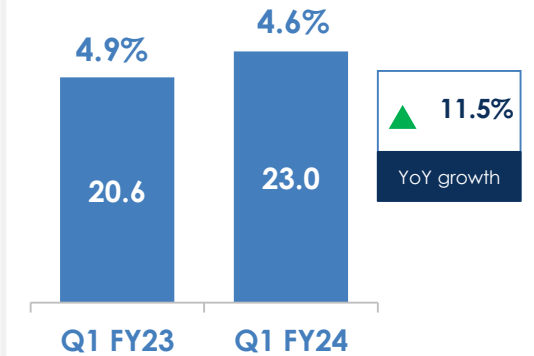

› **Total Revenue increased by 18.8% from Rs. 422.5 Cr in Q1 FY23 to Rs. 502.1 Cr in Q1 FY24**

- Revenue from steering gear products increased 10% supported by strong demand from commercial vehicle segment
- Revenue from occupant safety systems grew 26% supported by strong offtake on domestic and export customers

› **EBITDA increased by 20.7% from Rs. 40.8 Cr in Q1 FY23 to Rs. 49.3 Cr in Q1 FY24**

- EBITDA margin improved by 15 bps supported by higher volumes however off-set by adverse mix.

› **PAT increased by 11.5% from Rs. 20.6 Cr in Q1 FY23 to Rs. 23.0 Cr in Q1 FY24**

Rane NSK Steering Systems Private Limited

Q1FY24 Financial & Operational Performance

Business Drivers

- › Favourable share of business with key customer
- › Strong growth for Manual Steering Column product with new product introductions

Operational Highlights

- › Gujarat plant achieved highest production for a month during the quarter
- › Great Place to Work (GPTW) certified for the first time

Business Split (Q1 FY24)

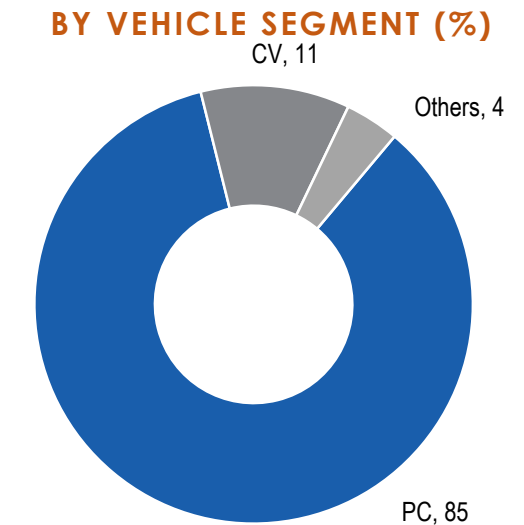
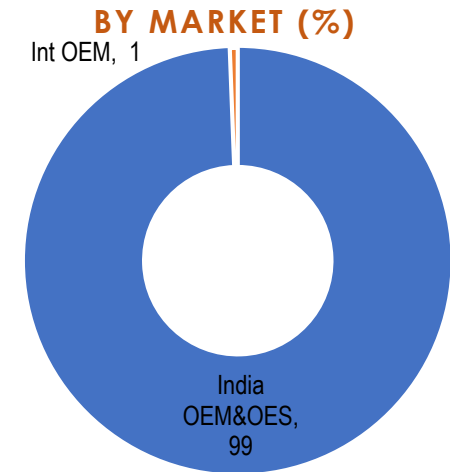

Total Revenue (Rs cr.)

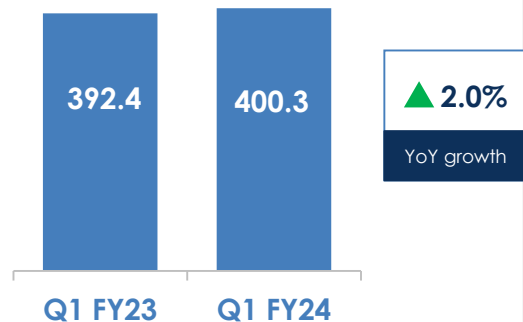

EBITDA (Rs cr.)

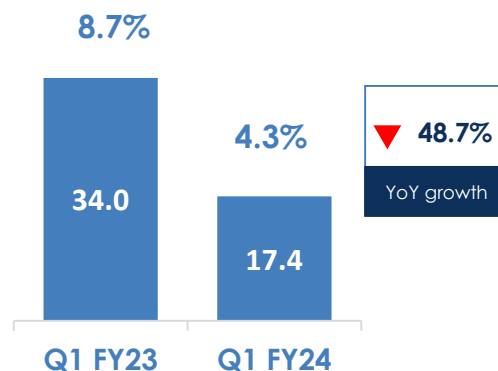

PAT (Rs cr.)

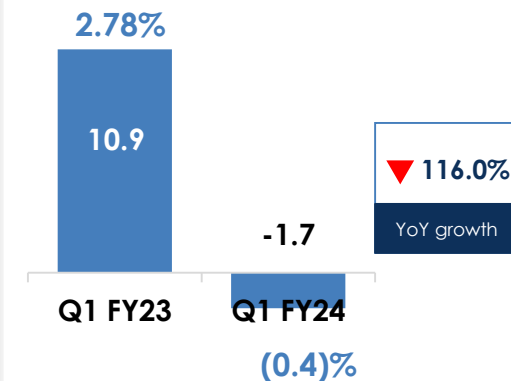

- › **Total Revenue increased by 2% from Rs. 392.4 Cr in Q1 FY23 to Rs. 400.3 Cr in Q1 FY24**
 - Manual steering column business benefitted on account of upcycle in the CV segment
 - EPS business faced slower demand on served models
- › **EBITDA decreased by 48.7% from Rs. 34.0 Cr in Q1 FY23 to Rs. 17.4 Cr in Q1 FY24**
 - Adverse mix and increase in material cost impacted the profitability
- › **PAT decreased from Rs. 10.9 Cr in Q1 FY23 to Loss of Rs. 1.7 Cr in Q1 FY24**



Rane Group

About Us



Founded in 1929 and headquartered in Chennai, Rane Group is one of the preferred OE manufacturer and supplier for global auto majors



The Group serves a variety of industry segments: Passenger Vehicles, Commercial Vehicles, Farm Tractors, Two-wheelers, Three-wheelers, Railways and Stationary Engines



Manufactures Steering and Suspension systems, Friction materials, Valve train components, Occupant safety systems and Light metal casting products.

REVENUE BY MARKET (%)

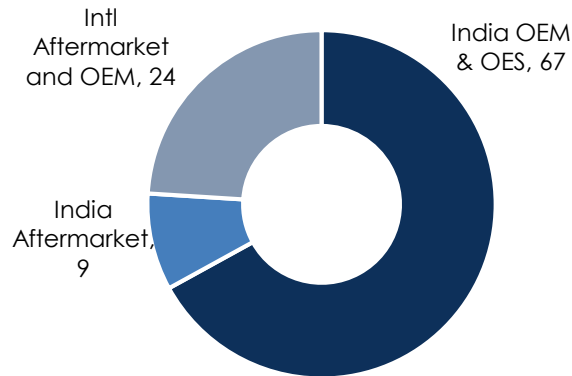

REVENUE BY VEHICLE SEGMENT (%)

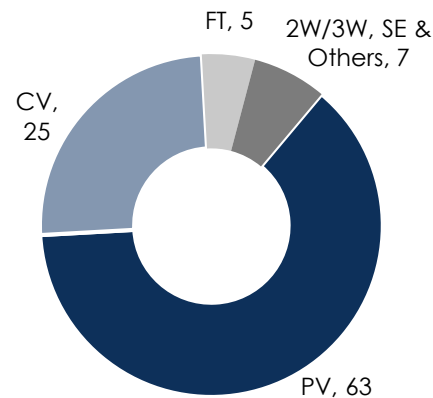

GROUP SALES OF INR 6,690 CR (~USD 820 MN)

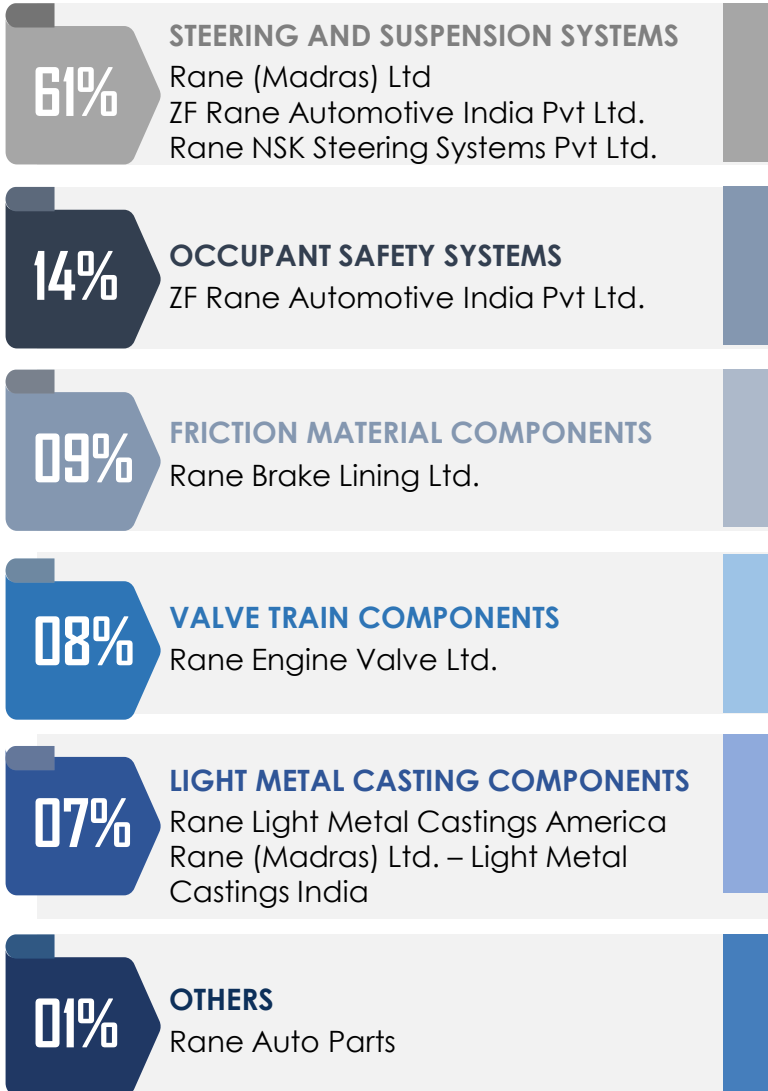

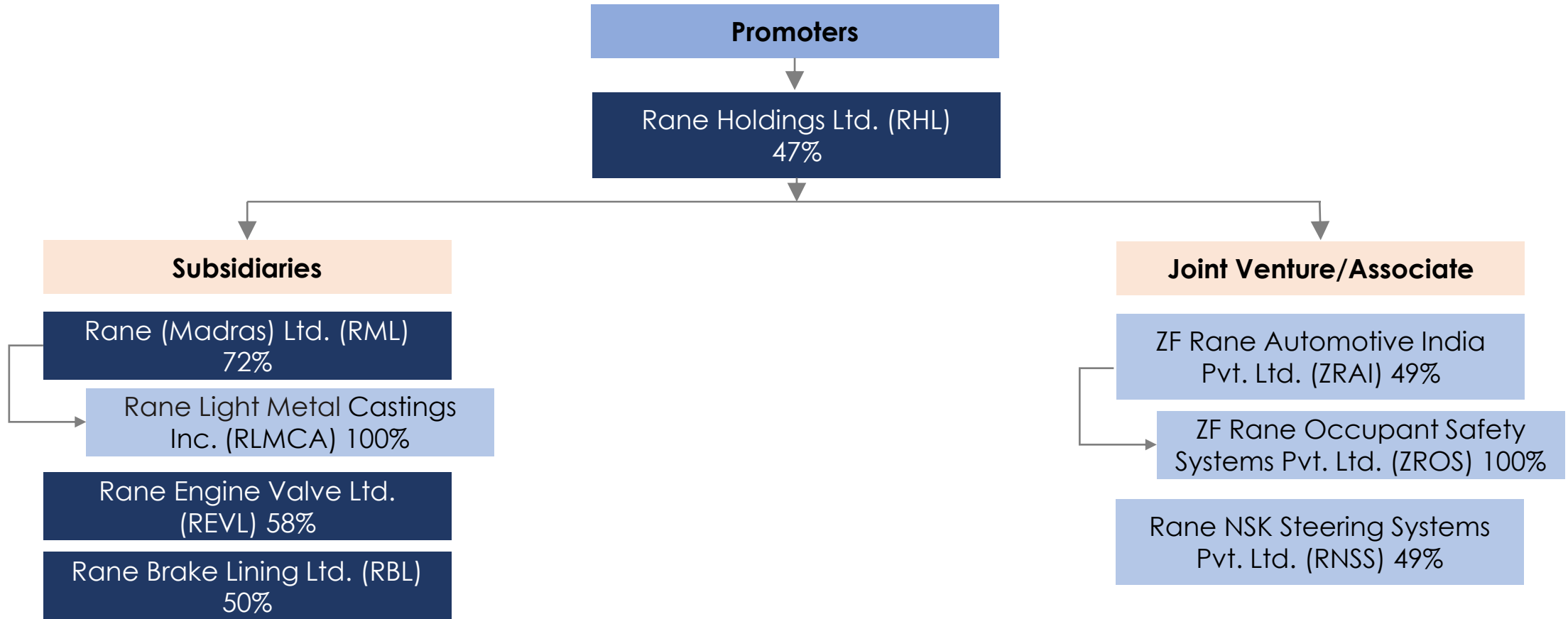

















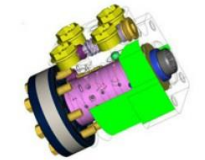

 Listed

Share holding as on 30 June 2023

- Market leader in steering gear and steering linkage products in India. We have started catering to hydraulic products such as HSU and steering cylinders.
- Best in class manufacturing facilities at Chennai, Mysore, Puducherry and Pant Nagar.
- End to end testing facilities in house to validate the products' functional, endurance and environmental parameters.

PRODUCTS

Steering and Linkage Business		Light Metal Castings India Business			Light Metal Castings AMERICA Business	
						
Manual Steering Gears	Suspension Components	Hydraulic Pinion Housings	Pump Housings	EPAS – Pinion & Outboard Housings	Hydraulic – Pinion Housing	Outboard Housing
						
Steering Linkages	Hydraulic Products	Luminaries	Timing-Case Cover	Engine Oil Sump	EPAS – Pinion Housing	
						
		Gear Case	Brake Housing		HVAC Applications	Valve Housing
						
		Battery Housing	Transmission Housing			

MANUFACTURING PLANT

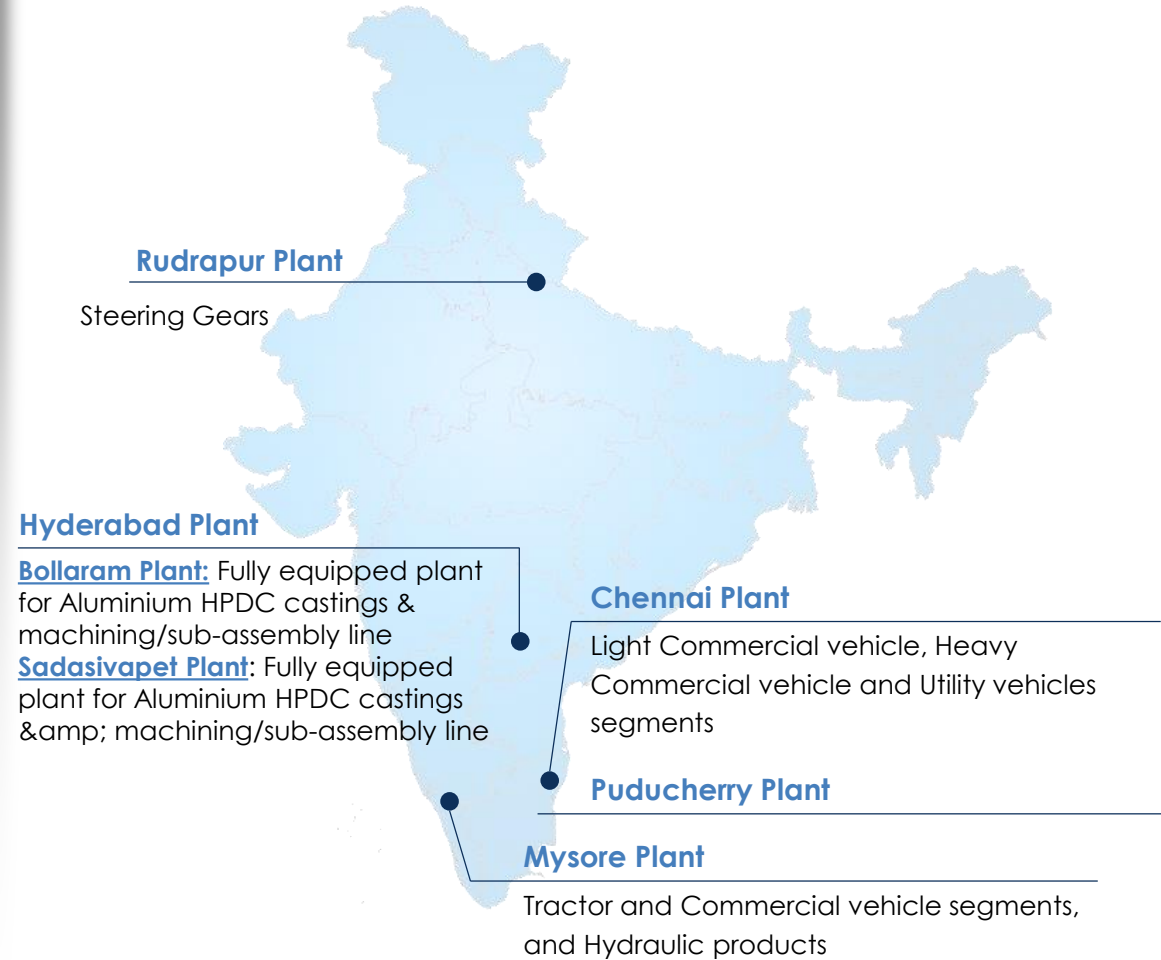

- Incepted In 1959, REVL manufactures valves and valve train components for various engine applications
- Non Automotive applications such as power generation, marine, defence, locomotive, etc.
- Comprehensive test laboratory for material characterisation, simulated test rigs and engine dynamometer test facility.

PRODUCTS

Engine Valves



Valve Guides



Mechanical Tappets



MANUFACTURING PLANT



Hyderabad Plants (2)

Small Valves for 2W and PC
Medium Valves for PC, Industrial and CV

Tumakuru Plant

Medium Valves for CV and Farm Tractors
Large & Extra Large Valves for Industrial, Power Generation and Marine Applications

Chennai Plant

Small Valves for 2W and PC
Medium Valves for Tractors and PC Guides, Tappets

Trichy Plant

Small & medium Valves for 2W, PC and CV

- Established in 1964, RBL is a leader in Friction Products across OEM segments and supplies products to over 15 countries
- Technical collaboration with Nisshinbo Brakes Inc. and TMD Friction
- Library of widely tested and approved formulations to suit diverse market / customer requirements.
- State-of-the-art R&D center equipped with full scale inertia dynamometer, static mu-measurement and NVH study rig.

PRODUCTS

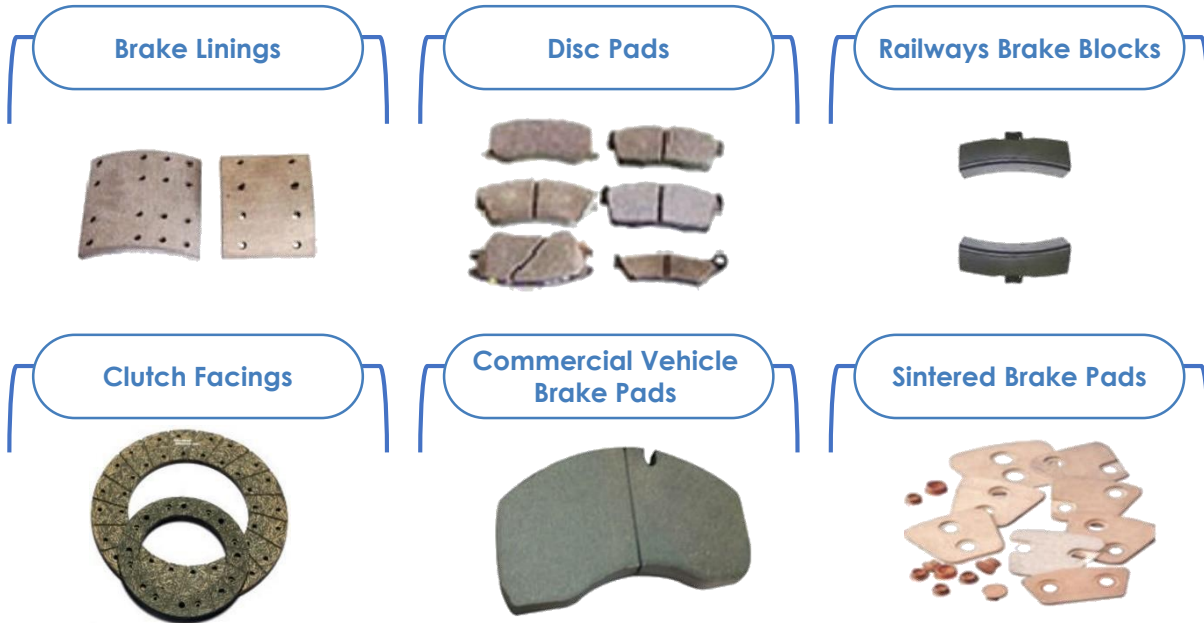

MANUFACTURING PLANT

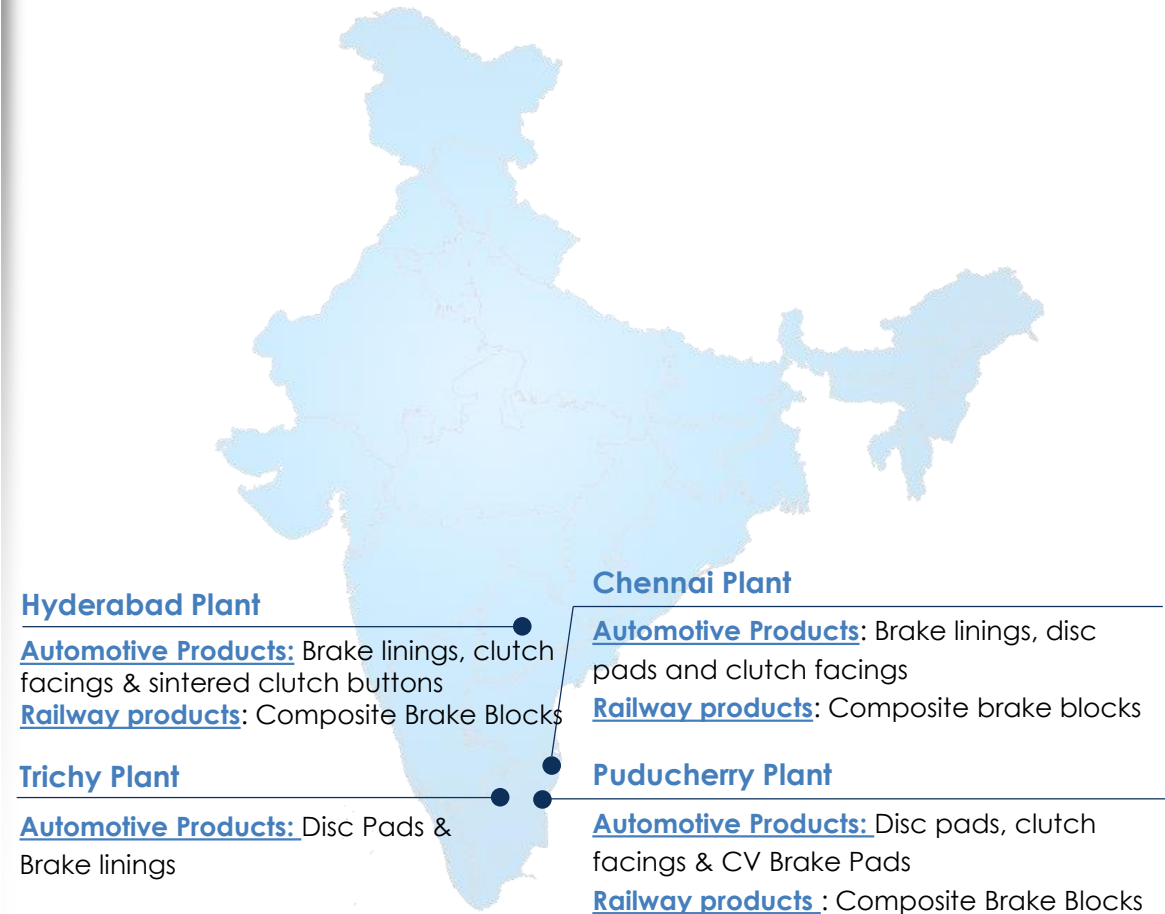

Joint venture partnership with ZF Group, Germany.

Steering Gear Division

- Design, Development and Application capability for complete Hydraulic Power Steering system for all vehicles.
- Advanced design tools for 3D modeling, simulation, FE analysis and CFD.
- State-of-the-art testing facilities for strength, environment, noise, fatigue and durability tests to meet global standards

Occupant Safety Division

- Product range includes different types of airbags and latest seatbelt technologies, Retractor and Anchor pretensioners, Emergency Locking Retractor (ELR), Load Limiters, Child Restraint Seat Belt, Driver Airbag, Passenger Airbag, Side Airbag and Curtain Airbags.
- Extensive testing facilities for seat belts include Extraction and Retraction Force Testing Machine, Retractor Durability Tester, Hot & Cold Chamber, Salt spray chamber, ELR functional tester.
- Equipped with Test lab to carry out testing as per National (IS/AIS), International (ECE/EEC/GS/VSCC), customer specifications and COP testing

PRODUCTS

Steering Gear Division



Occupant Safety Division



MANUFACTURING PLANT

Rudrapur Plant

Steering Gears and Pumps

Chennai Plant (3)

Pump and Power Rack & Pinion division, Occupant Safety Products

Tiruchirapally Plant (2)

Fully integrated gear, Occupant Safety Products

- Joint venture partnership with NSK, Japan.
- State-of-art R&D test lab for validation of steering columns.
- Manufacturing facilities across four locations in Chennai, Bawal, Rudrapur & Ahmedabad.
- Design & Development capability for solid & energy absorbing columns. Development and application capability for EPS.
- Driver comfort, Passenger safety, Ergonomics and NVH requirements are kept as targets while designing steering system.
- Comprehensive test laboratory for extensive research about column performance characteristic validation, strength and durability validation and NVH requirements.
- Design team includes CAD & CAM application experts and software analysts.

PRODUCTS



MANUFACTURING PLANT

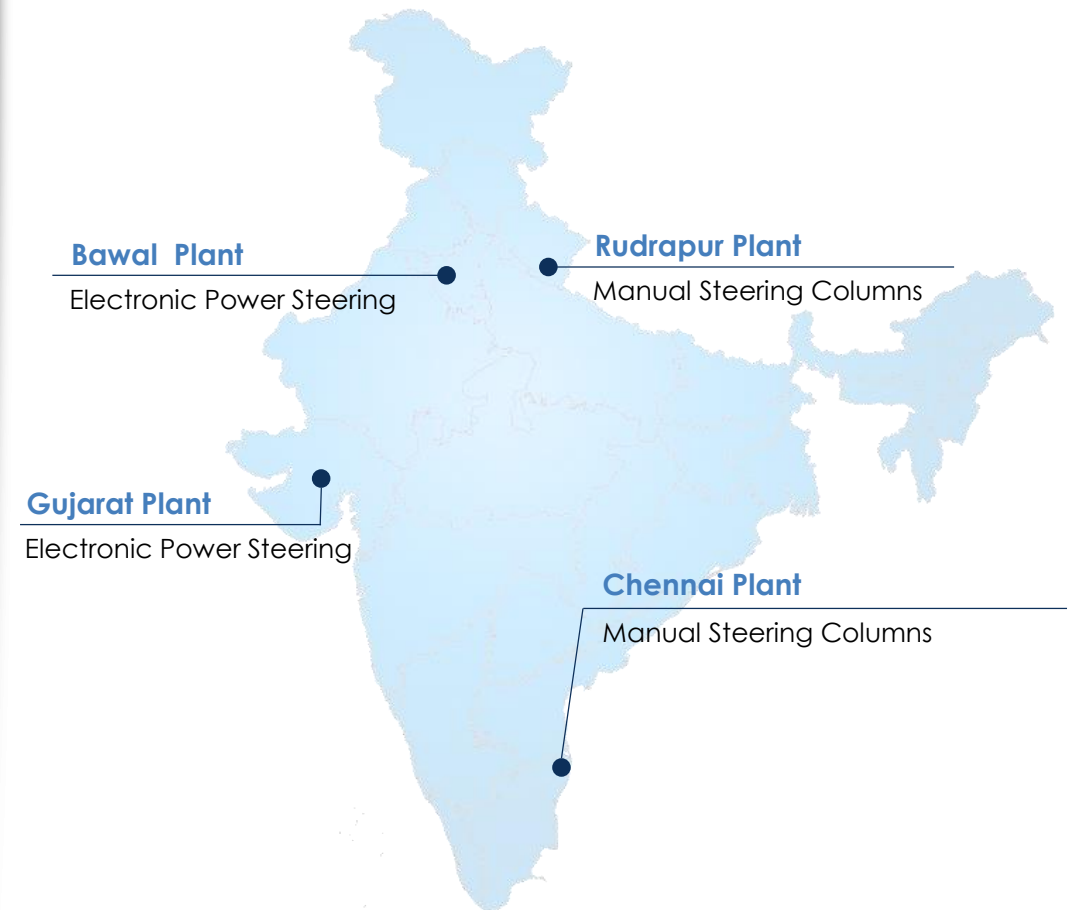

Light Metal Casting Products

Pinion Housing

Engine Timing Case Cover

Outboard Housing

Valve train Components

Engine Valves

Occupant Safety Systems

Seat Belts

Airbags

Friction Materials

Brake Lining

Disc Pad

Upper Control Arm

Stabilizer Link

Lower Control Arm

Steering & Suspension Systems

Suspension Ball Joint

Outer Ball Joint

Inner Ball Joint

Power Steering Pump

Rack & Pinion steering gear
-Mechanical
-Hydraulic

Electric Power Steering Columns

Rane (Madras)

- › Manual Steering Gears
- › Steering Linkages
- › Suspension Components
- › Light Metal Casting Products

Rane Engine Valve

- › Engine Valves

Rane Brake Lining

- › Brake Linings
- › Disc Pads

Rane NSK Steering Systems

- › Electric Power Steering Systems

ZF Rane Automotive India Pvt Ltd.

- › Hydraulic Power Steering systems
- › Seat Belts
- › Airbags

Steering & Suspension Systems



Manual Steering Column



Power Steering Gear



Power Steering Pump



Manual RCB Steering Gear



Drag Link Assembly



Tie Rod Assembly

Hydraulic Cylinder (Twin/multi front axle trucks)



Light Metal Casting Products

Hydraulic Pump Housing



Occupant Safety Systems

Seat Belts



Friction Materials

Brake Lining



Disc Pad



Valve train Components

Valve Guides



Engine Valves

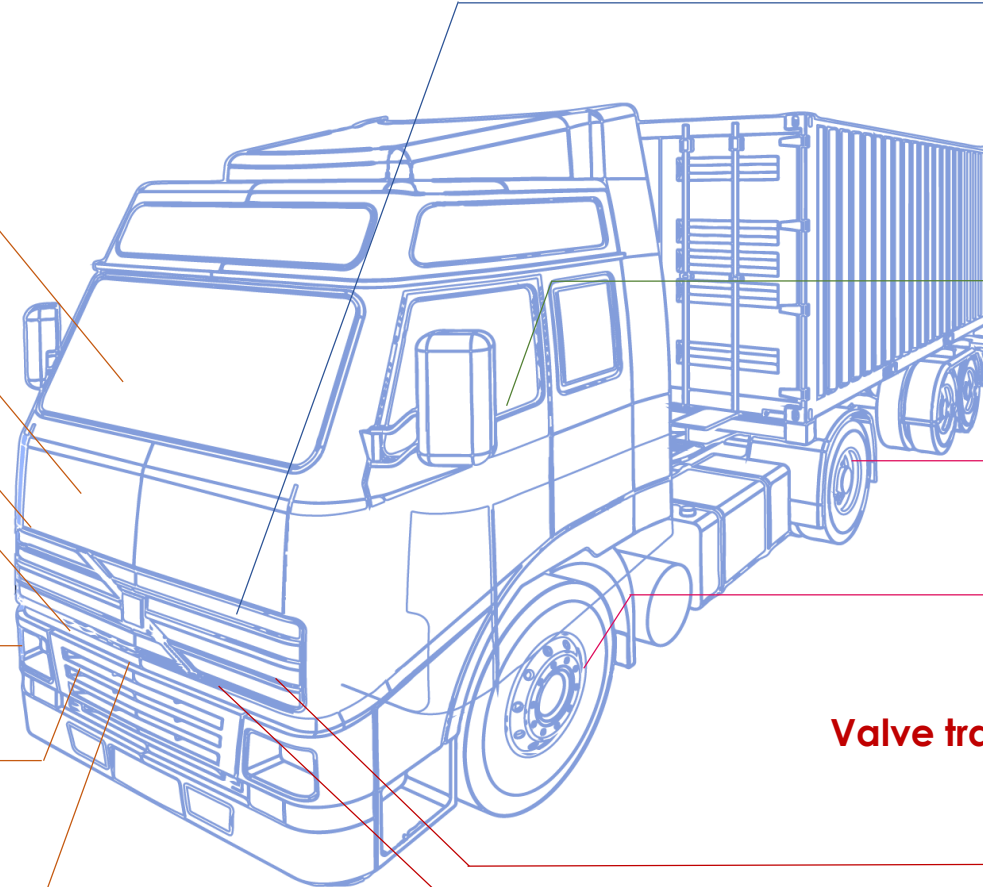

Rane (Madras)

- › Manual Steering Gears
- › Steering Linkages
- › Hydraulic Cylinders
- › Light Metal Casting Products

Rane Engine Valve

- › Engine Valves
- › Valve Guides

Rane Brake Lining

- › Brake Linings
- › Brake Pads

Rane NSK Steering Systems

- › Manual Steering Column

ZF Rane Automotive India Pvt Ltd.

- › Hydraulic Power Steering Systems
- › Seat Belts

Steering & Suspension Systems



Manual Steering /
Column
Manual RCB
Steering Gear



Hydrostatic
Steering Unit



Power Steering
Gear



Drag Link Assembly



Tie Rod Assembly

Hydraulic
Cylinder



Friction Materials

Clutch Facings



Brake Lining

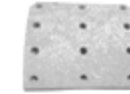

Light Metal Casting Products

Timing Case Covers



Seat Belts



Valve train components

Valve Guides



Engine Valves



Rane (Madras)

- › Manual Steering Gears
- › Steering Linkages
- › Hydraulic Cylinders
- › Hydrostatic Steering Unit
- › Light Metal Casting Products

Rane Engine Valve

- › Engine Valves
- › Valve Guides

Rane Brake Lining

- › Brake Linings
- › Clutch Facings

Rane NSK Steering Systems

- › Manual Steering Column

ZF Rane Automotive India Pvt Ltd.

- › Hydraulic Power Steering systems
- › Seat Belts

Light Metal Casting Products

Battery Box & Cover

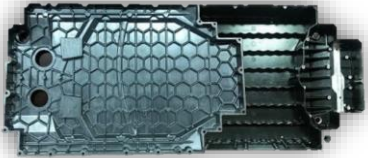

Friction Materials

Disc pad

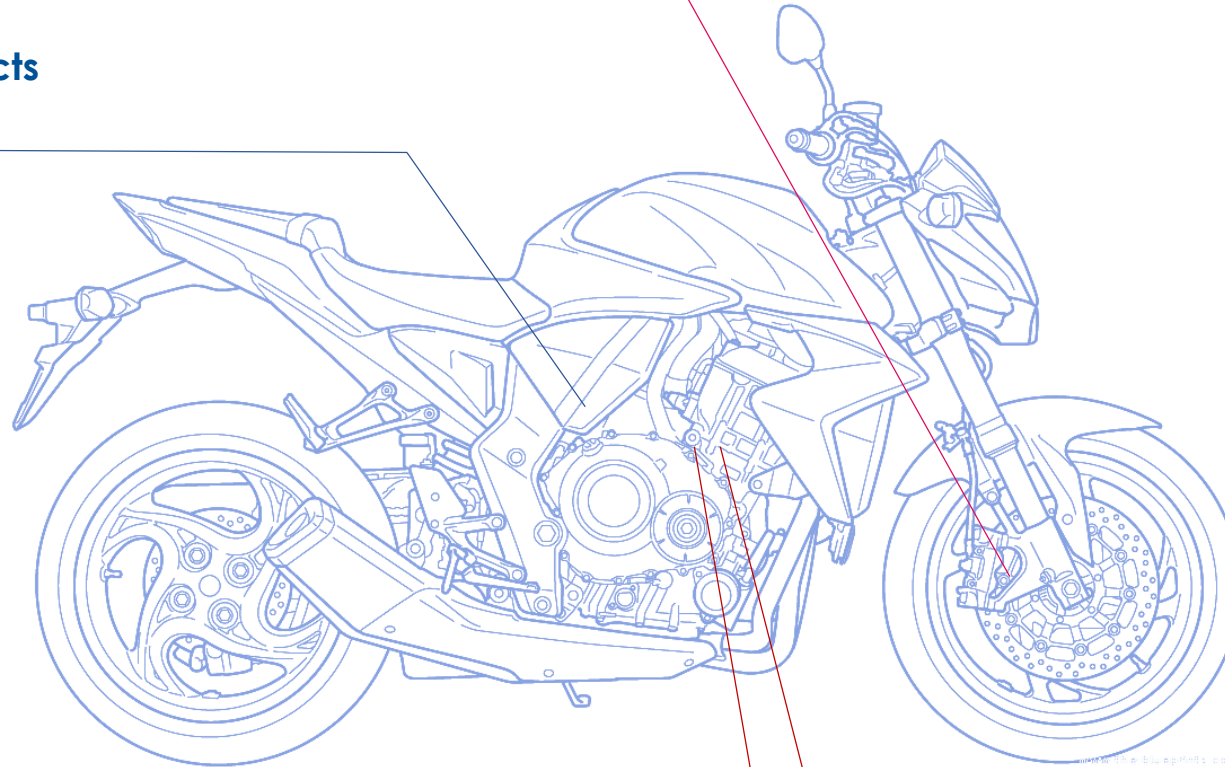

Rane (Madras)

- › Light Metal Casting Products

Rane Brake Lining

- › Disc Pads

Rane Engine Valve

- › Engine Valves
- › Valve Guides

Valve train Components

Valve Guides



Engine Valves



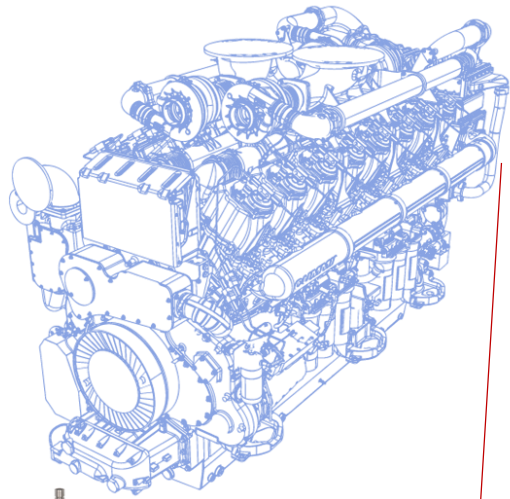

Engine Valves / Valve Guides

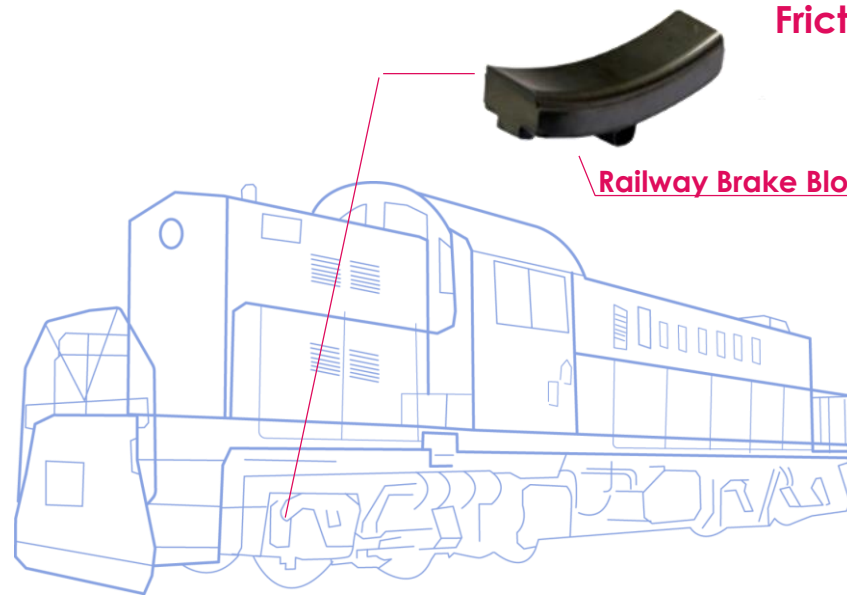
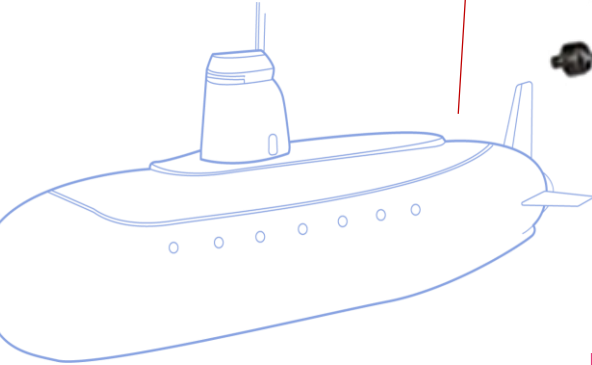

Railway Brake Block

Friction Materials



Sintered Brake Pads

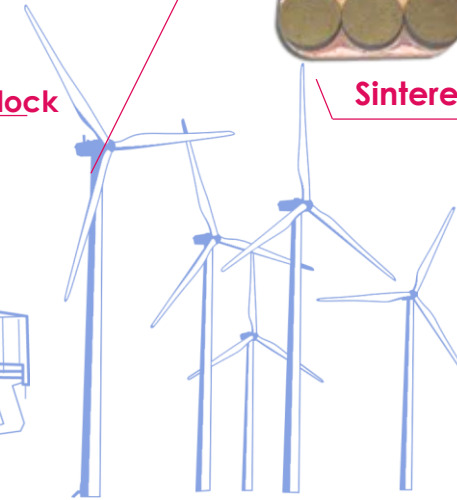

Suspension Ball Joint

Outer Ball Joint

Inner Ball Joint

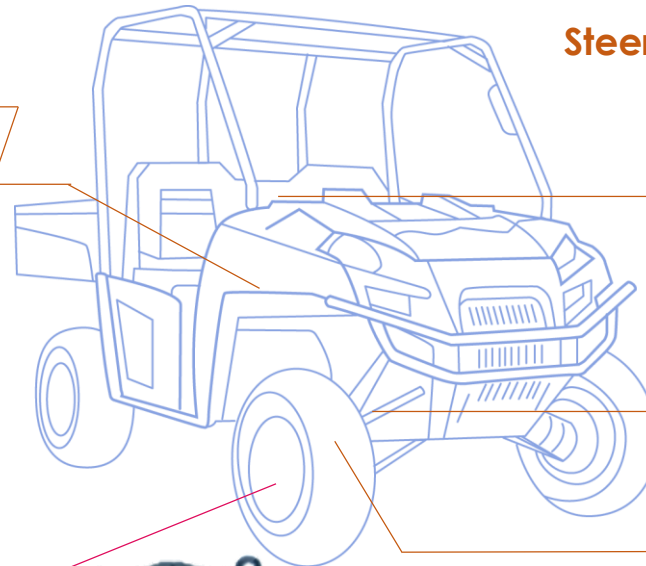

Steering & Suspension Systems



Steering Shafts



Rack & Pinion steering gear -Mechanical



Stabilizer link

Friction Materials
Disc pad



Rane (Madras)

- › Manual Steering Gears
- › Steering Linkages
- › Light Metal Casting Products

Rane Engine Valve

- › Engine Valves
- › Valve Guides

Rane Brake Lining

- › Sintered Brake Pads
- › Railway Brake Block

Rane NSK Steering Systems

- › Steering Shafts

An illustrious journey of over 80 years from distributor of automobile and auto components to winner of Deming prize for manufacturing

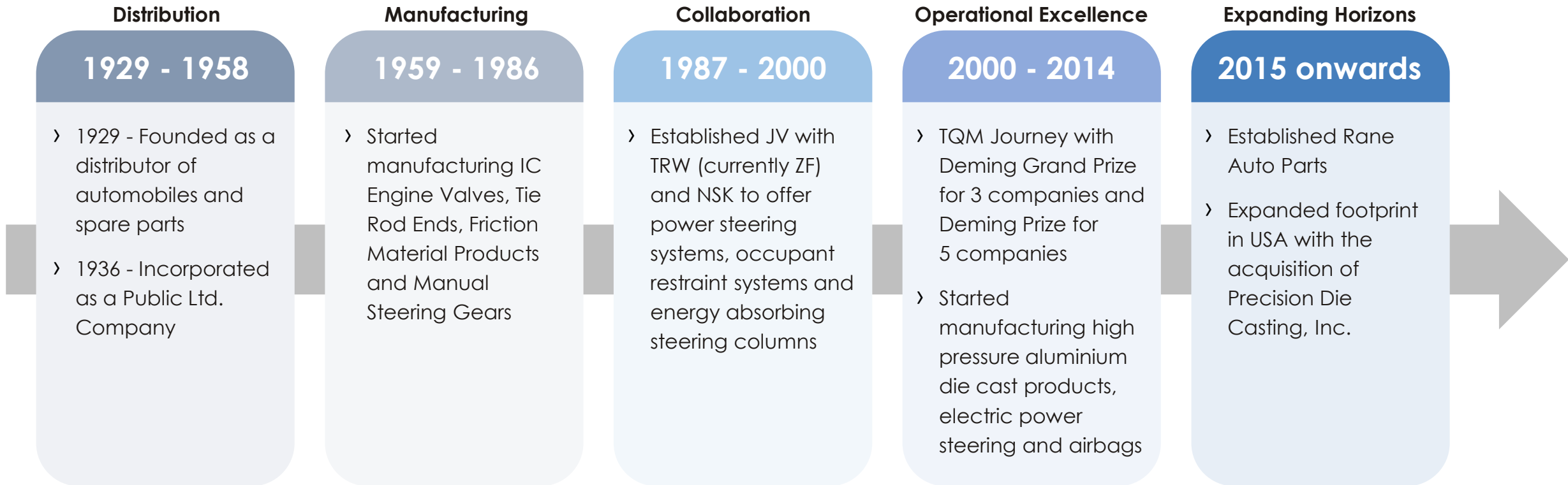



30+ Serve customers in 30+ countries

26 Manufacturing locations across India and USA

Customer Locations Manufacturing Locations Sales Offices



Increasing Group's brand presence in aftermarket through enhanced product portfolio and wider market reach

230 R&D Engineers

42 Functional Test Rigs

26 Strength Test Rigs

62 Durability Test Rigs

33 Environmental Test Rigs

10 Noise Test Rigs

Strong CAE Capabilities – Design, Analysis & Simulation Software



Hydraulic Power Steering Systems and Occupant Safety Systems



Energy Absorbing Steering Columns and Electric Power Steering



Brake Linings, Discs Pads and Clutch Facings

We create and deliver value to our customers

Passenger Vehicle



Commercial Vehicle



Farm Tractor



Two/Three-Wheeler



Other Applications



INDIA



INTERNATIONAL

'Customer at the core' remains our priority on the goal to sustainable growth and profitability



Rane Group

Customer	Award Category
Mahindra & Mahindra	Business Partner of the year – Automotive Division



Rane (Madras)

Customer	Award Category
Volvo Eicher	New Product Development Award
Nexteer TAFE	Perfect Quality Award Best Supplier & Benchmark Award
Maruti Suzuki	Superior Performance Award, Special Support
SML Isuzu	New Product Development Award
Tata Motors	Award for Exceptional Support, Best Supplier – Demand Fulfillment
Toyota Industries	Best Target Achieved Supplier Award



Rane Brake Lining

Customer	Award Category
Brakes India	Best Supplier - Friction
Ashok Leyland	After Market Support Award
Foundation Brake	Business Excellence Award
Endurance	Gold Award for Quality Best Benchmark Award, Best Supplier Award, Consistent Vendor Rating Performance Award



Rane Engine Valve

Customer	Award Category
Groupe Renault	Quality & Customer Satisfaction
John Deere India	Quality Appreciation Award
Volvo Eicher	Quality & Delivery excellence
Renault Nissan	Quality & Customer Satisfaction
Hyundai	Appreciation Award
Cummins India	Superior Quality Award



ZF Rane

Customer	Award Category
Ashok Leyland	Best Performance in Business Alignment-Gold
Isuzu Motors	Most Improved Supplier Award
Tata Motors	Best Supplier Award, Efficiency Award, Best in Class Award
Volvo Eicher	Best Supplier in NPD, Supply Chain
Daimler India	Quality Appreciation Award
Renault Nissan	Best Supplier in Field Quality



Rane NSK

Customer	Award Category
Maruti Suzuki	Efforts in Vendor Import Localisation
Honda Cars	Award for best reduction in CO2
Volvo Eicher	Quality Excellence
Daimler India	Best Technology Support

Rane Values

- › Provide superior products and maintain market leadership
- › Pursue excellence
- › Achieve the highest standard of ethics and integrity

Rane Approach

- › Build strong connections with customers to understand their challenges
- › Strategic investments to improve quality and productivity
- › TQM way of working
- › Emphasis on 'First-time right' policy

Rane Credentials

- › Modern manufacturing facilities with TS 16949 certification
- › State-of-the-art product development and validation capabilities
- › Deming Grand Prize for 3 Rane companies
- › Deming Prize for 5 Rane companies



- › Technology collaboration with top global players



ZF Group, Germany
Hydraulic Power Steering Systems and Occupant Safety Systems



NSK, Japan
Energy Absorbing Steering Columns and Electric Power Steering



Nisshinbo Brake Inc., Japan
Brake Linings, Disc Pads and Clutch Facings

Value Proposition

- › Superior products driven by execution excellence
- › Trusted partner with shorter development lead times
- › Agile manufacturing process and scalable facilities
- › Provide system-level solutions with deep understanding of customer needs
- › With enhanced R&D capabilities, we provide light-weighting, improved safety and performance

**LONG TERM PARTNER OF CHOICE TO LEADING
AUTOMOTIVE COMPANIES AND TIER 1 SUPPLIERS**

An exciting workplace founded on the principles of values, fairness and transparency that:



Provides challenging assignments

Encourages learning

Enhances career opportunities



- › **Organisation Development Excellence Award** for the exceptional practices on **Leadership Development** by Transcendence, Tata Institute of Social Sciences (TISS), 2019
- › Recognized by International Federation of Training and Development Organizations in Best HRD practice category, 2018
- › Award for **Talent Management** from the Employer Branding institute, Singapore, 2012 & 2014
- › Significant Achievement in **HR Excellence**, CII, 2012



Certified as a **Great Workplace** by the Great Place to Work institute, 2023



Systems approach to deliver H&S to our employees

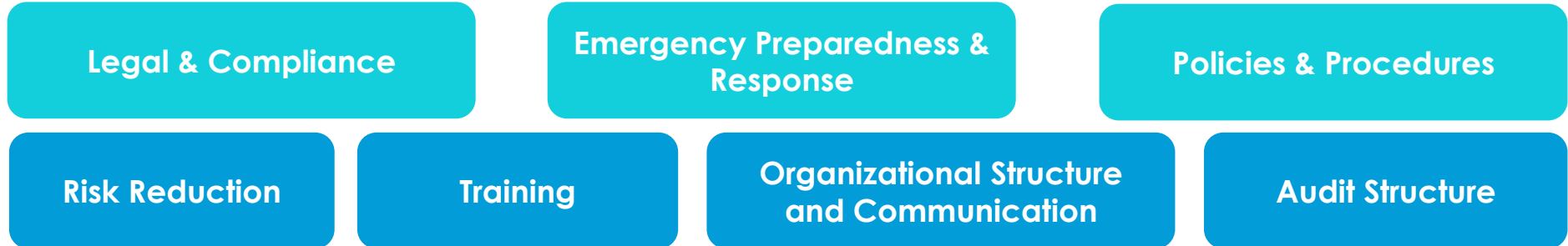

- › Rane Foundation (RF) is a **public charitable trust** founded by Rane's promoters in the year 1967
- › RF is the **main arm for Rane's Corporate Social Responsibility (CSR) initiatives** and is exclusively funded by the Rane companies
- › Initiatives are focused on **education, healthcare, environment and community development**

Rane Polytechnic



Education

- › Institution Development - Rane Polytechnic, Rane Vidyalaya
- › Vocational Training & Skill Development
- › Awareness programs



Healthcare

- › Nutrition program
- › Health camps
- › Medical infrastructure & aid



Environment

- › Plantation drives
- › Infrastructure for sustainability
- › Natural resource preservation



Community Development

- › Providing amenities & sanitation
- › Improving quality of life
- › Rural infrastructure development program

Rane Vidyalaya



Thank You

For further information, please contact:

investorservices@ranegroup.com or diwakar.pingle@in.ey.com

Rane Corporate Centre

"Maithri" 132, Cathedral Road,
Chennai - 600 086, India
www.ranegroup.com

Glossary of Abbreviations

Abbreviation	Expansion	Abbreviation	Expansion
bps	Basis point, 100 bps equal to 1%	PAT	Profit After Tax
BV	Book Value per share	PBT	Profit Before Tax
Cr	Crores	PC	Passenger Car
CV	Commercial Vehicle	PLE	Production Linked Incentive
DPS	Dividend per share	PV	Passenger vehicle
EBITDA	Earnings Before Interest, Tax, Depreciation and Amortization	Pvt	Private
EPS	Earnings per share / Electronic power steering	Q1	Quarter 1
EV	Electric vehicle	Rane T4U	Rane T4U Pvt Limited
FT	Farm Tractors	RBL	Rane Brake Lining Limited
FY	Financial Year	REVL	Rane Engine Valve Limited
HR	Human Resource	RHL	Rane Holdings Limited
		RLMCA	Rane Light Metal Casting Inc
Intl	International	RML	Rane (Madras) Limited
JV	Joint Venture	RNSS	Rane NSK Steering Systems Pvt Limited
LCV	Light Commercial Vehicles	SE	Station Engine
Ltd	Limited	US	United States
M&HCV	Medium & Heavy Commercial Vehicles	USD	United States Dollar
Mn	Million	VRS	Voluntary Retirement Scheme
NPD	New Product Development	YoY	Year-on-Year
OE	Original Equipment	ZRAI	ZF Rane Automotive India Pvt limited
OEM	Original Equipment Manufacturer	ZROS	ZF Rane Occupant Safety Systems Pvt Ltd.
OES	Original Equipment Supplier	2W/3W	Two Wheeler/Three Wheeler

This presentation may contain certain forward looking statements concerning Rane's future business prospects and business profitability, which are subject to a number of risks and uncertainties and the actual results could materially differ from those in such forward looking statements. The risks and uncertainties relating to these statements include, but not limited to risks and uncertainties regarding fluctuations in earnings, our ability to manage growth, competition (both domestic and international), economic growth in India and the target countries for exports, ability to attract and retain highly skilled professionals, government policies and action with respect to investments, fiscal deficits, regulations etc., interest and other fiscal costs generally prevailing in the economy. The company does not undertake to make any announcement in case any of these forward looking statement become materially incorrect in future or update any forward looking statements made from time to time by or on behalf of the Company.