



PPAP Automotive Limited

B-206A ■ Sector-81 ■ Phase-II ■ Noida 201305 ■ Uttar Pradesh ■ India
☎ +91-120-4093901 ✉ info@ppapco.com 🌐 www.ppapco.in

13th May, 2022

The Listing Department
BSE Limited
Phiroze Jeejeebhoy Towers,
Dalal Street,
Mumbai - 400001
Symbol: 532934

The Listing Department
The National Stock Exchange of India Limited
Exchange Plaza,
Bandra Kurla Complex,
Bandra (E), Mumbai - 400051
Symbol: PPAP

Subject: Analysts and Investors Presentation pursuant to Regulation 30 of the Securities and Exchange Board of India (Listing Obligations and Disclosure Requirements) Regulations, 2015.

Dear Sir,

Pursuant to Regulation 30 of the Securities and Exchange Board of India (Listing Obligations and Disclosure Requirements) Regulations, 2015, please find enclosed the Analysts and Investors presentation on the Financial Results of the Company for the quarter and year ended 31st March, 2022.

Yours faithfully,
For **PPAP Automotive Limited**

Abhishek Jain
Chief Executive Officer & Managing Director



PPAP Automotive Limited

TAKING CHALLENGES, TOGETHER
Investor presentation – May 2022



Safe Harbour



This presentation and the accompanying slides (the “Presentation”), which have been prepared by **PPAP Automotive Limited (the “Company”)**, have been prepared solely for information purposes and do not constitute any offer, recommendation or invitation to purchase or subscribe for any securities, and shall not form the basis or be relied on in connection with any contract or binding commitment whatsoever. No offering of securities of the Company will be made except by means of a statutory offering document containing detailed information about the Company.

This Presentation has been prepared by the Company based on information and data which the Company considers reliable, but the Company makes no representation or warranty, express or implied, whatsoever, and no reliance shall be placed on, the truth, accuracy, completeness, fairness and reasonableness of the contents of this Presentation. This Presentation may not be all inclusive and may not contain all of the information that you may consider material. Any liability in respect of the contents of, or any omission from, this Presentation is expressly excluded.

This presentation contains certain forward-looking statements concerning the Company’s future business prospects and business profitability, which are subject to a number of risks and uncertainties and the actual results could materially differ from those in such forward looking statements. The risks and uncertainties relating to these statements include, but are not limited to, risks and uncertainties regarding fluctuations in earnings, our ability to manage growth, competition (both domestic and international), economic growth in India and abroad, ability to attract and retain highly skilled professionals, time and cost over runs on contracts, our ability to manage our international operations, government policies and actions regulations, interest and other fiscal costs generally prevailing in the economy. The Company does not undertake to make any announcement in case any of these forward looking statements become materially incorrect in future or update any forward-looking statements made from time to time by or on behalf of the Company.



Financial Highlights



Key Highlights



FY22 Performance

- The company reported a consolidated revenue of INR 421.9 crore (30.9% YoY growth). The company could grow its revenue despite couple of covid waves, geo-political tensions and headwinds hovering around auto industry
- Consolidated EBITDA witnessed a sharp uptick of 17% to INR 38.6 crore on a YoY basis
- For the year, the Parts contributed 92% of the total revenues while Tools & Others contributed 8% of the revenues
- The capacity utilization for the full year stood at 64%
- During the year, PPAP had begun supplying parts to newly launched vehicles of marquee OEMs such as:
 - Maruti Suzuki's **Baleno**
 - Volkswagen's **KUSHAQ**
 - Morris Garage's **Astor**
 - Maruti Suzuki's **Celerio**
 - Skoda's **Slavia**
- PPAP has received Zero defect award from Hyundai and Zero PPM award and Best Energy Reduction Innovation award from Toyota
- The Company had received "The Machinist Super Shopfloor Awards 2021", organised by Times of India Group in the category of Maintenance for the financial year 2021
- **The board has recommended a final dividend of Rs 1.5 Per Share for Face Value of Rs 10 each (15% of Face Value)**

Management Commentary



Commenting on the results and performance for Q4 & FY22, Mr. Ajay Kumar Jain, Chairman & MD of PPAP Automotive Ltd said:

“Financial Year 2022 has been a challenging year for the Industry. The industry encountered many challenges emerging from the deadly second wave of Covid, semi conductor shortages as well as the Russia-Ukraine war. Despite all these unprecedented challenges, Company’s operating income grew by 27.4% on standalone basis and 30.9% on a consolidated basis in FY22.

The demand for vehicles continues to be strong. The semi conductor shortage seems to be easing. Although it may take another year to completely come out of this risk. With easing of covid related restrictions, there is positive outlook all over. Due to increase in demand, the capacity utilization of the company increased to 72% in Q4FY22. With our focus on achieving higher growth through addition of new customers and continual improvement in operation efficiency, company has been able to maintain an EBITDA margin at 10.4% in this quarter.

The industry is facing unprecedented challenges to manage its supply chain arising out of the geo-political tensions, started in the last quarter.”



Key Highlights



FY22
Performance

Revenue

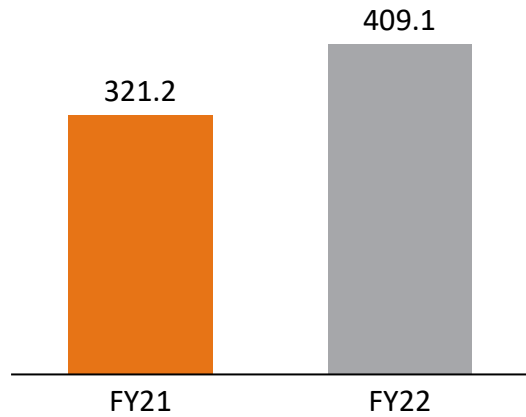

EBITDA

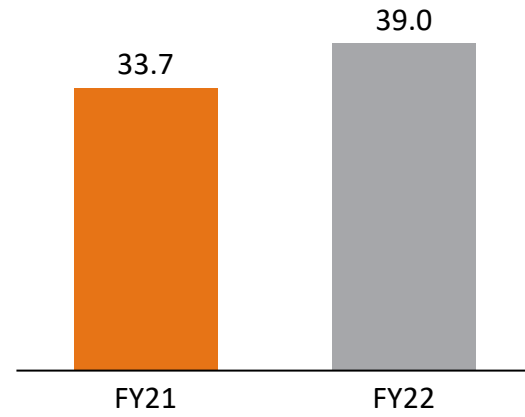

PAT

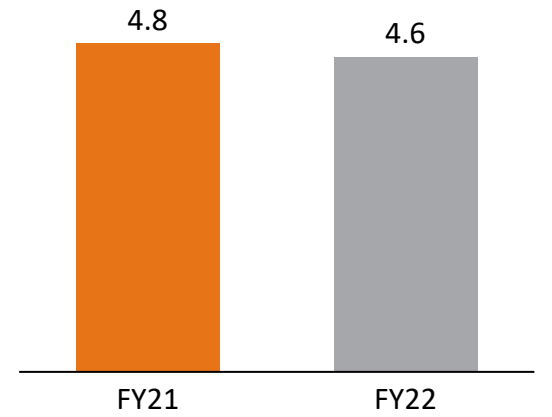

Quarterly
Performance

Revenue

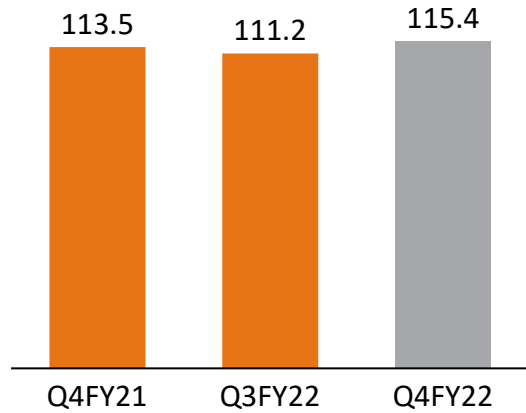

EBITDA

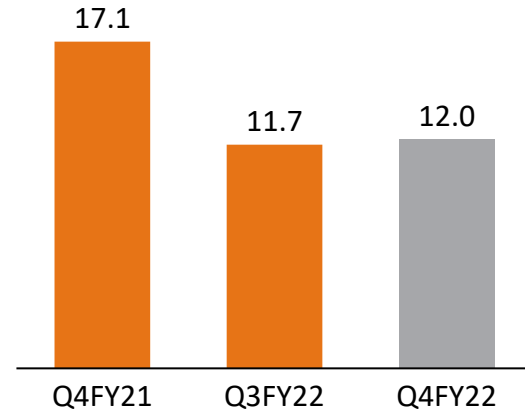

PAT

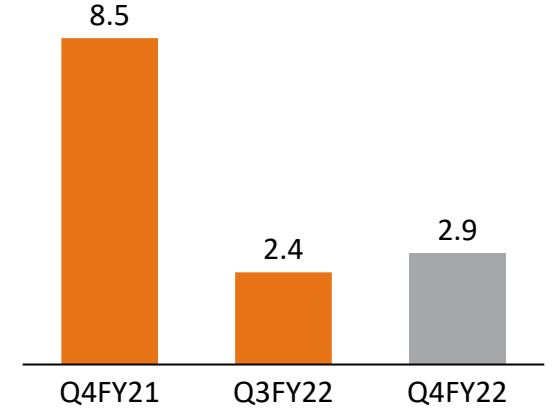

> Segmental Breakup

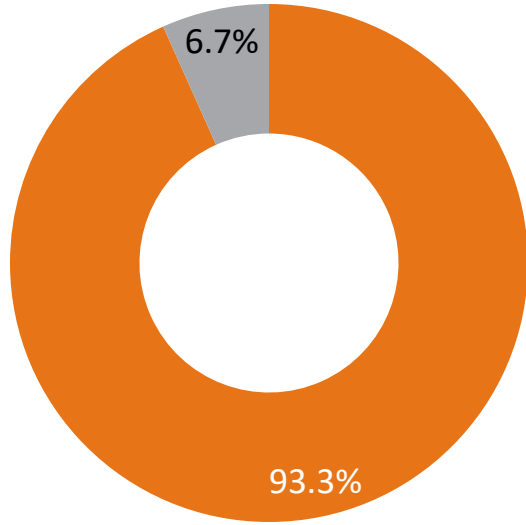

FY21

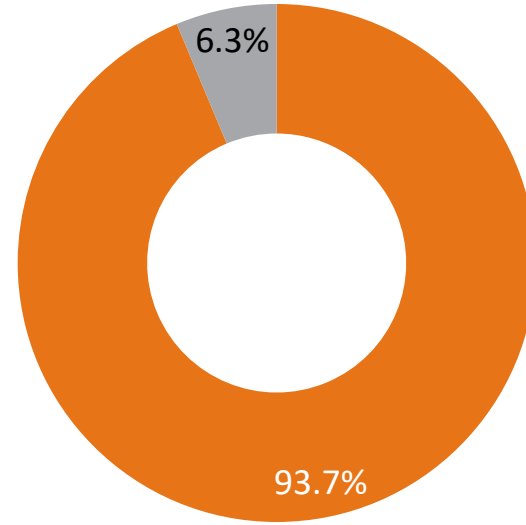

Q4FY21

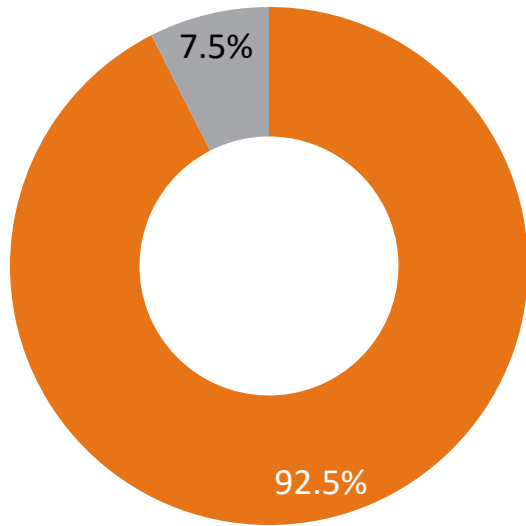

FY22

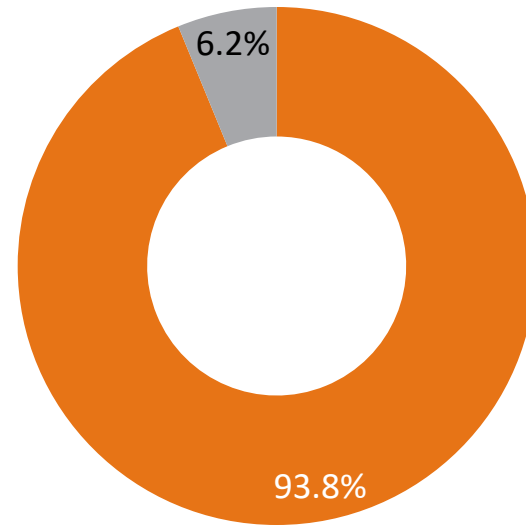

Q4FY22

Parts Tools & Others



Standalone P&L – Q4 & FY22



Particulars (INR Cr)	Q4 FY22	Q3 FY22	Q-o-Q (%)	Q4 FY21	Y-o-Y (%)	FY22	FY21	Y-o-Y (%)
Revenue from operations	115.4	111.2	3.7%	113.5	1.6%	409.1	321.2	27.4%
COGS	70.0	68.3		64.7		247.1	182.6	
Gross Profit	45.3	42.9	5.6%	48.8	-7.1%	162.0	138.6	16.9%
Gross Profit Margin	39.3%	38.6%		43.0%		39.6%	43.1%	
Employee Expenses	17.7	17.5		17.3		69.6	61.2	
Other Expenses	15.6	13.8		14.4		53.3	43.6	
EBITDA	12.0	11.7	3.2%	17.1	-29.7%	39.0	33.7	15.8%
EBITDA Margin	10.4%	10.5%		15.1%		9.5%	10.5%	
Other Income	0.7	0.6		2.0		2.0	2.6	
Depreciation	7.1	7.5		6.6		29.0	26.3	
Finance Cost	1.8	1.7		1.2		6.0	3.7	
Profit before Tax	3.8	3.1		11.3		6.1	6.3	
Tax expenses	1.0	0.8		2.8		1.5	1.5	
Profit for the year	2.9	2.3	22.6%	8.5	-66.4%	4.6	4.8	-5.1%
PAT Margins	2.5%	2.1%		7.5%		1.1%	1.5%	
EPS	2.1	1.7		6.1		3.3	3.4	

Standalone Balance sheet



Liabilities (INR Cr)	Mar-22	Mar-21
Equity		
Equity Share capital	14.0	14.0
Other Equity	298.8	295.8
Non Controlling Interest	0.0	0.0
Total Equity	312.8	309.8
Financial liabilities		
(i) Borrowings	72.4	42.3
(ii) Other Financial liabilities	0.2	0.0
Provisions	6.3	7.3
Other non current Liability	0.0	0.0
Deferred tax liabilities (Net)	7.1	7.0
Total Non Current Liabilities	86.6	56.6
Financial liabilities		
(i) Borrowings	19.4	7.3
(ii) Trade Payables	46.9	47.8
(iii) Other financial liabilities	5.8	7.7
(iv) Lease liabilities	0.5	0.0
Provisions	0.8	0.8
Other current liabilities	17.5	13.5
Current tax liabilities (Net)	0.0	0.7
Total Current Liabilities	90.9	77.8
Total Equity and Liabilities	490.3	444.2

Assets (INR Cr)	Mar-22	Mar-21
Non Current Assets		
Property, Plant and Equipment	261.4	230.6
Capital work-in-progress	20.8	20.1
Other Intangible Asset	8.8	8.9
Investment Property	1.1	0.0
Intangible assets Under Development	0.0	0.2
Right of Use Asset	1.1	0.0
Financial Assets		
(i) Investments	63.0	55.3
(ii) Loans	0.0	1.8
(iii) Other financial assets	3.7	3.0
Deferred Tax Assets (net)	0.0	0.0
Other non-current assets	10.3	11.0
Total Non Current Assets	370.2	330.9
Current Assets		
Inventories	42.9	41.8
Financial Assets		
Investments	2.7	0.0
(i) Trade receivables	52.2	61.9
(ii) Cash and cash equivalents	0.2	1.0
(iii) Other bank balances	0.1	0.1
(iv) Loans	7.5	0.5
(v) Other financial assets	1.8	0.5
Current Tax Assets(Net)	1.2	0.0
Other current assets	11.5	7.6
Total Current Assets	119.3	113.6
Total Assets	490.3	444.2



Standalone Cash Flow



Particulars (INR Cr)	Mar-22	Mar-21
Net Profit Before Tax	6.1	6.3
Adjustments for: Non Cash Items / Other Investment or Financial Items	31.5	27.0
Operating profit before working capital changes	37.6	33.3
Changes in working capital	-0.7	-2.2
Cash generated from Operations	36.9	31.2
Direct taxes paid (net of refund)	-3.4	-1.1
Net Cash from Operating Activities	33.4	30.1
Net Cash from Investing Activities	-70.2	-49.4
Net Cash from Financing Activities	36.0	18.3
Net Increase in Cash and Cash equivalents	-0.8	-1.1
Add: Cash & Cash equivalents at the beginning of the period	1.0	2.1
Cash & Cash equivalents at the end of the period	0.2	1.0

Consolidated P&L – Q4 & FY22



Particulars (INR Cr)	Q4 FY22	Q3 FY22	Q-o-Q (%)	Q4 FY21	Y-o-Y (%)	FY22	FY21	Y-o-Y (%)
Revenue from operations	122.6	114.6	7.0%	114.1	7.5%	421.9	322.2	30.9%
COGS	75.5	70.5		64.9		255.8	183.0	
Gross Profit	47.1	44.1	6.8%	49.2	-4.2%	166.1	139.2	19.5%
Gross Profit Margin	38.4%	38.5%		43.1%		39.4%	43.2%	
Employee Expenses	18.8	17.7		17.7		72.2	62.2	
Other Expenses	16.2	14.5		14.6		55.2	44.1	
EBITDA	12.1	11.9	2.0%	16.9	-28.2%	38.6	32.9	17.3%
EBITDA Margin	9.9%	10.4%		14.8%		9.1%	10.2%	
Other Income	0.3	0.3		1.7		1.0	2.1	
Depreciation	7.3	7.7		6.7		29.5	26.5	
Finance Cost	2.0	1.8		1.2		6.5	3.8	
Profit before Tax	1.7	1.8		9.6		0.1	3.3	-
Tax expenses	0.8	0.7		2.6		0.9	1.1	
Profit for the year	0.9	1.1	-25.0%	7.0	-87.9%	-0.8	2.1	-
PAT Margins	0.7%	1.0%		6.2%		-0.2%	0.7%	
EPS	0.6	0.8		5.0		-0.6	1.5	

Consolidated Balance sheet



Liabilities (NR Cr)	Mar-22	Mar-21
Equity		
Equity Share capital	14.0	14.0
Other Equity	289.9	292.2
Non Controlling Interest	0.0	0.0
Total Equity	303.9	306.2
Financial liabilities		
(i) Borrowings	78.9	44.6
(ii) Lease liabilities	0.9	0.0
(iii) Other Financial liabilities	0.1	0.0
Provisions	6.4	7.3
Other non current Liability	0.0	0.0
Deferred tax liabilities (Net)	6.0	6.7
Total Non Current Liabilities	92.2	58.5
Financial liabilities		
(i) Borrowings	29.2	7.6
(ii) Trade Payables	48.6	47.9
(iii) Other financial liabilities	6.4	7.9
(iv) Lease liabilities	0.8	0.0
Provisions	0.9	0.8
Other current liabilities	17.7	13.6
Current tax liabilities (Net)	0.0	0.7
Total Current Liabilities	102.7	78.5
Total Equity and Liabilities	499.5	443.2

Assets (NR Cr)	Mar-22	Mar-21
Non Current Assets		
Property, Plant and Equipment	273.9	234.9
Capital work-in-progress	20.8	20.1
Other Intangible Asset	8.8	9.0
Intangible assets Under Development	0.7	0.2
Right of Use Asset	1.6	0.0
Financial Assets		
(i) Investments	42.9	46.4
(ii) Loans	0.0	1.8
(iii) Other financial assets	5.1	3.0
Deferred Tax Assets (net)	0.0	0.0
Other non-current assets	10.3	10.7
Total Non Current Assets	364.2	326.1
Current Assets		
Inventories	56.1	45.0
Financial Assets		
Investments	2.7	0.0
(i) Trade receivables	55.9	60.4
(ii) Cash and cash equivalents	0.4	1.3
(iii) Other bank balances	0.1	0.2
(iv) Loans	0.0	0.5
(v) Other financial assets	1.8	1.7
Current Tax Assets(Net)	1.2	0.0
Other current assets	17.2	8.1
Total Current Assets	135.4	117.2
Total Assets	499.5	443.3

Consolidated Cash Flow



Particulars (INR Cr)	Mar-22	Mar-21
Net Profit Before Tax	0.1	3.2
Adjustments for: Non Cash Items / Other Investment or Financial Items	36.7	28.6
Operating profit before working capital changes	36.9	31.9
Changes in working capital	-12.3	-4.4
Cash generated from Operations	24.6	27.5
Direct taxes paid (net of refund)	3.6	-1.1
Net Cash from Operating Activities	21.0	26.4
Net Cash from Investing Activities	-70.9	-48.9
Net Cash from Financing Activities	41.9	20.6
Net Increase in Cash and Cash equivalents	-0.9	-1.9
Add: Cash & Cash equivalents at the beginning of the period	1.3	3.2
Cash & Cash equivalents at the end of the period	0.4	1.3



Company Overview

Business – at a Glance



Tool Business

- The Company established its tooling facility in 2008 for captive purpose
- In 2020, this facility has been commercialized as a profit center
- Plastic injection molds upto 1.5 m * 1.0 m can be manufactured for Automotive, White Goods, Electrical Industry applications

Automotive Parts Business

- Core competence in developing Automotive Body Sealing systems and Interior and Exterior Injection molded parts
- Enhancing per car contribution by adding more products and customers in all segments (PV / 2 W / CV / Tier 1)
- PPAP is focused on development of value-added products through in house design and technology development capabilities
- Focusing on Electric Vehicles (all products are engine agnostic products)

Aftermarket Business

- The Company has commenced with development of aftermarket parts and sales of automotive accessories through wholly owned subsidiary.
- Establishing additional distribution network for offline sales on pan India basis
- Established e-commerce network for online sales through own website and e-commerce portals



EV Component Business

- The Company has forayed in manufacturing of EV components for Electric cycles, 2-Wheeler and 3-Wheeler Applications
- The production of Battery packs for Electric cycles, 2-Wheelers and 3-Wheelers have been commenced
- Focused on development of value-added products through in house design and technology development capabilities

Pail Container Business

- The company has developed a product range of PAIL CONTAINERS
- The company has started supplies to agriculture sector and is now focusing on expanding its customer base to Paint and Lubrication industry
- Railways, Construction, Industrial Products need to be started

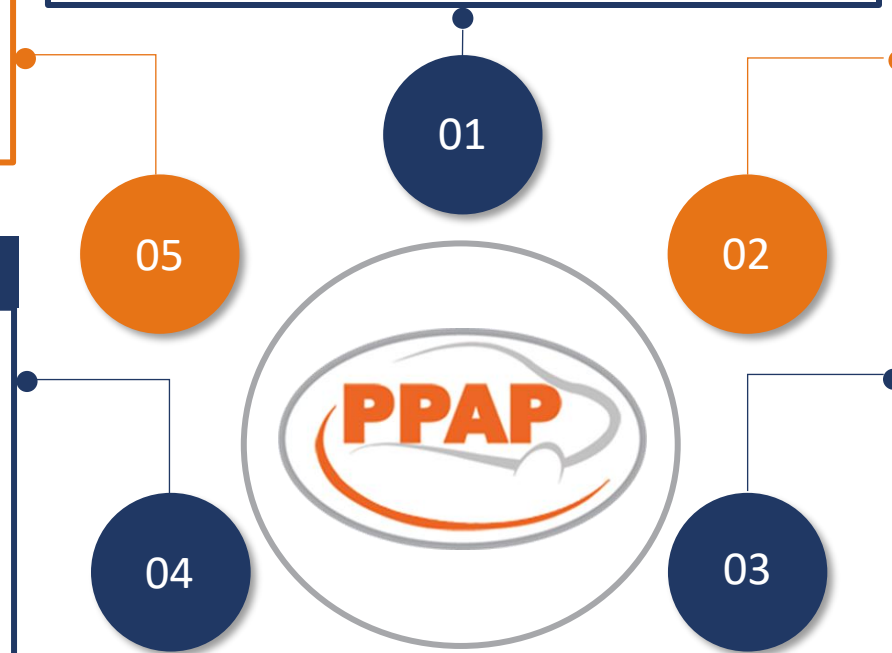

Company Ethos



Vision Statement

To be

our customer's

No. 1 supplier



Mission Statement

To be a global level excellence company,
with an inspiring work culture,
for serving our customers and our society,
by exceeding the expectations,
of all our stakeholders



Our Values

- Trustworthiness
- Mutual Respect
- Creativity
- Co-operation
- Excellence

Journey Towards Excellence...

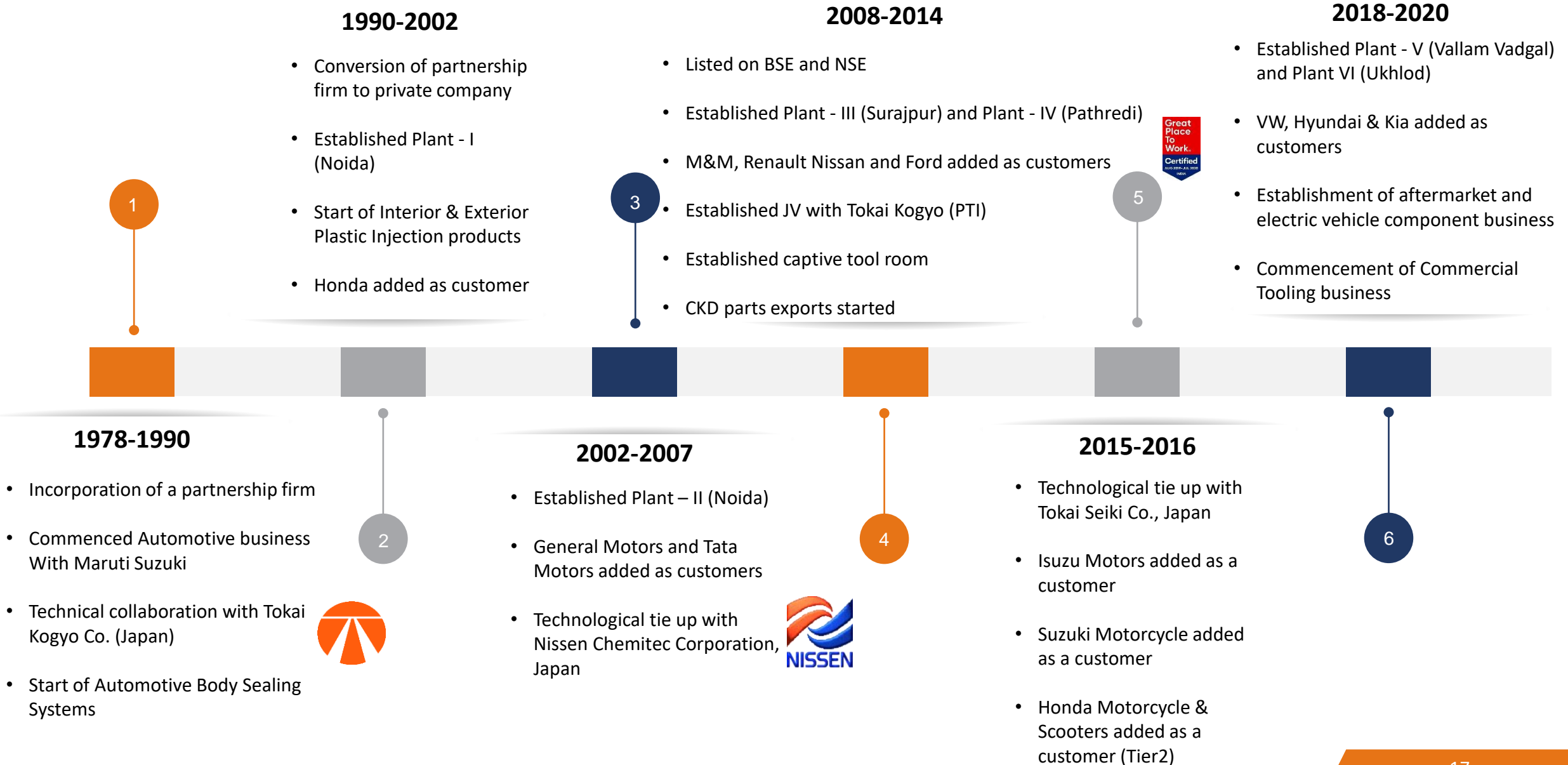



Board of Directors



Ajay Kumar Jain
Chairman &
Managing Director

Bachelor of Commerce from Shri Ram College of Commerce, Delhi University

Associated with the Company since inception with experience of over 45 years in polymer processing industry and over 30 years in the automotive industry

President of Toyota Kirloskar Supplier Association



Bhuwan Kumar Chaturvedi
Independent Director

B.E. (Mech.) from I.I.T. Roorkee and M.B.A. from IIM, Ahmedabad

Has a rich and diverse top management experience in the field of automobile, auto components, engineering, etc.

Associated with Tata Motors, Eicher and Hindustan Motors

President of Tractor Manufacturers Association & Member of CII National Council



Pravin Kumar Gupta
Independent Director

A Fellow Member of the Institute of Chartered Accountants of India

Managing Partner of K.S. Gupta Co., Chartered Accountants (Est.: 1955) with over 35 years of experience.

He has in depth knowledge and experience in the field of Corporate Finance, Taxation, Accounts and Audit



Celine George
Independent Director

PGDM in Business Economics from Delhi University, PGDIM from IMI Delhi and Chevening Gurukul Scholar from London School of political science & Economics

Associated with ONGC, TCS, Cairn Energy, Max healthcare

She has over 30 years of experience in the areas of Leadership, Business Transformation and HR



Vinay Kumari Jain
Non-Executive Director

Bachelor of Science from Delhi University

Founding partner of our Company

Associated with the business since inception

Work experience of over three decades. She possess a deep understanding of automotive business



Abhishek Jain
CEO & Managing Director

Bachelor of Science in Industrial Engineering from Purdue University, USA

Work experience of over 15 years

Chairman of North region Honda Suppliers Club

Coordinator Zone 2 Automotive Component Manufacturers Association Northern Region



Operating Locations...

The Company's state of the art manufacturing facilities are strategically located across the PVs automotive hubs in Northern, Southern and Western India

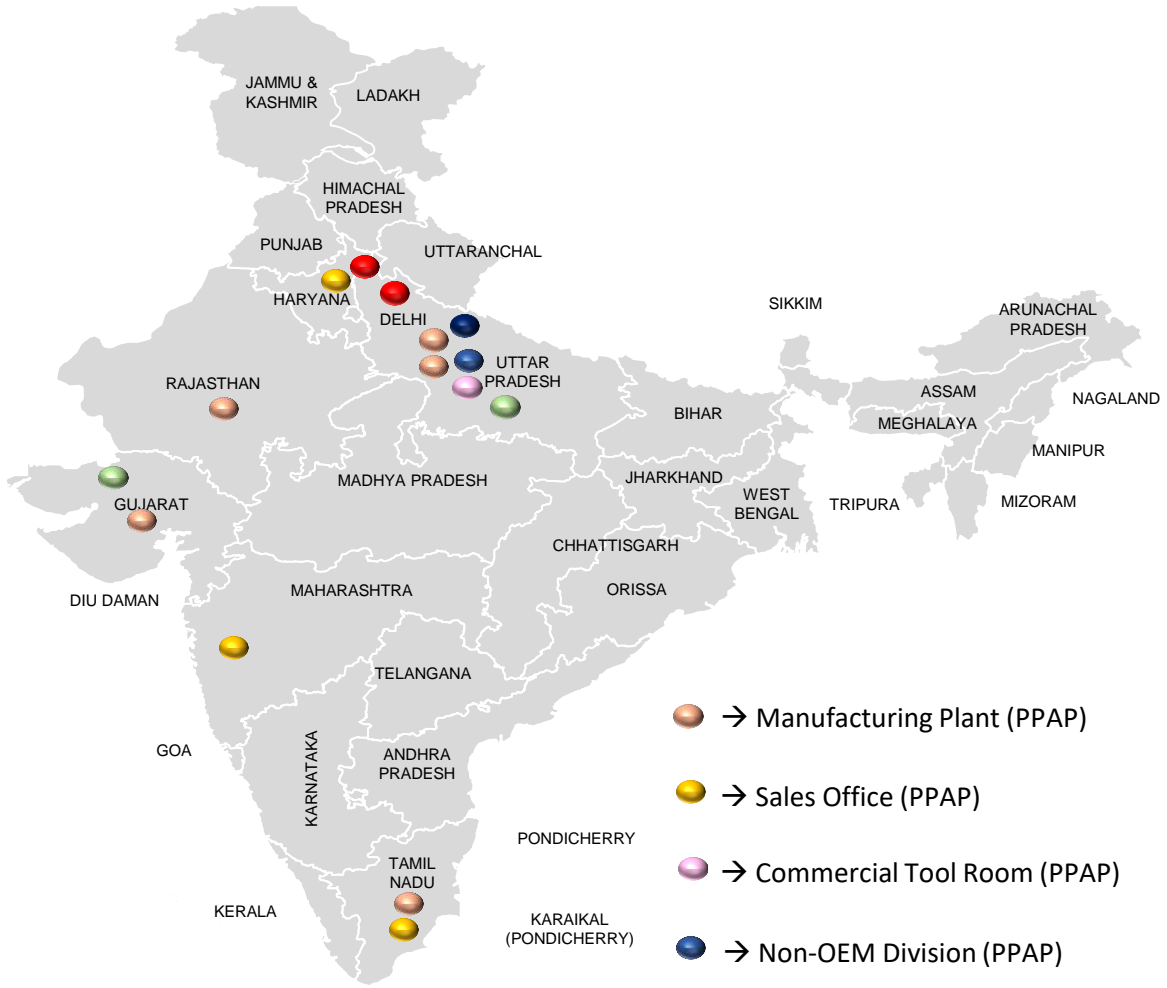

Note – Maps not to scale. All data, information, and maps are provided “as is” without warranty or any representation of accuracy, timeliness or completeness

Manufacturing Facilities...

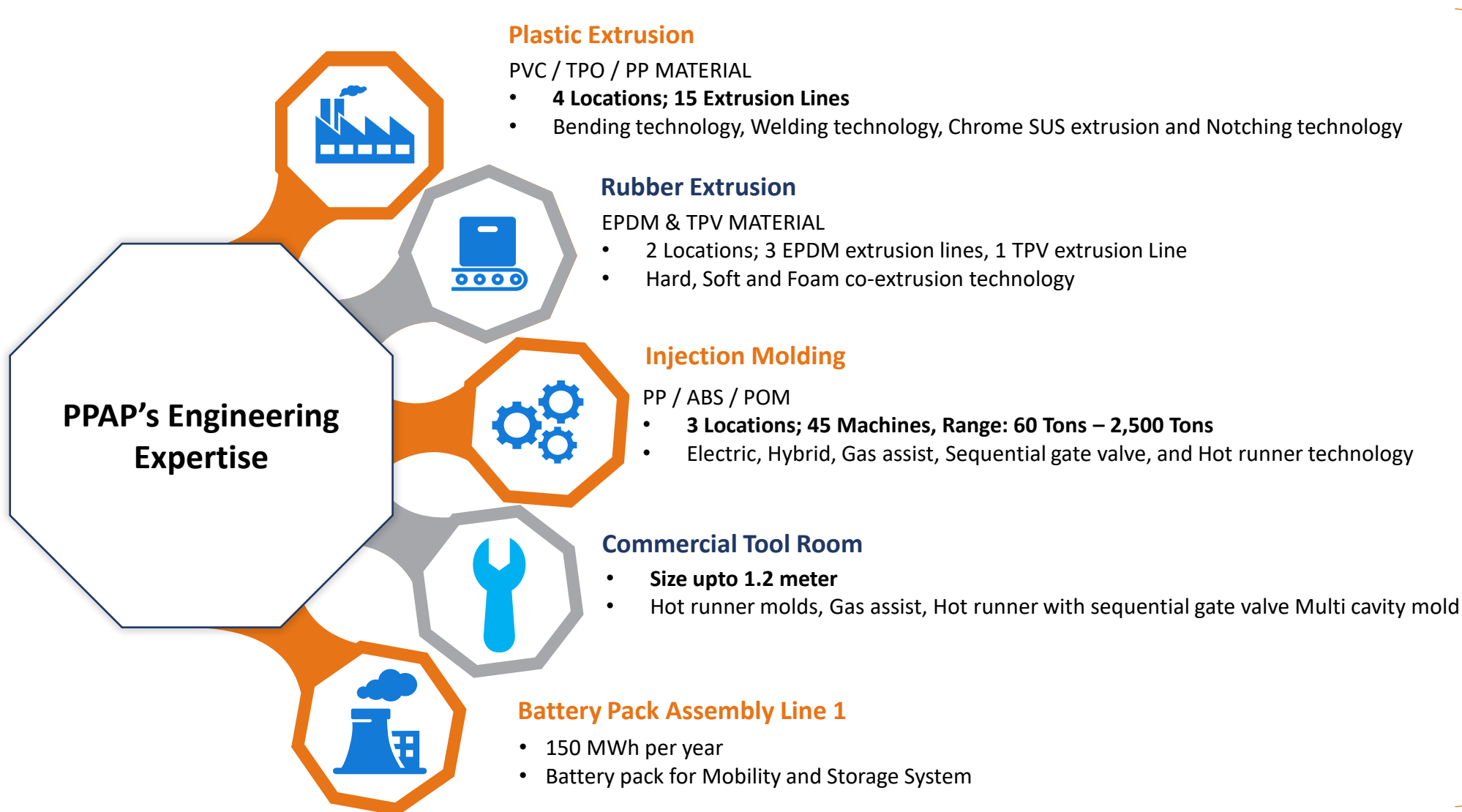

Part & Tool Design
Manufacturing
Tool
Testing & Validation

Passenger Vehicle Products

PPAP offers a diverse range of products that are applicable to both EV and non-EV vehicles

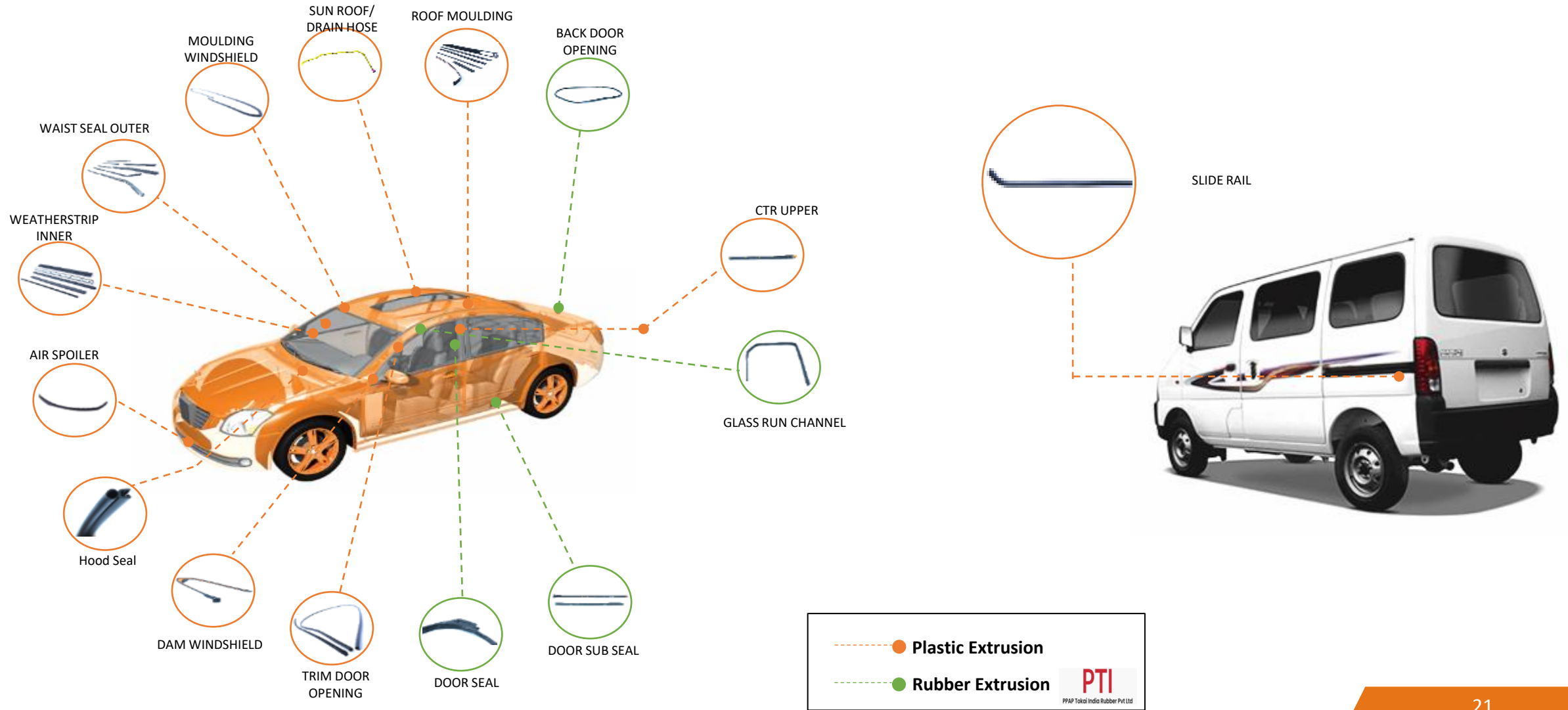

Passenger Vehicle Products

PPAP offers a diverse range of products that are applicable to both EV and non-EV vehicles



Commercial Vehicle Product



--- Injection Moulding



Two Wheeler Products



PPAP offers a diverse range of products that are applicable to both EV and non-EV vehicles



EV Components – High Growth Market

PPAP intends to manufacture a variety of electric vehicle components in order to meet the growing demand for EVs

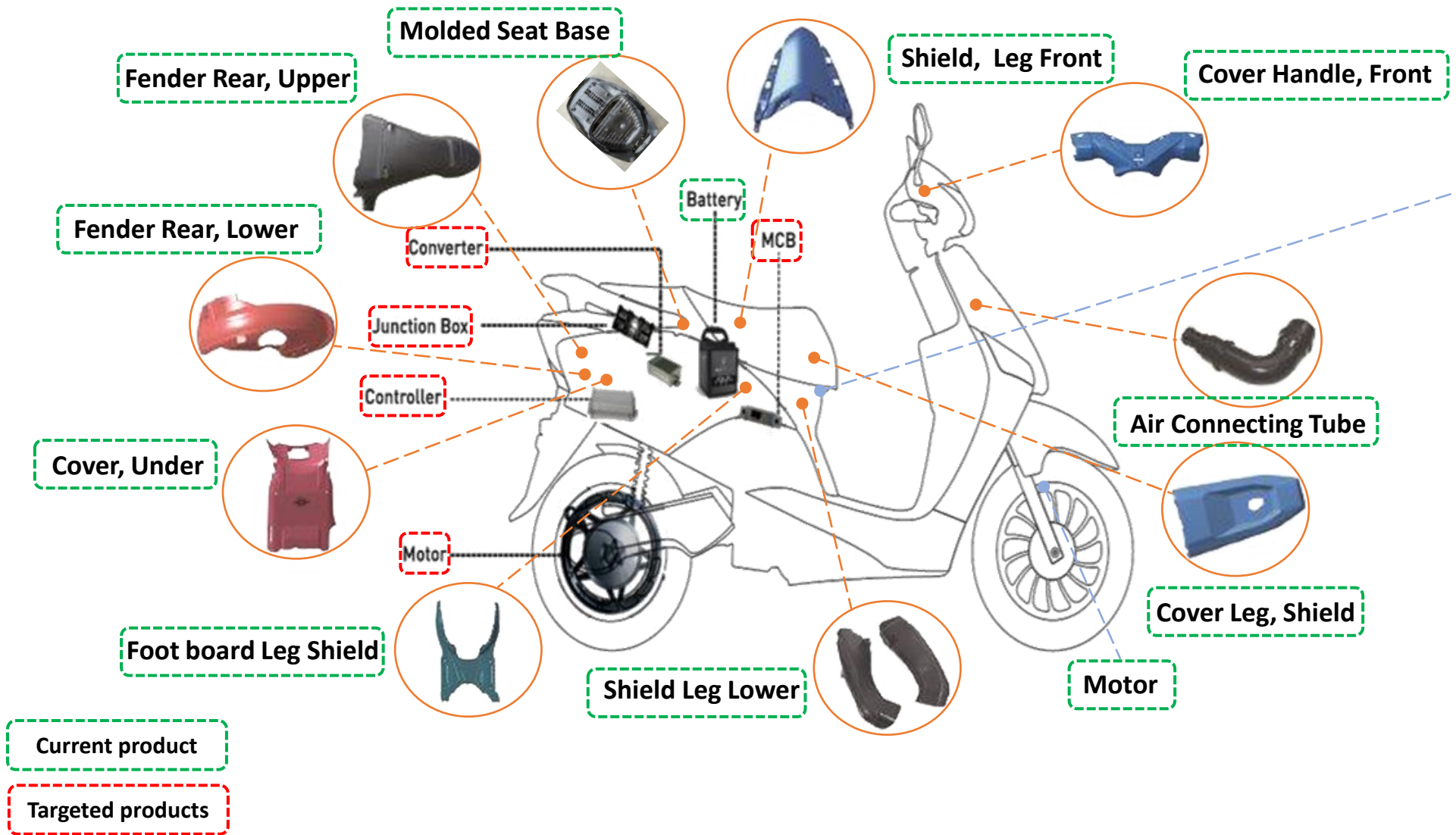

Battery Pack for Electric Vehicles



PTech
PPAP Technology Limited

Diversified Product Mix



Plastic Injection Tools

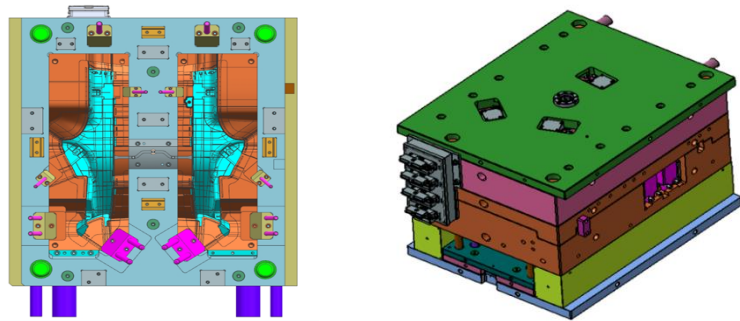
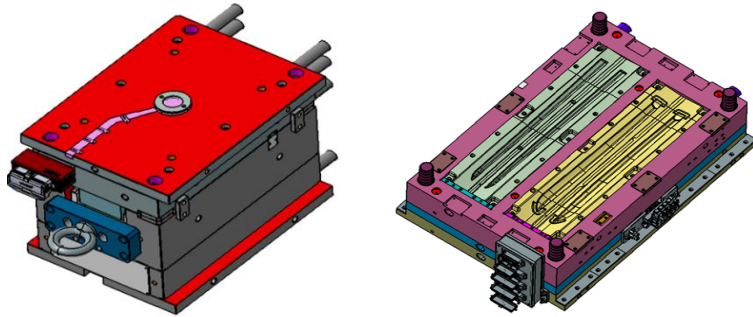

Tonnage – Upto 850 Tons
Size – 1500 (L) x 1000 (W) x 850 (H)
Mould Weight – Upto 8 Ton



Battery Pack for Back up power



Application :



Solar Street Light



Mobile Towers



UPS

The battery packs are used in multiple products for providing back up power



Pail Containers



Containers for storing fertilizers, paints and lubricants

Aftermarket – A Large Opportunity

- The Company has ventured into development of parts and accessories for aftermarket.
- The products are sold through the wholly owned subsidiary Elpis Components Distributors Private Limited
- Currently, this segment contributes 3% of revenue and is expected to increase to 10% by FY24

Distribution Network

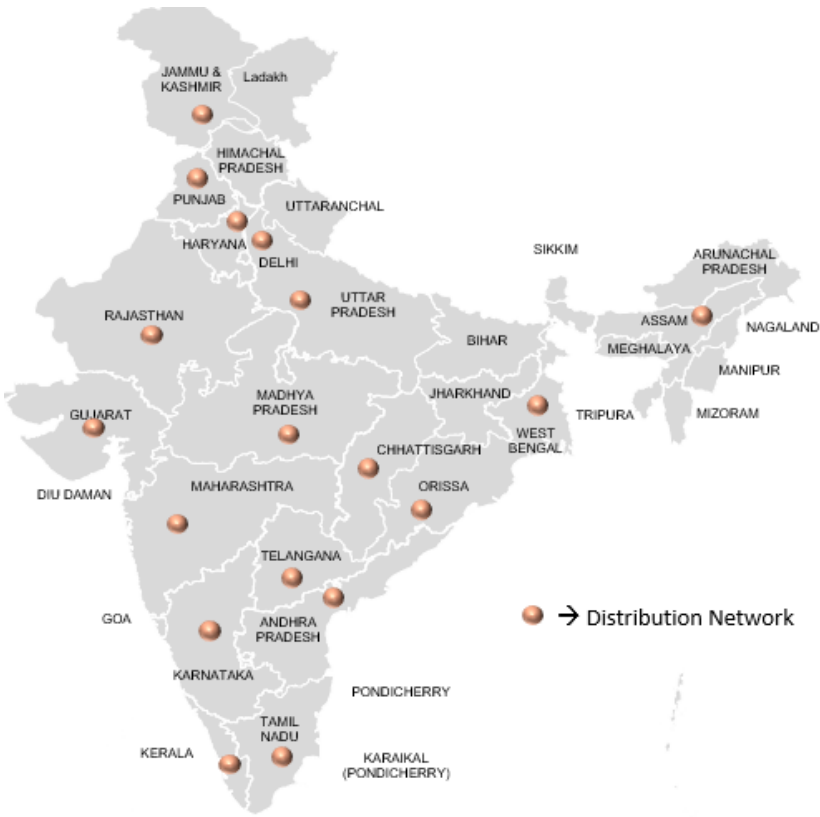

Car Accessories



- Interior accessories – Phone holder, Rear tray, charger sockets, Perfumes
- Range of cleaning products

Shopelpis.com

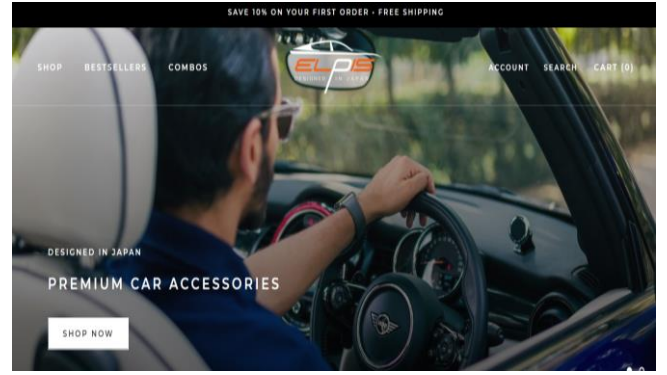

Amazon.com

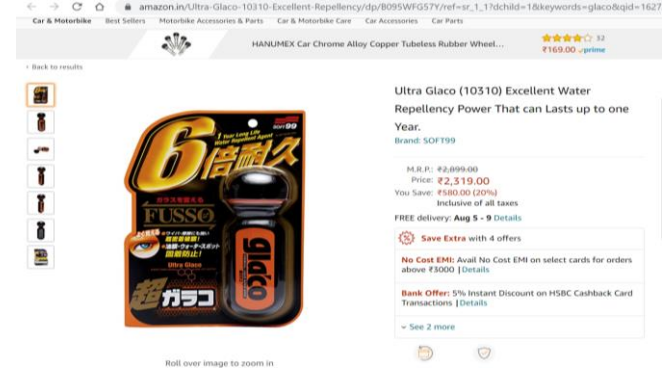

Note – Maps not to scale. All data, information, and maps are provided “as is” without warranty or any representation of accuracy, timeliness or completeness



Esteemed Clientele

Passenger Vehicle

Two Wheeler

Commercial Vehicle

Battery Packs – EV Two Wheelers

Battery Packs – Storage System

Pail Containers

Tooling

Note - The Brand Names mentioned are the property of their respective owners and are used here for identification purposes only



Growth Roadmap – Explore, Expand & Excel



Strengthen and grow Automotive Parts business

- Development of value-added parts that will command higher prices and contribute to higher margins
- Increase per car value for existing customers and continue to add new customers
- Future ready processes with manufacturing excellence and digitization

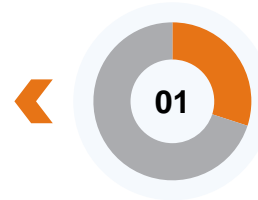

Unlocking hidden potential for tooling business

- Develop plastic injection tooling business as a profit center
- Explore opportunities in Automotive, White Goods and Electrical segments

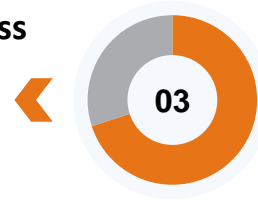

Develop product portfolio for Electric Vehicles

- Develop customers making Electric Vehicles for the existing product range (Body Sealing Products and Interior and Exterior Injection Products)
- Develop special products focusing on 2-Wheeler and 3-Wheeler requirements (like Battery Pack, motor controllers etc)

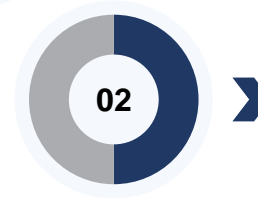
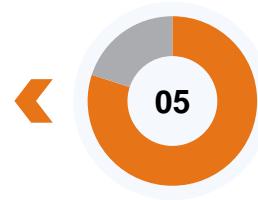

Market Place Enhancement

- Explore new market avenues for existing products
- Develop new products focusing on after market
- Develop after market customers through distribution partners and direct online sales channels

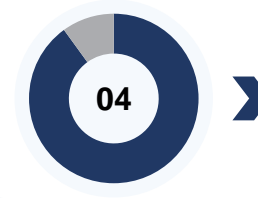

Diversification in the neighbouring industries

- Explore opportunities to promote core competence of the company in neighboring industries (Extrusion and Injection Molding)
- Develop value added products for various sectors like Packaging, Medical, Railways, Construction etc...

Why Trust PPAP... at a glance

01

Continuous improvement of operational efficiency

- Cost sensitive working culture
- International benchmarking
- Implementation of TPS & TBP (Toyota Production System & Toyota Business Practices)
- Focus on Human Development – Development of Mind, Body and Intellect
- Optimize use of resources

02

Portfolio approach to margin-rich blended product mix

- The Company has a portfolio approach to building a healthy mix of premium-priced value added products and budget-priced mould parts
- The Company's product mix is carefully blended to ensure PPAP is able to make healthy overall margins at a portfolio level

03

Organic growth complemented by adding new clients and geographies

- The Company presently caters to marquee OEMs such as Maruti Suzuki, Honda, Hyundai, Tata etc.
- Continuously explore and add new customers, while consistently expanding its per car share within the existing OEMs organically
- Developing value added products through inhouse Research and Technical Development capabilities
- Operations closer to the customer

04

Sound financials giving headroom to fund its growth

- A strong financial discipline coupled with the ability to generate regular free cash flows, allows PPAP to adequately fund its growth organically
- Low debt ratios
- Focus on improvement of return ratios
- Focus on "Every Paisa Counts"

ESG Initiatives

Environment

- PPAP is dedicated to reducing the environmental footprint through an efficient and process-oriented approach
- PPAP has been taking initiatives for reducing energy consumption and GHG emissions by installing rooftop solar and introducing various energy efficient technology
- Focus on waste management and water resource management



Social

- PPAP is committed to constantly improve employee development in the skill & talent management cycle from employment, growth and retention through training & user-friendly technology
- Promotes gender diversity and has hired women at shop floor as well as Corporate office
- CSR activities done through Vinay & Ajay Jain Foundation in the field of Environment, education and healthcare



Robust Governance Framework

Governance

- PPAPs philosophy for governance aims to achieve the highest standards of corporate governance, accountability, sustainability and compliance of all the laws in the letter and spirit
- PPAP strongly believes that effective and good corporate governance practices build a strong foundation of trust and confidence, attracting human capital, leading to sustainable and superior performance
- There are various committees that play a crucial role in the governance structure of the Company and have been constituted to deal with specific areas and activities which concern the Company
- PPAP has established a risk management framework that enables regular and active monitoring of business activities to identify, assess and mitigate potential internal or external risks
- The Company has a code of conduct for all employees, including the Board and senior management personnel. All members of the Board and Senior Management personnel have affirmed compliance with the said code of conduct





**Historical
Financials**





Standalone P&L



Particulars (INR Cr)	FY22	FY21	FY20	FY19
Revenue from operations	409.1	321.2	360.0	411.0
COGS	247.1	182.6	195.9	210.6
Gross Profit	162.0	138.5	164.1	200.4
Gross Profit Margin	39.6%	43.1%	45.6%	48.8%
Employee Expenses	69.6	61.2	66.1	71.3
Other Expenses	53.3	43.6	47.3	51.9
EBITDA	39.0	33.7	50.7	77.2
EBITDA Margin	9.5%	10.5%	14.1%	18.8%
Other Income	2.0	2.6	0.7	1.1
Depreciation	29.0	26.3	25.7	26.0
Finance Cost	6.0	3.7	2.6	4.0
Profit before Tax	6.1	6.3	23.1	48.2
Tax expenses	1.5	1.5	3.8	14.8
Profit for the year	4.6	4.8	19.3	33.4
PAT Margins	1.1%	1.5%	5.3%	8.1%
EPS	3.3	3.5	13.8	23.8

Standalone Balance sheet



Liabilities (INR Cr)	Mar-22	Mar-21	Mar-20	Mar-19
Equity				
Equity Share capital	14.0	14.0	14.0	14.0
Other Equity	298.8	295.8	290.2	281.1
Non Controlling Interest	0.0	0.0	0.0	0.0
Total Equity	312.8	309.8	304.2	295.1
Financial liabilities				
(i) Borrowings	72.4	42.3	12.0	12.9
(ii) Other Financial liabilities	0.2	0.0	0.0	0.0
Provisions	6.3	7.3	9.5	0.0
Other non current Liability	0.0	0.0	0.0	7.1
Deferred tax liabilities (Net)	7.1	7.0	7.0	9.1
Total Non Current Liabilities	86.6	56.6	28.5	29.1
Financial liabilities				
(i) Borrowings	19.4	7.3	9.9	3.8
(ii) Trade Payables	46.9	47.8	41.6	40.2
(iii) Other financial liabilities	5.8	7.7	4.2	23.8
(iv) Lease liabilities	0.5	0.0	1.0	0.0
Provisions	0.8	0.8	1.0	0.9
Other current liabilities	17.5	13.5	17.0	21.6
Current tax liabilities (Net)	0.0	0.7	0.2	0.3
Total Current Liabilities	90.9	77.8	73.8	90.6
Total Equity and Liabilities	490.3	444.2	406.5	414.8

Assets (INR Cr)	Mar-22	Mar-21	Mar-20	Mar-19
Non Current Assets				
Property, Plant and Equipment	261.4	230.6	221.7	231.2
Capital work-in-progress	20.8	20.1	7.9	0.5
Other Intangible Asset	8.8	8.9	8.5	6.0
Investment Property	1.1	0.0	0.0	0.0
Intangible assets Under Development	0.0	0.2	0.0	1.8
Right of Use Asset	1.1	0.0	0.0	0.0
Financial Assets				
(i) Investments	63.0	55.3	50.8	48.5
(ii) Loans	0.0	1.8	2.1	2.2
(iii) Other financial assets	3.7	3.0	2.4	2.6
Deferred Tax Assets (net)	0.0	0.0	0.0	0.0
Other non-current assets	10.3	11.0	8.7	4.7
Total Non Current Assets	370.2	330.6	302.0	297.6
Current Assets				
Inventories	42.9	41.8	48.8	45.0
Financial Assets				
Investments	2.7	0.0	0.0	0.0
(i) Trade receivables	52.2	61.9	41.1	57.4
(ii) Cash and cash equivalents	0.2	1.0	2.1	0.4
(iii) Other bank balances	0.1	0.1	2.9	0.1
(iv) Loans	7.5	0.5	0.4	0.4
(v) Other financial assets	1.8	0.5	0.5	4.4
Current Tax Assets(Net)	1.2	0.0	0.0	0.0
Other current assets	11.3	7.6	8.7	9.5
Total Current Assets	119.3	113.6	104.5	117.2
Total Assets	490.3	444.2	406.5	414.8



Standalone Cash Flow



Particulars (INR Cr)	Mar-22	Mar-21	Mar-20	Mar-19
Net Profit Before Tax	6.1	6.3	23.1	48.2
Adjustments for: Non Cash Items / Other Investment or Financial Items	31.5	27.0	27.8	29.8
Operating profit before working capital changes	37.6	33.3	50.9	78.0
Changes in working capital	-0.7	-2.2	-2.5	-2.4
Cash generated from Operations	36.9	31.2	48.4	75.6
Direct taxes paid (net of refund)	-3.4	-1.1	-12.2	-16.9
Net Cash from Operating Activities	33.4	30.1	36.2	58.7
Net Cash from Investing Activities	-70.2	-49.4	-29.2	-43.1
Net Cash from Financing Activities	36.0	18.3	-5.4	-16.5
Net Increase in Cash and Cash equivalents	-0.8	-1.1	1.7	-0.9
Add: Cash & Cash equivalents at the beginning of the period	1.0	2.1	0.4	1.4
Cash & Cash equivalents at the end of the period	0.2	1.0	2.1	0.4



Consolidated P&L



Particulars (INR Cr)	FY22	FY21	FY20	FY19
Revenue from operations	421.9	322.2	359.5	411.0
COGS	255.8	183.0	195.2	210.6
Gross Profit	166.1	139.2	164.3	200.4
Gross Profit Margin	39.4%	43.2%	45.7%	48.8%
Employee Expenses	72.2	62.2	66.2	71.3
Other Expenses	55.2	44.1	47.4	51.9
EBITDA	38.6	32.9	50.7	77.2
EBITDA Margin	9.1%	10.2%	14.1%	18.8%
Other Income	1.0	2.1	0.6	1.1
Depreciation	29.5	26.5	25.7	26.0
Finance Cost	6.5	3.8	2.6	4.0
Profit before Tax	0.1	3.2	22.0	48.6
Tax expenses	0.9	1.1	3.8	14.8
Profit for the year	-0.8	2.1	18.2	33.7
PAT Margins	-0.2%	0.7%	5.1%	8.2%
EPS	-0.6	1.5	13.0	24.1

Consolidated Balance sheet



Liabilities (NR Cr)	Mar-22	Mar-21	Mar-20	Mar-19
Equity				
Equity Share capital	14.0	14.0	14.0	14.0
Other Equity	289.9	292.2	289.2	281.4
Non Controlling Interest	0.0	0.0	0.0	0.0
Total Equity	303.9	306.2	303.2	295.4
Financial liabilities				
(i) Borrowings	78.9	44.6	12.0	12.9
(ii) Lease liabilities	0.9	0.0	0.0	0.0
(iii) Other Financial liabilities	0.1	0.0	0.0	0.0
Provisions	6.4	7.3	9.5	7.1
Other non current Liability	0.0	0.0	0.0	0.0
Deferred tax liabilities (Net)	6.0	6.7	7.0	9.1
Total Non Current Liabilities	92.2	58.5	28.5	29.1
Financial liabilities				
(i) Borrowings	29.2	7.6	9.9	3.8
(ii) Trade Payables	48.6	47.9	41.9	40.2
(iii) Other financial liabilities	6.4	7.9	4.3	23.8
(iv) Lease liabilities	0.8	0.0	0.0	0.0
Provisions	0.9	0.8	1.0	0.9
Other current liabilities	17.7	13.6	17.0	21.6
Current tax liabilities (Net)	0.0	0.7	0.1	0.3
Total Current Liabilities	102.7	78.5	74.1	90.6
Total Equity and Liabilities	499.5	443.2	405.8	415.1

Assets (NR Cr)	Mar-22	Mar-21	Mar-20	Mar-19
Non Current Assets				
Property, Plant and Equipment	273.9	234.9	221.7	231.2
Capital work-in-progress	20.8	20.1	8.4	0.5
Other Intangible Asset	8.8	9.0	8.5	6.0
Intangible assets Under Development	0.7	0.2	0.0	1.8
Right of Use Asset	1.6	0.0	0.0	0.0
Financial Assets				
(i) Investments	42.9	46.4	47.9	48.8
(ii) Loans	0.0	1.8	2.1	2.2
(iii) Other financial assets	5.1	3.0	2.4	2.6
Deferred Tax Assets (net)	0.0	0.0	0.0	0.0
Other non-current assets	10.3	10.7	8.7	4.7
Total Non Current Assets	364.2	326.1	299.7	297.9
Current Assets				
Inventories	56.1	45.0	49.6	45.0
Financial Assets				
Investments	2.7	0.0	0.0	0.0
(i) Trade receivables	55.9	60.4	40.0	57.4
(ii) Cash and cash equivalents	0.4	1.3	3.2	0.4
(iii) Other bank balances	0.1	0.2	2.9	0.1
(iv) Loans	0.0	0.5	0.4	0.4
(v) Other financial assets	1.8	1.7	0.5	4.4
Current Tax Assets(Net)	1.2	0.0	0.0	0.0
Other current assets	17.2	8.1	9.6	9.5
Total Current Assets	135.4	117.2	106.1	117.2
Total Assets	499.5	443.3	405.8	415.1

Consolidated Cash Flow



Particulars (INR Cr)	Mar-22	Mar-21	Mar-20	Mar-19
Net Profit Before Tax	0.1	3.2	22.0	48.2
Adjustments for: Non Cash Items / Other Investment or Financial Items	36.7	28.6	28.7	29.8
Operating profit before working capital changes	36.9	31.9	50.7	78.0
Changes in working capital	-12.3	-4.4	-2.7	-2.2
Cash generated from Operations	24.6	27.5	48.0	75.7
Direct taxes paid (net of refund)	3.6	-1.1	-12.2	-16.9
Net Cash from Operating Activities	21.0	26.4	35.9	58.8
Net Cash from Investing Activities	-70.9	-48.9	-27.5	-43.1
Net Cash from Financing Activities	41.9	20.6	-5.6	-16.6
Net Increase in Cash and Cash equivalents	-0.9	-1.9	2.8	-0.9
Add: Cash & Cash equivalents at the beginning of the period	1.3	3.2	0.4	1.4
Cash & Cash equivalents at the end of the period	0.4	1.3	3.2	0.4



For further information, please contact

Company :



CIN: L74899DL1995PLC073281

Ms. Pankhuri Agarwal
investorservice@ppapco.com

www.ppapco.in

Investor Relations Advisors :

SGA Strategic Growth Advisors

CIN: U74140MH2010PTC204285

Mr. Aakash Mehta / Mr. Rahul Agarwal
aakash.s.m@sgapl.net / rahul.agarwal@sgapl.net
+91 98706 79263 / +91 98214 38864

www.sgapl.net