

Registered Office  
"Maithri"  
132, Cathedral Road,  
Chennai 600 086, India.  
CIN: L63011TN2004PLC054948

Tel: 91 44 2811 2472  
URL: [www.ranegroup.com](http://www.ranegroup.com)

## Rane Brake Lining Limited



// Online submission //

RBL / SE / 012 / 2023-24

May 18, 2023

<b>BSE Limited</b> <b>Listing Centre</b> Scrip Code: <b>532987</b>	<b>National Stock Exchange of India Ltd.</b> <b>NEAPS</b> Symbol: <b>RBL</b>
--	--

Dear Sir / Madam,

**Sub: Earnings Presentation – Audited Financial Results for the quarter ended March 31, 2023**

**Ref: Our letter no(s). RBL/SE/009/2023-24 dated May 08, 2023 and RBL/SE/011/2023-24 dated May 12, 2023**

This is with reference to the aforementioned letters intimating Earnings Conference Call scheduled on **Friday, May 19, 2023 at 15:00 hours (IST)**, inter alia, to discuss the audited financial results for the quarter ended March 31, 2023. We enclose herewith copy of the Earnings presentation proposed to be made thereat, to the analyst and investors.

The same is also being made available on the website of the Company, [www.ranegroup.com](http://www.ranegroup.com).

We request you to take the above on record and note the compliance with SEBI (Listing Obligations and Disclosure Requirements) Regulations, 2015 (SEBI LODR).

Thanking you,

Yours faithfully,

**For Rane Brake Lining Limited**

Venkatraman  
**Secretary**

Encl: a/a



# **Rane Group**

---

Earnings Presentation | Q4 FY23

# Table of Contents



Q4 FY23 Financial & Operational Performance

Rane Group Overview



# Rane Group

## Q4FY23 Financial & Operational Performance



To become the Preferred Trusted Supplier of Safety & Critical Auto Components

## Strategic pillars of growth

---

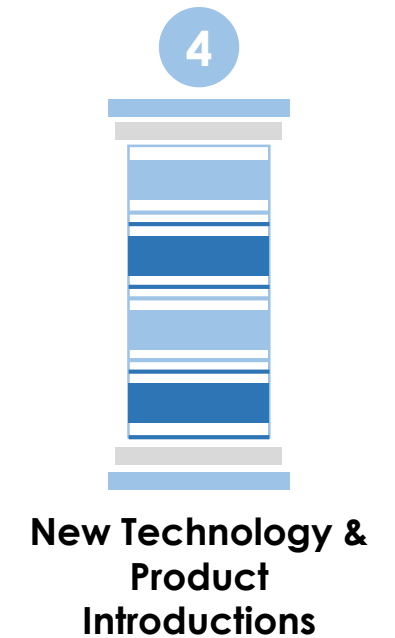
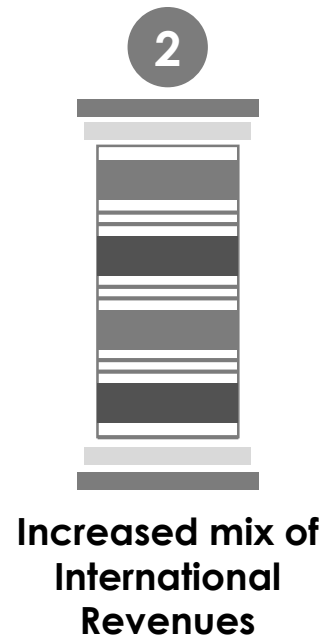

## Business Drivers

- › **93%+ of revenue comes from powertrain agnostic products**
- › **Continued dominance on domestic market across major products**
- › **Increasing export mix for steering & linkages, valve train components and occupant safety products**
- › **Renewed focus on Aftermarket segment leveraging group level synergy**
- › **Continuous introduction of new product and new technology leveraging global partnerships and strong in-house engineering capabilities**
- › **Increasing efficiencies across manufacturing facilities through operational excellence and digitalization.**

## RANE BRAKE LINING

- Won orders worth Rs. 10 Cr from various customers including EV Two Wheeler

## RANE (MADRAS)

- Won Rs. 18 Cr order for EPS for Electric LCV
- Won Rs. 70 Cr orders for steering and suspension products from various international customers
- Won Rs. 25 Cr order for R&P for an Electric PV
- Won Rs. 32 Cr orders for steering and suspension products from multiple domestic customers

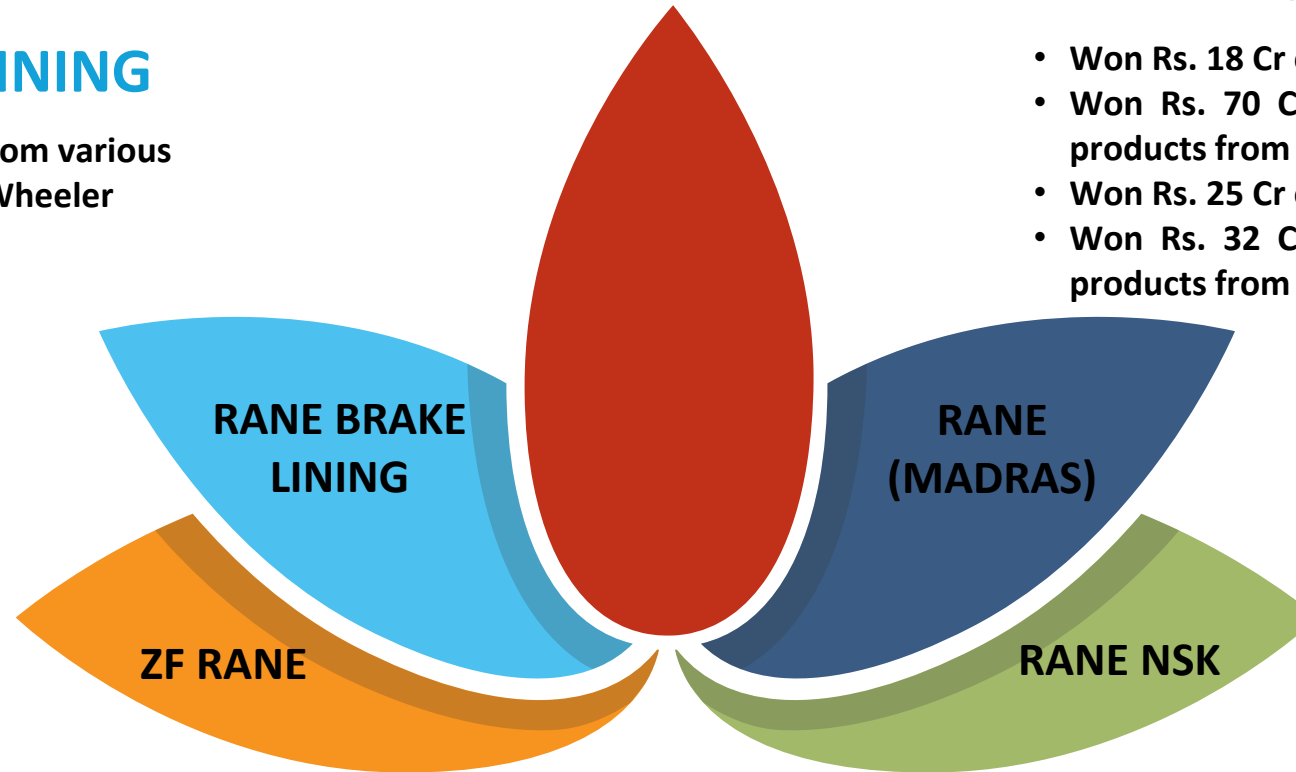





## ZF RANE

- Won orders worth Rs. 360 Cr for Occupant safety products from several domestic OE customers
- Won orders worth Rs. 30 Cr for Steering products

## RANE NSK

- Won new business worth Rs. 120 Cr for EPS from domestic customer
- Won Rs. 8 Cr orders for MSC from various domestic customers

# We continue to target higher than the industry growth

Industry Performance Review (Q4 FY23)	 Passenger Vehicle	 commercial Vehicle	 Farm Tractor	 2-Wheeler
Production YoY Growth# in %	13%	6%	35%	-3%
Rane Group Sales Growth YoY in % (India OEM)	9%	7%	66%	24%
Rane Group Revenue Split * (India OEM)	61%	28%	6%	3%
	<ul style="list-style-type: none"> <li>Lower growth than the industry due to lower growth on served models.</li> </ul>	<ul style="list-style-type: none"> <li>Higher share of business and higher growth with served models/customers</li> </ul>	<ul style="list-style-type: none"> <li>Performance is better than industry due to performance of served models</li> </ul>	<ul style="list-style-type: none"> <li>Better performance is driven by higher supplies of light metal casting products to EV segment</li> </ul>

\* Other segments such as Rail, Defence, Stationary Engines and 3-Wheeler contribute around 2%

## Market Commentary

- Strong demand Indian PV customers driven by robust booking pipeline across OEMs
- Continue to experience strong demand in the CV segment supported by infra push
- Demand from Farm Tractor segment remains moderate
- Demand from international markets remained favourable albeit there are signs of slowdown due to geo political issues and monetary tightening



# Group Aggregate Sales (Q4 FY23)

**Total Revenue (Rs cr.)**

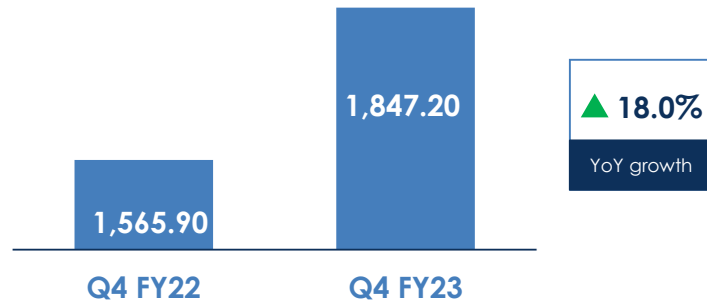

› **Total Revenue increased by 18% from Rs. 1,565.9 Cr in Q4 FY22 to Rs. 1,847.2 Cr in Q4 FY23**

- Revenue from Indian OE customers grew 10% supported by strong growth across vehicle segments
- Revenues from International customers increased 49% driven by higher off-take across steering, valve train, light metal casting and occupant safety products
- Revenue from Indian aftermarket segment grew 11%

## Group Aggregate Sales (Q4 FY23)

**BY PRODUCT (%)**

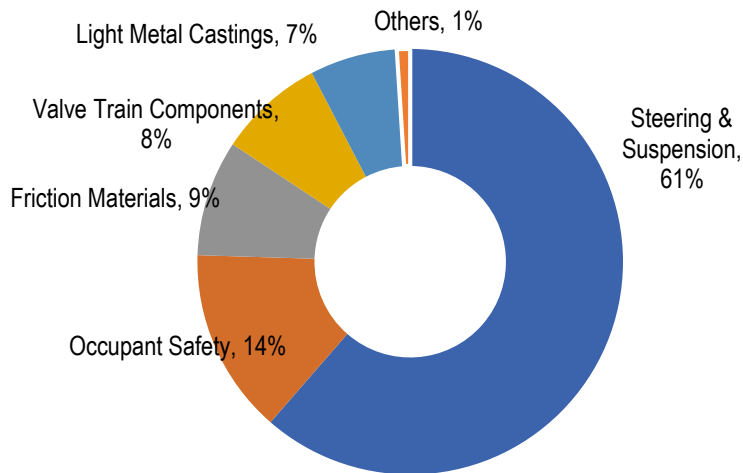

**BY MARKET (%)**

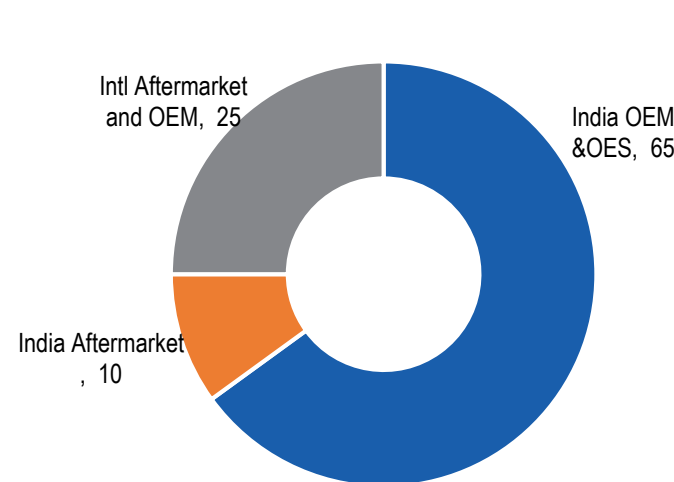

**BY VEHICLE SEGMENT (%)**

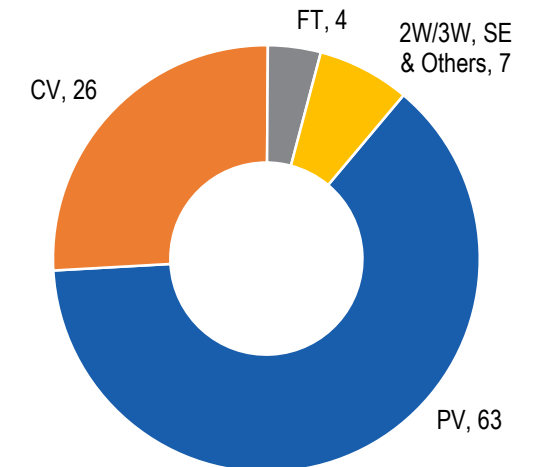

## Total Revenue (Rs cr.)

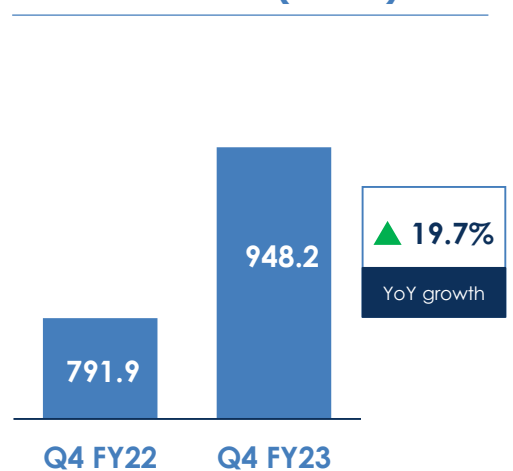

## EBITDA (Rs cr.)



## PAT (Rs cr.)

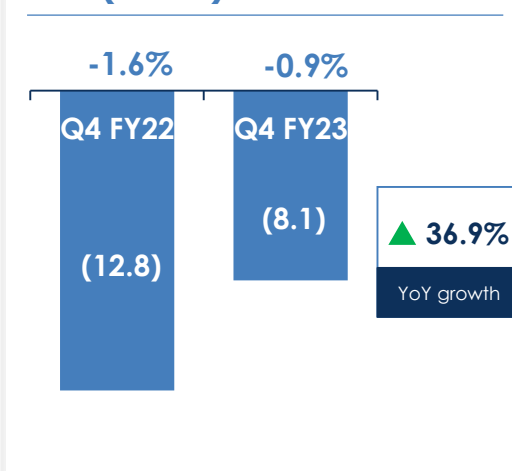

- › Total Revenue increased by 19.7% from Rs. 791.9 Cr in Q4 FY22 to Rs. 948.2 Cr in Q4 FY23
- › EBITDA increased by 54.6% from Rs. 73.9 Cr in Q4 FY22 to Rs. 114.3 Cr in Q4 FY23
- EBITDA margin increased 272 bps supported by higher volumes and improved operational performance.
- › Loss decreased by 36.9% from Rs. (12.8) Cr in Q4 FY22 to Rs. (8.1) Cr in Q4 FY23
- Exceptional expenses of Rs. 11.03 Cr in Q4 FY'23 (Rs. 0.66 Cr in Q4 FY'22) towards VRS and impairment provision

Particulars	FY' 23	FY' 22
Debt : Equity	1.06	1.01
ROCE	12.73%	4.86%
EPS (Rs.)	43.61	16.91
DPS	17.00	12.00
BV(Rs.)	565.74	544.65

# **Rane (Madras) Limited**

## **Q4 FY23 Financial & Operational Performance**

## Business Drivers

- › Strong order book pipeline for Steering and Linkages products
- › Light Metal Castings India business working on operational improvements and launching new programs to SOP in FY24

## Operational Highlights

- › The plant acquired from Yagachi Technologies was successfully transferred and integrated with Varnavasi plant
- › Several initiatives to improve OEE executed resulting in the capacity utilisation of Light Metal Castings India division improving to 72%

## Business Split (Q4 FY23) – RML India

### BY MARKET (%)

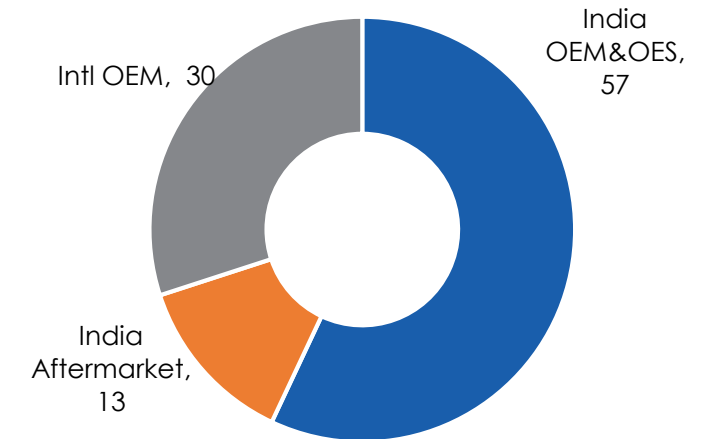

### BY VEHICLE SEGMENT (%)

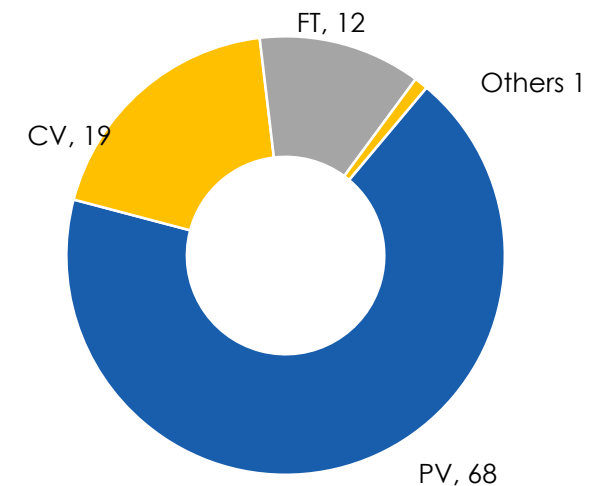

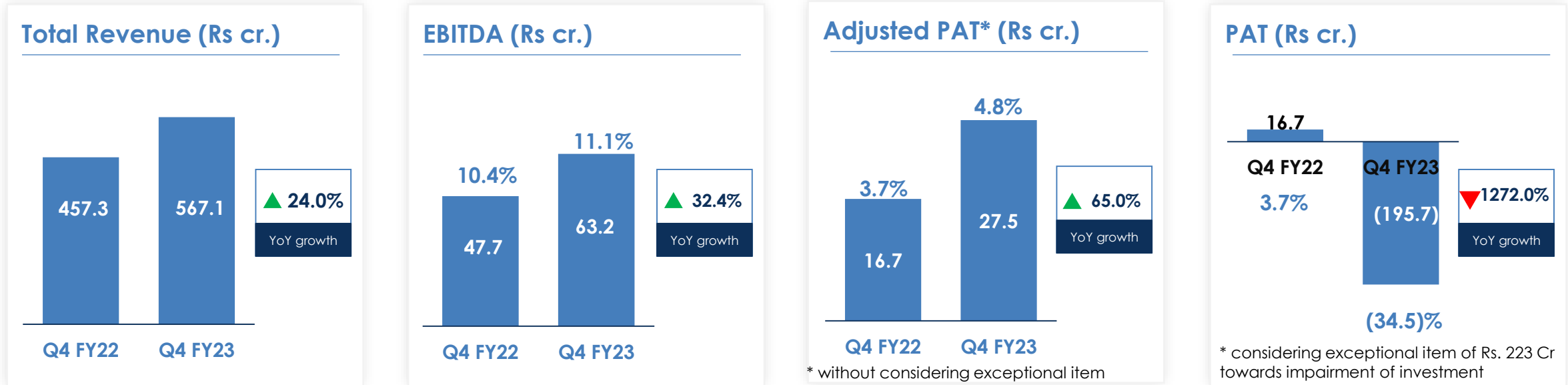

› **Total Revenue increased by 24.0% from Rs. 457.2 Cr in Q4 FY22 to Rs. 567.1 Cr in Q4 FY23**

- Sales to Indian OE customers grew 18% supported by strong demand across vehicle segments.
- Sales to International customers grew 45% driven by strong off-take for steering products.
- Sales to Indian Aftermarket customers grew 11%.

› **EBITDA increased by 32.4% from Rs. 47.7 Cr in Q4 FY22 to Rs. 63.2 Cr in Q4 FY23**

- EBITDA margin increased by 71 bps supported by better operational leverage , favourable mix performance and forex partially offset by increase in administration expenses.

› **Adjusted PAT increased by 65% from Rs. 16.7 Cr in Q4 FY22 to Rs. 27.5 Cr in Q4 FY23**

Particulars	FY' 23	FY' 22
Debt : Equity	2.12	1.19
ROCE	20.14%	8.81%
EPS (Rs.)	-77.80	23.94
BV(Rs.)	151.88	230.51

## Total Revenue (Rs cr.)

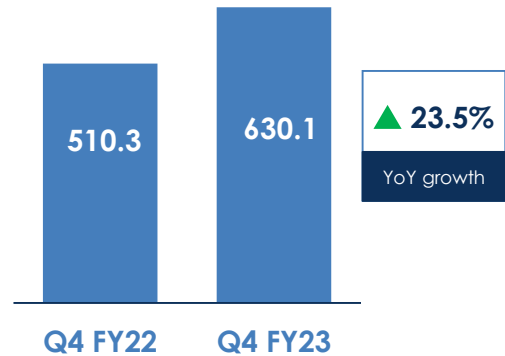

## EBITDA (Rs cr.)

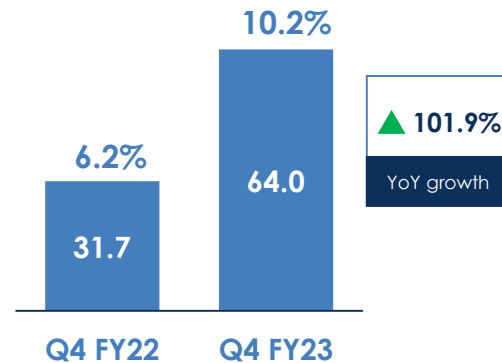

## PAT (Rs cr.)

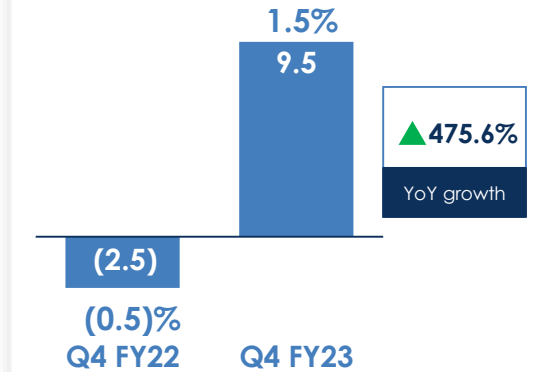

› **Total Revenue increased by 23.5% from Rs. 510.3 Cr in Q4 FY22 to Rs. 630.1 Cr in Q4 FY23**

- Sales of the US subsidiary grew with the improved off-take from customers. However the demand environment in the US remains challenging with multiple customers reducing schedules.

› **EBITDA increased by 101.9% from Rs. 31.7 Cr in Q4 FY22 to Rs. 64.0 Cr in Q4 FY23**

- Better operational performance and higher volumes helped improve profitability

› **PAT increased by 475.6% from loss of Rs. (2.5) Cr in Q4 FY22 to profit of Rs. 9.5 Cr in Q4 FY23**

- Exceptional expenses of Rs. 9.05 Cr in Q4 FY'23 (Nil in Q4 FY'22) towards impairment



Particulars	FY' 23	FY' 22
Debt : Equity	2.72	2.52
ROCE	11.53%	-0.19%
EPS (Rs.)	18.46	6.97
BV(Rs.)	148.52	140.26



# **Rane Engine Valve Limited**

**Q4 FY23 Financial & Operational Performance**

## Business Drivers

- › 44% of revenue generated from EV insulated segment
- › Sustaining financial turnaround through
  - › Higher capacity realization and new business ramp up
  - › Increasing mix of exports and EV insulated segment
  - › Operational performance improvement

## Operational Highlights

- › The capacity utilization in all the plants improved significantly and helped to meet the increased demands across vehicle segments
- › Increased focus on productivity and quality improvements yielded desired results
- › Working with customers on several projects including Hydrogen as a fuel for IC engines

### Business Split (Q4 FY23)

#### BY MARKET (%)

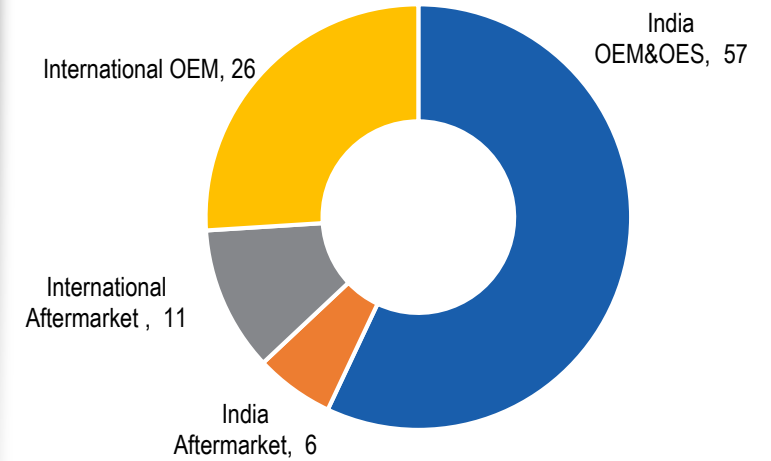

#### BY VEHICLE SEGMENT (%)

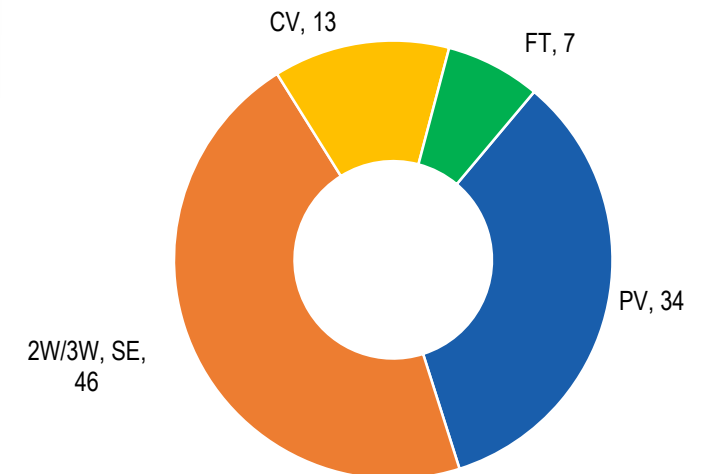

## Total Revenue (Rs cr.)

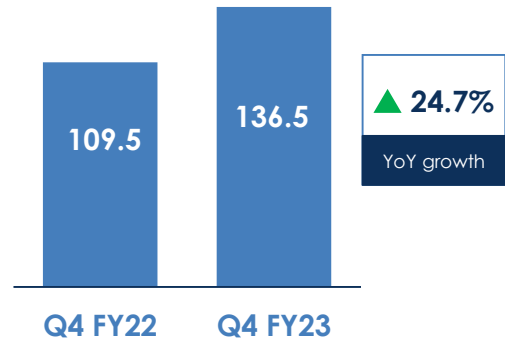

## EBITDA (Rs cr.)

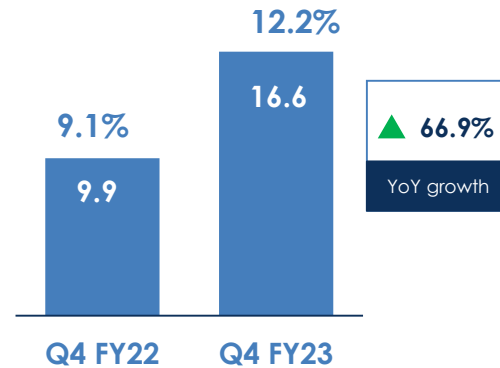

## PAT (Rs cr.)

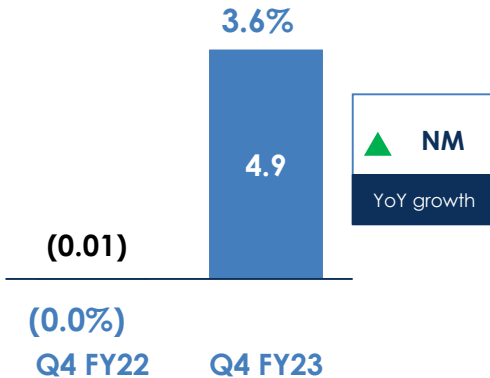

› **Total Revenue increased by 24.7% from Rs. 109.5 Cr in Q4 FY22 to Rs. 136.5 Cr in Q4 FY23**

- Sales to Indian OE customers grew 28% supported by strong offtake from Passenger vehicles and commercial vehicles customers.
- Export Sales grew 27%. Demand from International customers remained strong.
- Sales to Indian Aftermarket customers stood in-line with Q4FY'22.

› **EBITDA increased by 66.9% from Rs. 9.9 Cr in Q4 FY22 to Rs. 16.6 Cr in Q4 FY23**

- EBITDA margin improved by 307 bps due to better capacity realization through productivity improvements and operational leverage benefits.

› **PAT increased from a Loss of Rs. (0.01) Cr in Q4 FY22 to a profit of Rs. 4.9 Cr in Q4 FY23**

- Exceptional expenses of Rs. 1.99 Cr in Q4 FY'23 (Nil in Q4 FY'22) towards Warranty provision

Particulars	FY' 23	FY' 22
Debt : Equity	1.30	1.33
ROCE	8.10%	-3.17%
EPS (Rs.)	-0.09	-17.65
BV(Rs.)	148.47	144.60



# **Rane Brake Lining Limited**

## **Q4 FY23 Financial & Operational Performance**

## Business Drivers

- › Market leader in Passenger Vehicle segment and increased penetration in two wheeler segment
- › Dominant presence in Aftermarket segment, which accounts for 42% of sales
- › Expanding International Aftermarket business

## Operational Highlights

- › Installed 1MW solar plant at Hyderabad Plant
- › Won Overall Performance Award from Endurance Technologies
- › Won Gold awards under two different categories from ACMA
  - Excellence in Manufacturing, New Product & Localization
  - Excellence in Health, Safety & Sustainability

### Business Split (Q4 FY23)

#### BY MARKET (%)

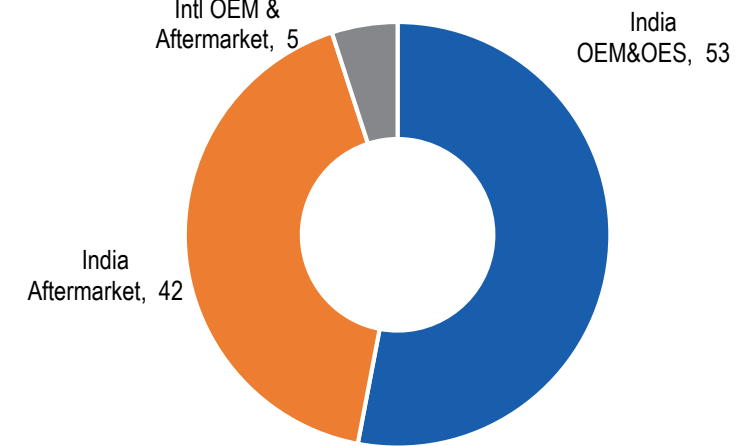

#### BY VEHICLE SEGMENT (%)

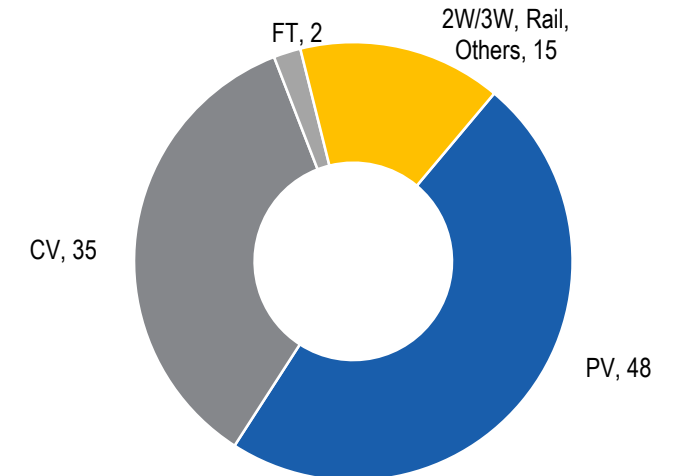

## Total Revenue (Rs cr.)



## EBITDA (Rs cr.)

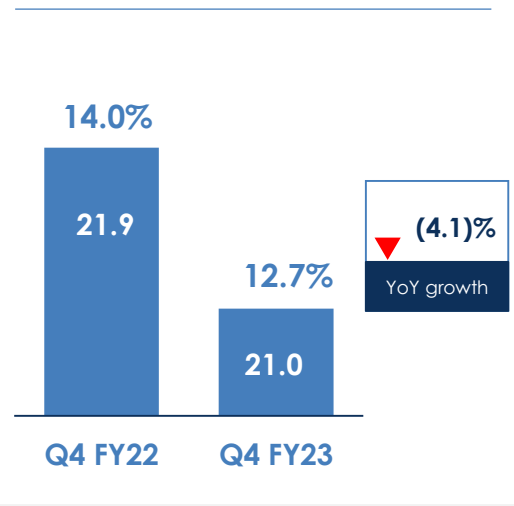

## PAT (Rs cr.)

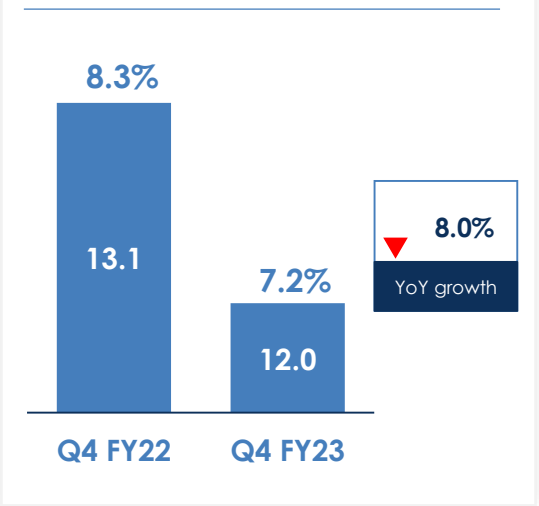

› **Total Revenue increased by 5.7% from Rs. 157.0 Cr in Q4 FY22 to Rs. 165.8 Cr in Q4 FY23**

- Sales to OE customer grew 3%, though the demand remain strong there was slightly slower growth due to inventory correction at the customer level
- Sales to Aftermarket customers grew 14%

› **EBITDA decreased by 4.1% from Rs. 21.9 Cr in Q4 FY22 to Rs. 21.0 Cr in Q4 FY23**

- EBITDA margin decreased by 128 bps due to unfavourable forex and increase in other expenses towards specific initiatives taken up during the quarter towards Energy and yield improvement projects.

› **PAT decreased by 8.0% from Rs. 13.1 Cr in Q4 FY22 to Rs. 12.0 Cr in Q4 FY23**



Particulars	FY' 23	FY' 22
Debt : Equity	-	-
ROCE	17.07%	14.30%
EPS (Rs.)	43.29	35.03
DPS	25.00	20.00
Dividend payout (%)	58%	57%
BV(Rs.)	337.88	314.16



# **ZF Rane Automotive India Private Limited**

## **Q4 FY23 Financial & Operational Performance**

## Business Drivers

- › Market upcycle in commercial vehicle segment aids growth in steering division
- › Occupant safety division benefits from evolving safety regulation in India
- › Approved under PLI scheme for localisation of inflator and webbing

## Operational Highlights

- › Bagged award from Daimler for being the reliable partner and achieving 100% delivery

### Business Split (Q4 FY23)

#### BY MARKET (%)

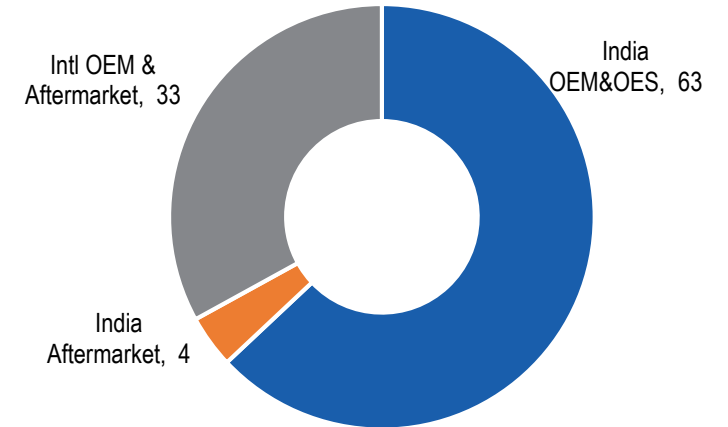

#### BY VEHICLE SEGMENT (%)

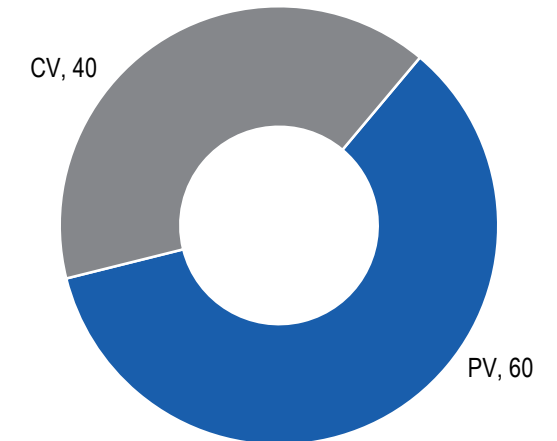

## Total Revenue (Rs cr.)

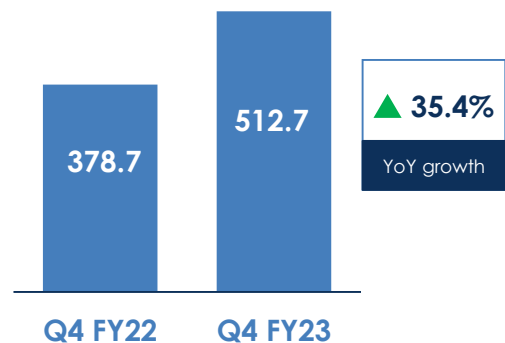

## EBITDA (Rs cr.)

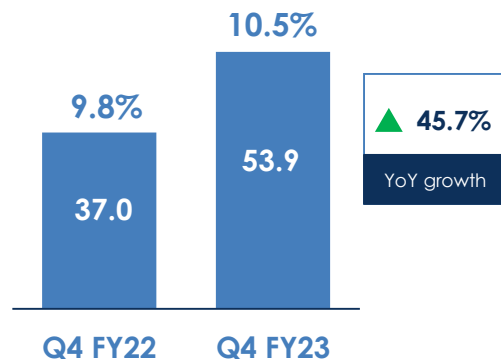

## PAT (Rs cr.)

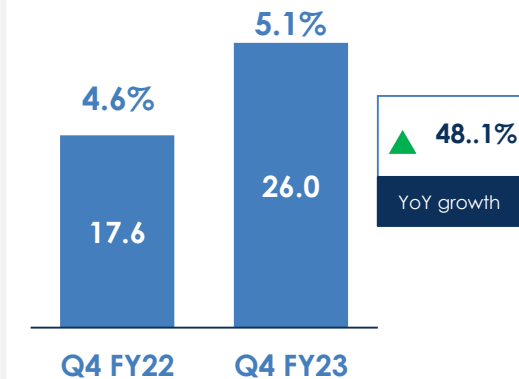

› **Total Revenue increased by 35.4% from Rs. 378.7 Cr in Q4 FY22 to Rs. 512.7 Cr in Q4 FY23**

- Revenue from steering gear products increased 18% supported by strong demand from commercial vehicle segment
- Revenue from occupant safety systems grew 57% supported by strong offtake on domestic served customers and export customers

› **EBITDA increased by 45.7% from Rs. 37.0 Cr in Q4 FY22 to Rs. 53.9 Cr in Q4 FY23**

- EBITDA margin improved by 75 bps supported by higher volumes

› **PAT increased by 48.1% from Rs. 17.6 Cr in Q4 FY22 to Rs. 26.0 Cr in Q4 FY23**

Particulars	FY' 23	FY' 22
Debt : Equity	0.65	0.43
ROCE	17.48%	11.40%
EPS (Rs.)	111.27	56.52
DPS	77.00	39.00
Dividend payout (%)	70%	69%
BV(Rs.)	563.04	492.06



# **Rane NSK Steering Systems Private Limited**

## **Q4FY23 Financial & Operational Performance**

## Business Drivers

- › Favourable share of business with key customer
- › Strong growth for Manual Steering Column product with new product introductions

## Operational Highlights

- › Awarded the Best Technology Support by Daimler India Commercial Vehicle
- › Won the Certificate of Appreciation for Excellence in Sustainable Business from ACMA.

## Business Split (Q4 FY23)

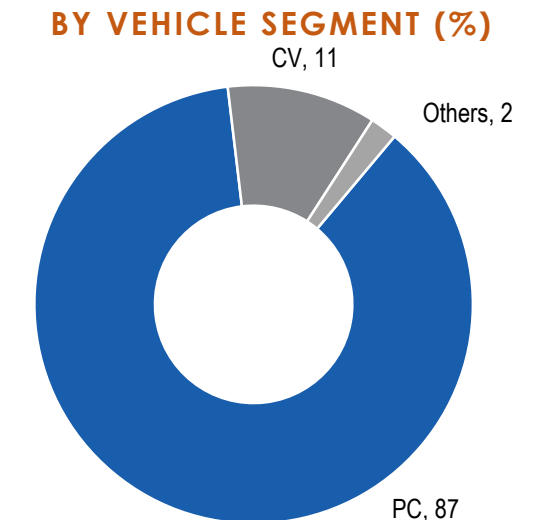
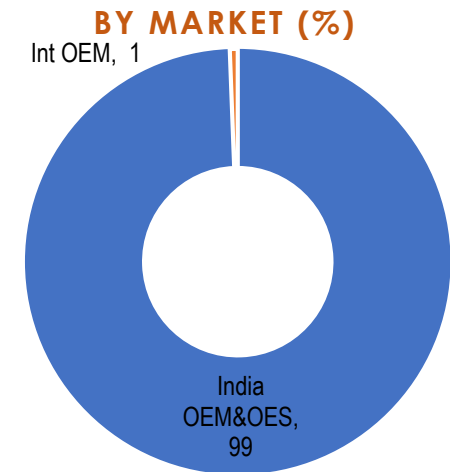

## Total Revenue (Rs cr.)

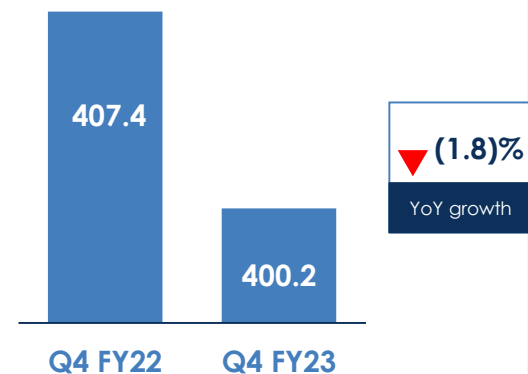

## EBITDA (Rs cr.)

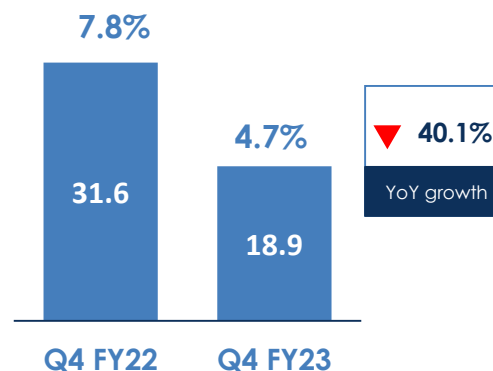

## PAT (Rs cr.)

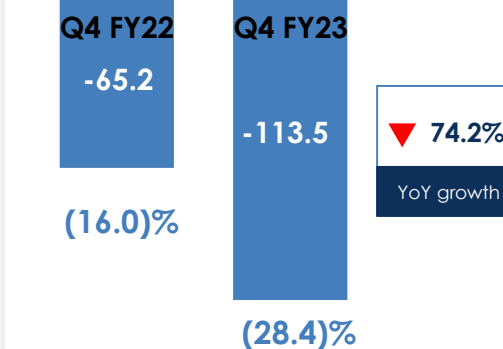

- › **Total Revenue decreased by 1.8% from Rs. 407.4 Cr in Q4 FY22 to Rs. 400.2 Cr in Q4 FY23**
  - Manual steering column business benefitted on account of upcycle in the CV segment
  - EPS business faced slower demand on served models due to semiconductor shortage
- › **EBITDA decreased by 40.1% from Rs. 31.6 Cr in Q4 FY22 to Rs. 18.9 Cr in Q4 FY23**
  - Adverse mix and increase in material cost impacted the profitability
- › **Loss increased by 74.2% from Rs. 65.2 Cr in Q4 FY22 to Rs. 113.5 Cr in Q4 FY23**
  - Exceptional expenses of Rs. 74 Cr in Q4 FY'23 (Rs. 116 Cr in Q4 FY'22)



Particulars	FY' 23	FY' 22
Debt : Equity	92.16	1.59
ROCE	18.11%	42.58%
EPS (Rs.)	-55.37	-36.34
BV(Rs.)	1.86	57.32



# Rane Group

## About Us



Founded in 1929 and headquartered in Chennai, Rane Group is one of the preferred OE manufacturer and supplier for global auto majors



The Group serves a variety of industry segments: Passenger Vehicles, Commercial Vehicles, Farm Tractors, Two-wheelers, Three-wheelers, Railways and Stationary Engines



Manufactures Steering and Suspension systems, Friction materials, Valve train components, Occupant safety systems, Light metal casting products and provide Connected mobility solutions.

REVENUE BY MARKET (%)

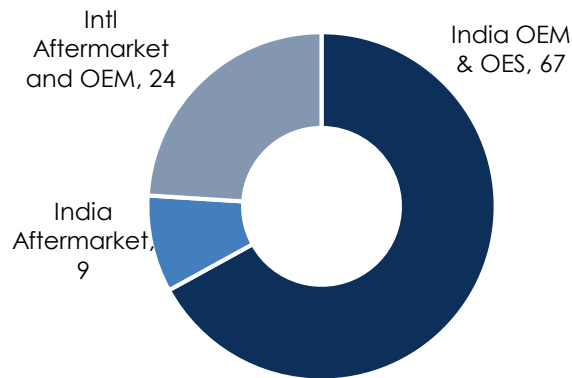

REVENUE BY VEHICLE SEGMENT (%)

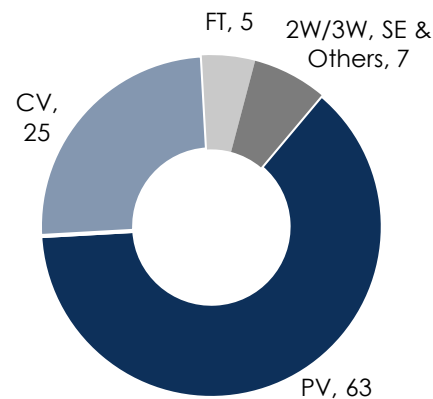

## GROUP SALES OF INR 6,690 CR (~USD 820 MN)

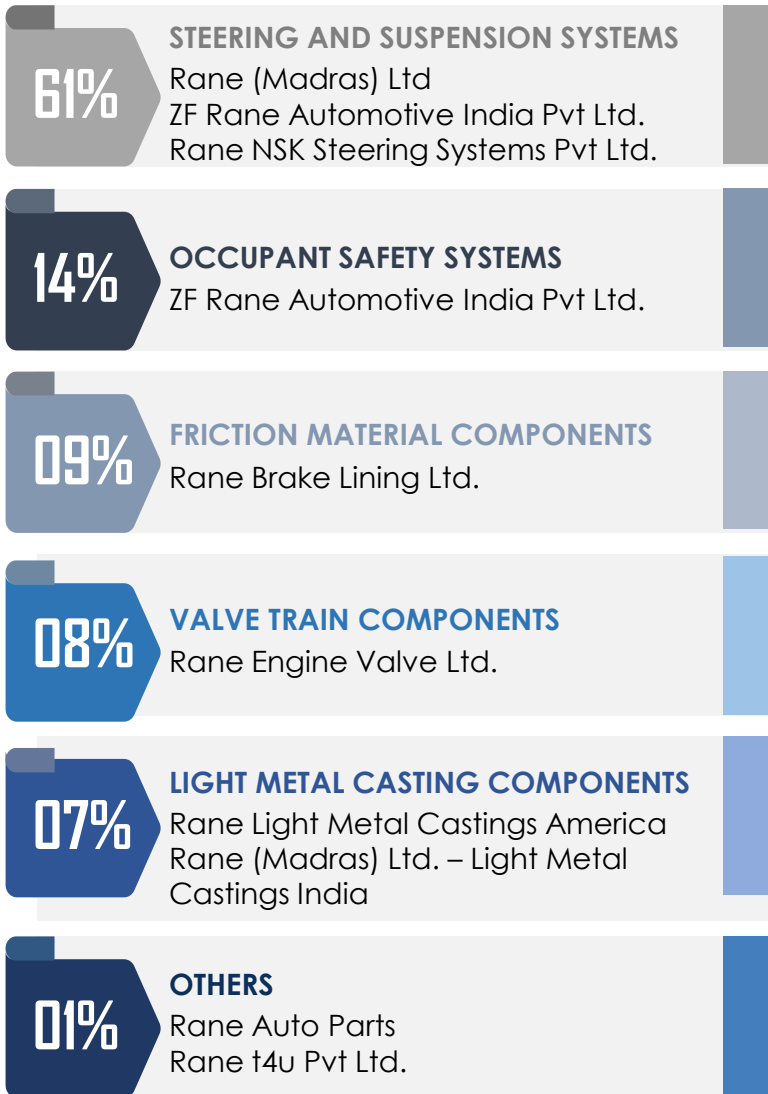

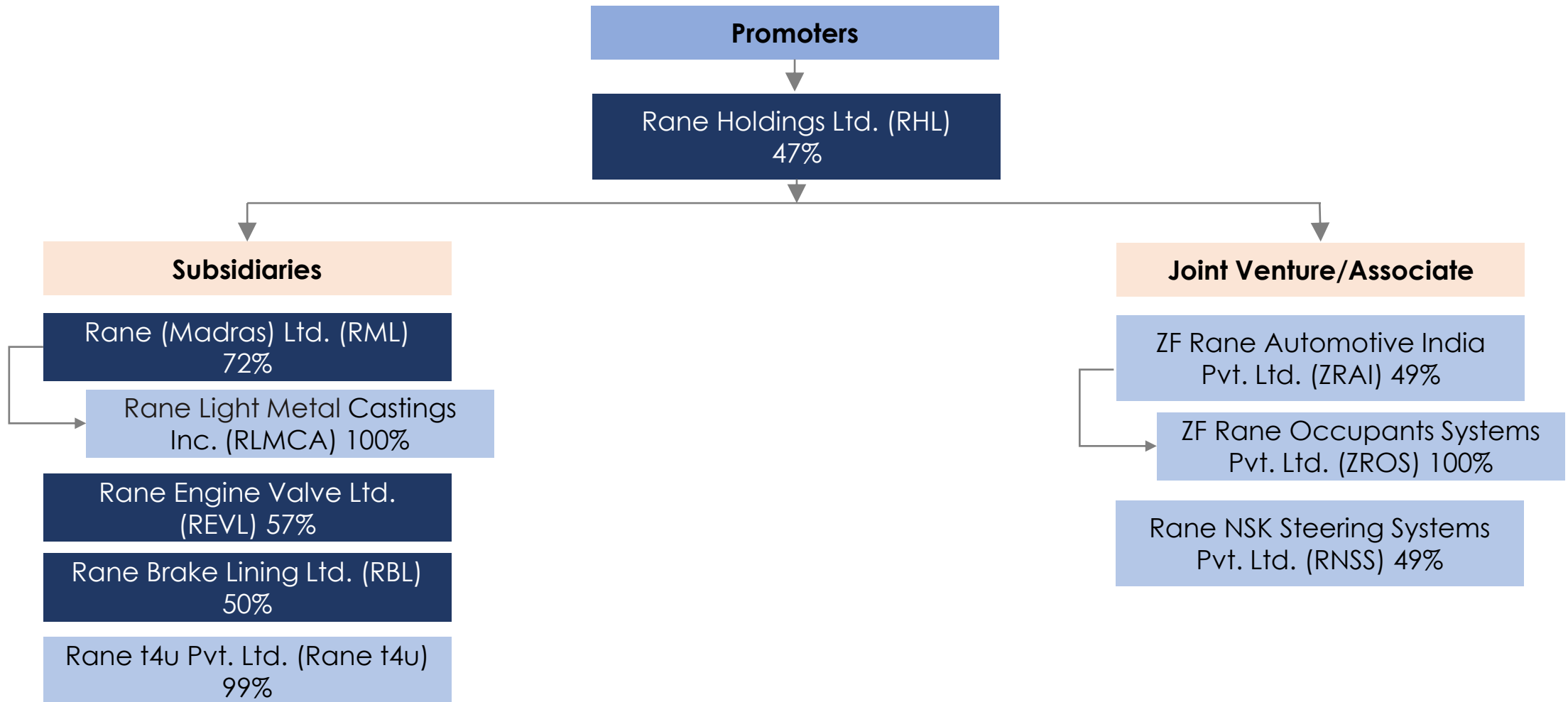



















 Listed

Share holding as on 31 March 2023

- Market leader in steering gear and steering linkage products in India. We have started catering to hydraulic products such as HSU and steering cylinders.
- Best in class manufacturing facilities at Chennai, Mysore, Puducherry and Pant Nagar.
- End to end testing facilities in house to validate the products' functional, endurance and environmental parameters.

## PRODUCTS

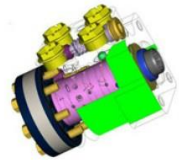
Steering and Linkage Business	Light Metal Castings India Business	Light Metal Castings AMERICA Business
 Manual Steering Gears   Suspension Components	 Hydraulic Pinion Housings   Pump Housings   EPAS – Pinion & Outboard Housings   Luminaries   Timing-Case Cover   Engine Oil Sump   Gear Case   Brake Housing   Battery Housing   Transmission Housing	 Hydraulic – Pinion Housing   Outboard Housing   EPAS – Pinion Housing   HVAC Applications   Valve Housing
 Steering Linkages   Hydraulic Products		

## MANUFACTURING PLANT

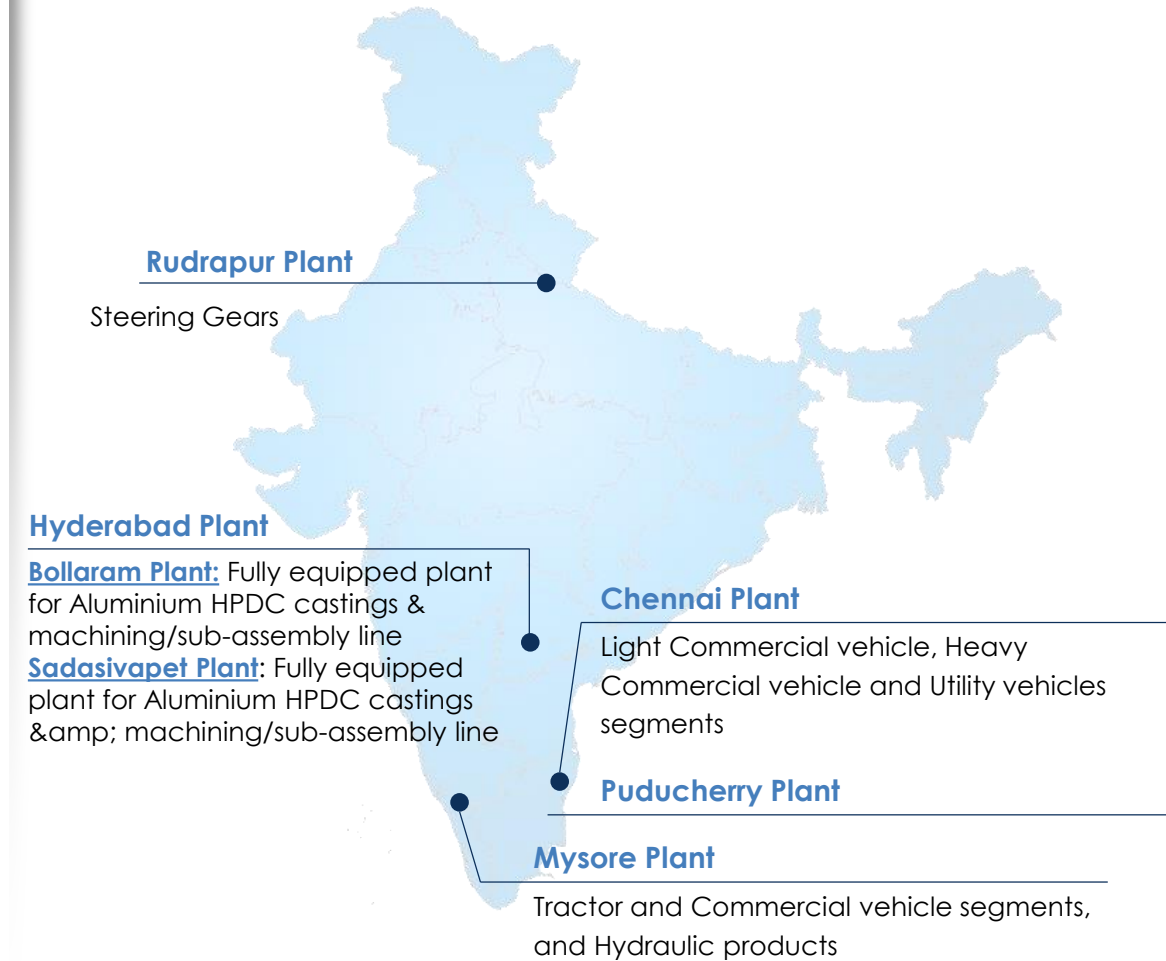

**Rudrapur Plant**  
Steering Gears

**Hyderabad Plant**  
**Bollaram Plant:** Fully equipped plant for Aluminium HPDC castings & machining/sub-assembly line  
**Sadasivapet Plant:** Fully equipped plant for Aluminium HPDC castings & machining/sub-assembly line

**Chennai Plant**  
Light Commercial vehicle, Heavy Commercial vehicle and Utility vehicles segments

**Puducherry Plant**

**Mysore Plant**  
Tractor and Commercial vehicle segments, and Hydraulic products

- Incepted In 1959, REVL manufactures valves and valve train components for various engine applications
- Non Automotive applications such as power generation, marine, defence, locomotive, etc.
- Comprehensive test laboratory for material characterisation, simulated test rigs and engine dynamometer test facility.

## PRODUCTS

Engine Valves



Valve Guides



Mechanical Tappets



## MANUFACTURING PLANT



### Hyderabad Plants (2)

Small Valves for 2W and PC  
Medium Valves for PC, Industrial and CV

### Tumakuru Plant

Medium Valves for CV and Farm Tractors  
Large & Extra Large Valves for Industrial, Power Generation and Marine Applications

### Chennai Plant

Small Valves for 2W and PC  
Medium Valves for Tractors and PC Guides, Tappets

### Trichy Plant

Small & medium Valves for 2W, PC and CV

- Established in 1964, RBL is a leader in Friction Products across OEM segments and supplies products to over 15 countries
- Technical collaboration with Nisshinbo Brakes Inc. and TMD Friction
- Library of widely tested and approved formulations to suit diverse market / customer requirements.
- State-of-the-art R&D center equipped with full scale inertia dynamometer, static mu-measurement and NVH study rig.

## PRODUCTS

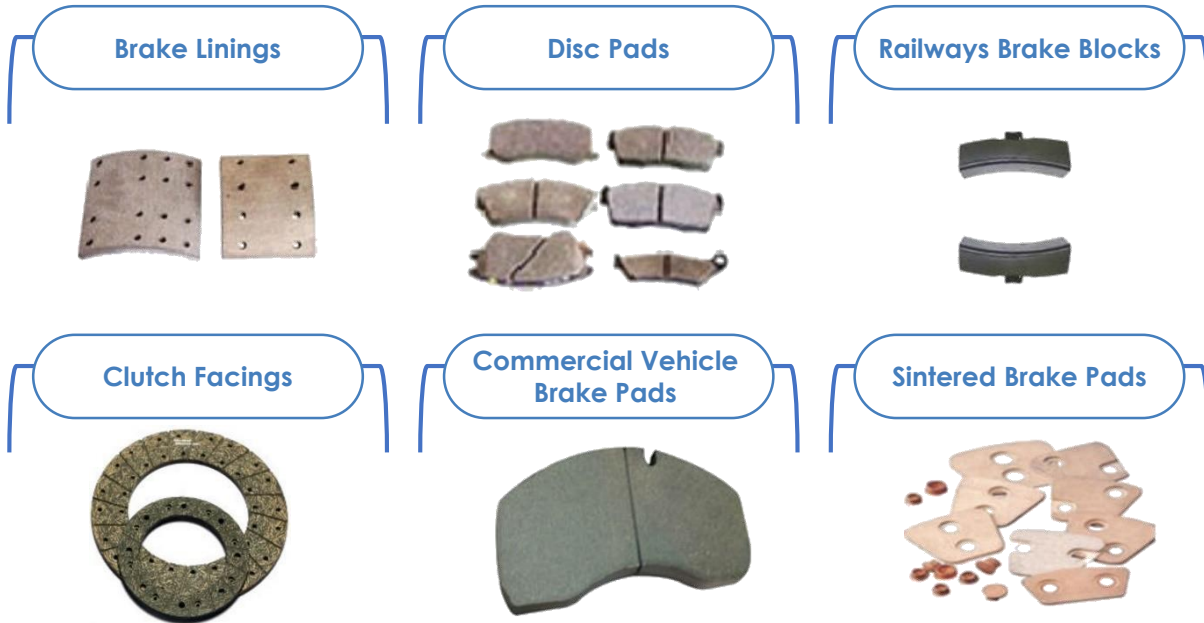

## MANUFACTURING PLANT

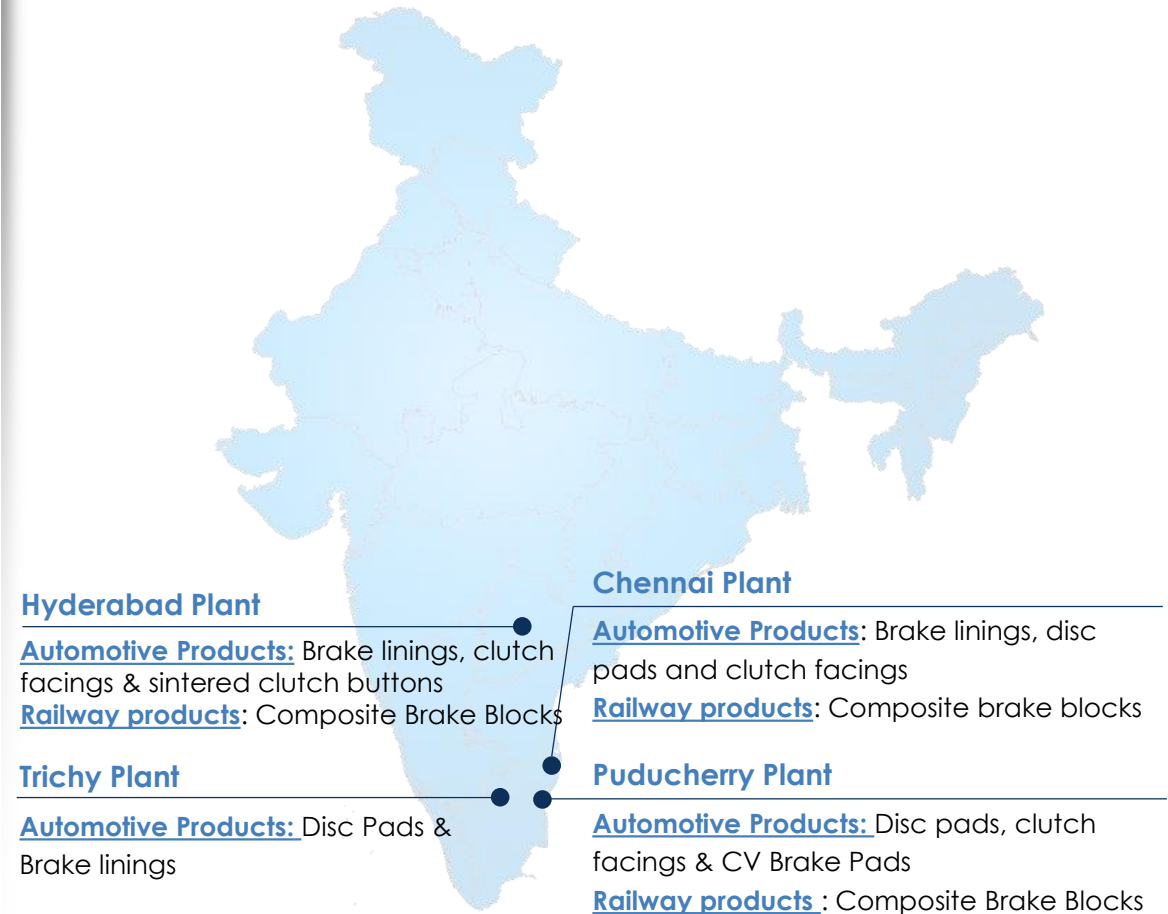

Joint venture partnership with ZF Group, Germany.

## Steering Gear Division

- Design, Development and Application capability for complete Hydraulic Power Steering system for all vehicles.
- Advanced design tools for 3D modeling, simulation, FE analysis and CFD.
- State-of-the-art testing facilities for strength, environment, noise, fatigue and durability tests to meet global standards

## Occupant Safety Division

- Product range includes different types of airbags and latest seatbelt technologies, Retractor and Anchor pretensioners, Emergency Locking Retractor (ELR), Load Limiters, Child Restraint Seat Belt, Driver Airbag, Passenger Airbag, Side Airbag and Curtain Airbags.
- Extensive testing facilities for seat belts include Extraction and Retraction Force Testing Machine, Retractor Durability Tester, Hot & Cold Chamber, Salt spray chamber, ELR functional tester.
- Equipped with Test lab to carry out testing as per National (IS/AIS), International (ECE/EEC/GS/VSCC), customer specifications and COP testing

## PRODUCTS

### Steering Gear Division



### Occupant Safety Division



## MANUFACTURING PLANT

### Rudrapur Plant

Steering Gears and Pumps

### Chennai Plant (3)

Pump and Power Rack & Pinion division, Occupant Safety Products

### Tiruchirapally Plant (2)

Fully integrated gear, Occupant Safety Products



- Joint venture partnership with NSK, Japan.
- State-of-art R&D test lab for validation of steering columns.
- Manufacturing facilities across four locations in Chennai, Bawal, Rudrapur & Ahmedabad.
- Design & Development capability for solid & energy absorbing columns. Development and application capability for EPS.
- Driver comfort, Passenger safety, Ergonomics and NVH requirements are kept as targets while designing steering system.
- Comprehensive test laboratory for extensive research about column performance characteristic validation, strength and durability validation and NVH requirements.
- Design team includes CAD & CAM application experts and software analysts.

## ▶▶▶ PRODUCTS



## MANUFACTURING PLANT

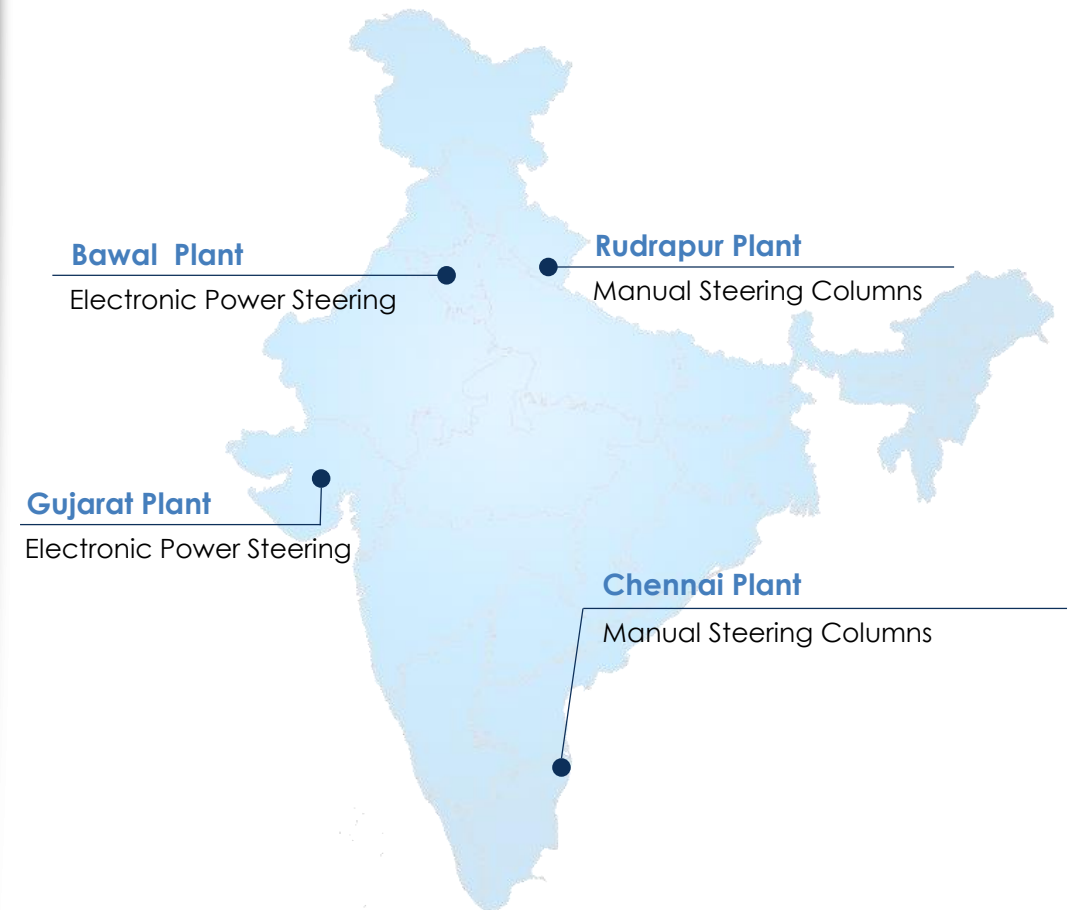

## Light Metal Casting Products

Pinion Housing

Engine Timing Case Cover

Outboard Housing

## Valve train Components

Engine Valves

## Occupant Safety Systems

Seat Belts

Airbags

## Friction Materials

Brake Lining

Disc Pad

Upper Control Arm

Stabilizer Link

Lower Control Arm

## Steering & Suspension Systems

Suspension Ball Joint

Outer Ball Joint

Inner Ball Joint

Power Steering Pump

Rack & Pinion steering gear  
-Mechanical  
-Hydraulic

Electric Power Steering Columns

### Rane (Madras)

- › Manual Steering Gears
- › Steering Linkages
- › Suspension Components
- › Light Metal Casting Products

### Rane Engine Valve

- › Engine Valves

### Rane Brake Lining

- › Brake Linings
- › Disc Pads

### Rane NSK Steering Systems

- › Electric Power Steering Systems

### ZF Rane Automotive India Pvt Ltd.

- › Hydraulic Power Steering systems
- › Seat Belts
- › Airbags

## Steering & Suspension Systems



Manual Steering Column



Power Steering Gear



Power Steering Pump



Manual RCB Steering Gear



Drag Link Assembly



Tie Rod Assembly

Hydraulic Cylinder (Twin/multi front axle trucks)



## Light Metal Casting Products

Hydraulic Pump Housing



## Occupant Safety Systems

Seat Belts



## Friction Materials

Brake Lining



Disc Pad



## Valve train Components

Valve Guides



Engine Valves

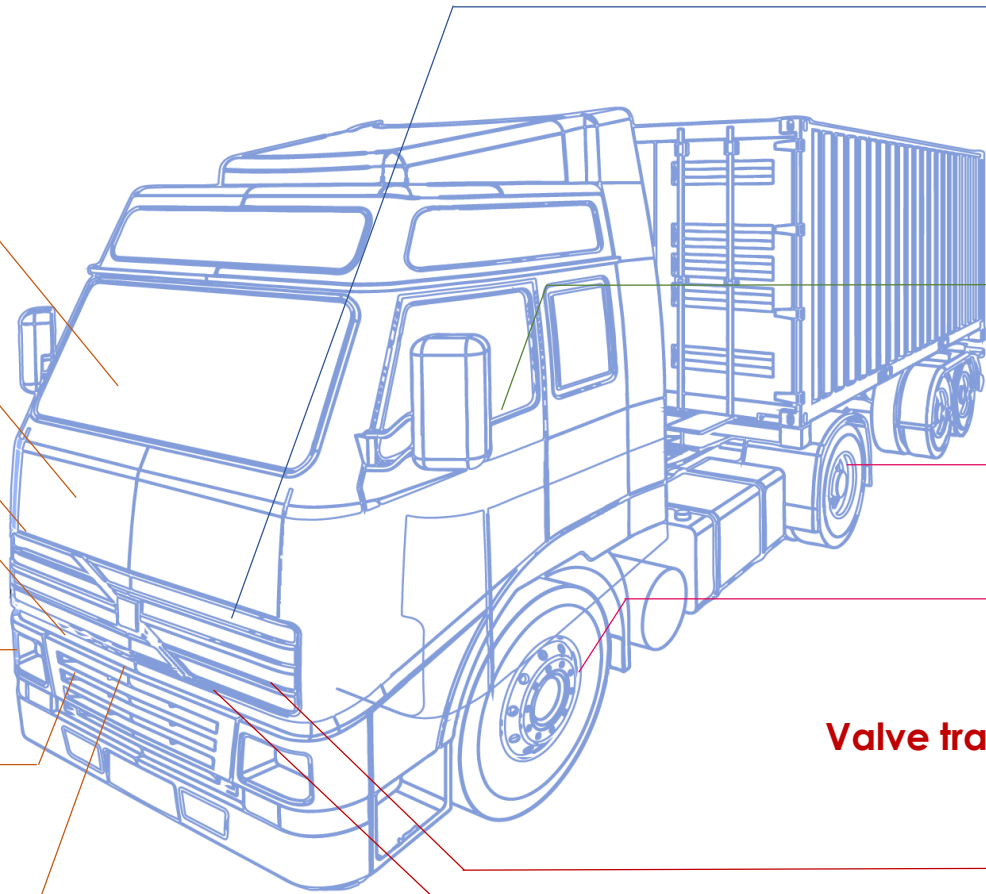

### Rane (Madras)

- › Manual Steering Gears
- › Steering Linkages
- › Hydraulic Cylinders
- › Light Metal Casting Products

### Rane Engine Valve

- › Engine Valves
- › Valve Guides

### Rane Brake Lining

- › Brake Linings
- › Brake Pads

### Rane NSK Steering Systems

- › Manual Steering Column

### ZF Rane Automotive India Pvt Ltd.

- › Hydraulic Power Steering Systems
- › Seat Belts

## Steering & Suspension Systems



Manual Steering /  
Column  
Manual RCB  
Steering Gear



Hydrostatic  
Steering Unit



Power Steering  
Gear



Drag Link Assembly



Tie Rod Assembly

Hydraulic  
Cylinder



## Friction Materials

Clutch Facings



Brake Lining

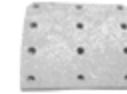

## Light Metal Casting Products

Timing Case Covers



Seat Belts



## Valve train components

Valve Guides



Engine Valves



### Rane (Madras)

- › Manual Steering Gears
- › Steering Linkages
- › Hydraulic Cylinders
- › Hydrostatic Steering Unit
- › Light Metal Casting Products

### Rane Engine Valve

- › Engine Valves
- › Valve Guides

### Rane Brake Lining

- › Brake Linings
- › Clutch Facings

### Rane NSK Steering Systems

- › Manual Steering Column

### ZF Rane Automotive India Pvt Ltd.

- › Hydraulic Power Steering systems
- › Seat Belts

## Light Metal Casting Products

### Battery Box & Cover

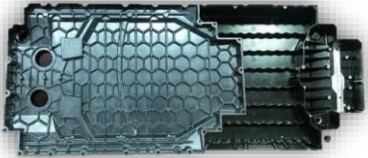

## Friction Materials

### Disc pad

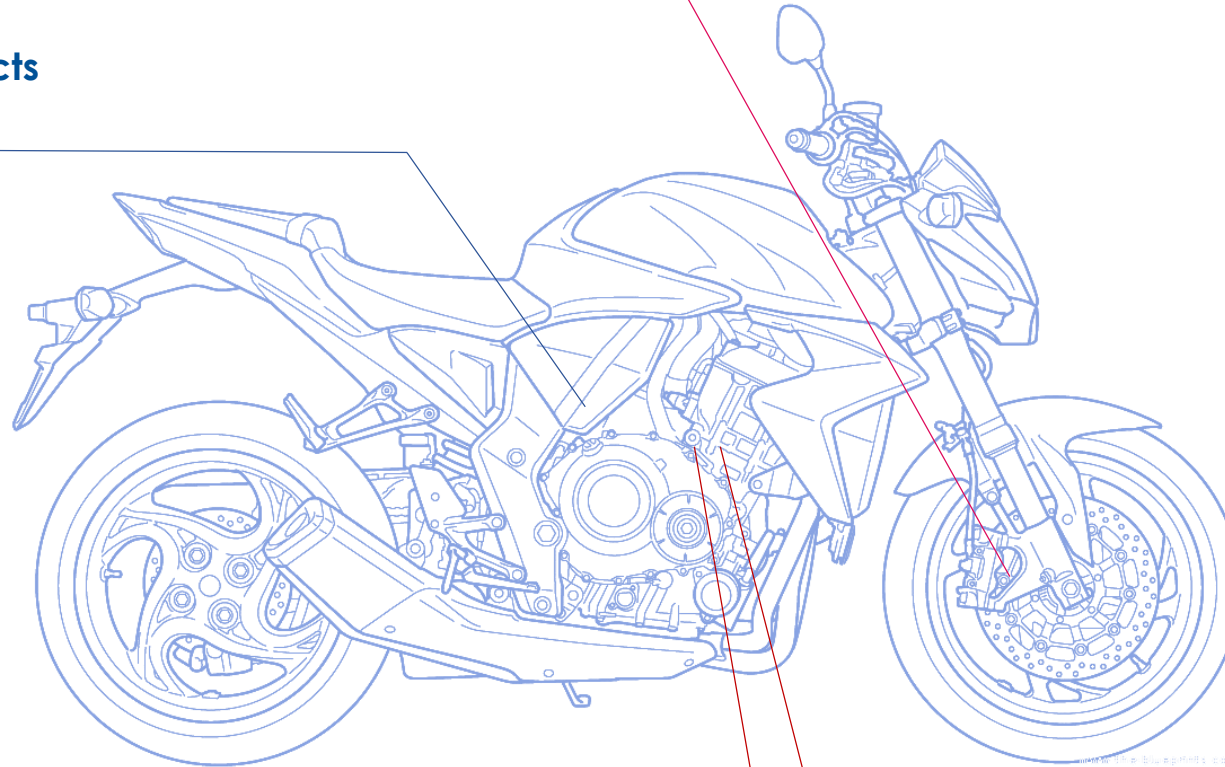

## Rane (Madras)

- › Light Metal Casting Products

## Rane Brake Lining

- › Disc Pads

## Rane Engine Valve

- › Engine Valves
- › Valve Guides

## Valve train Components

### Valve Guides



### Engine Valves



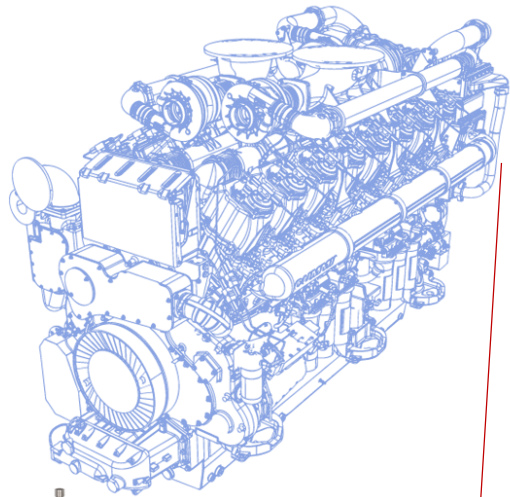

**Engine Valves / Valve Guides**

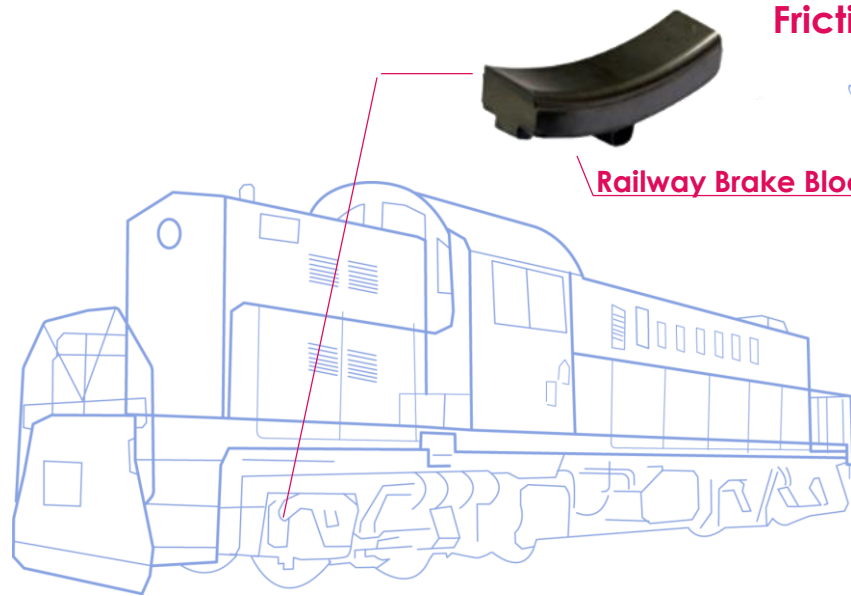
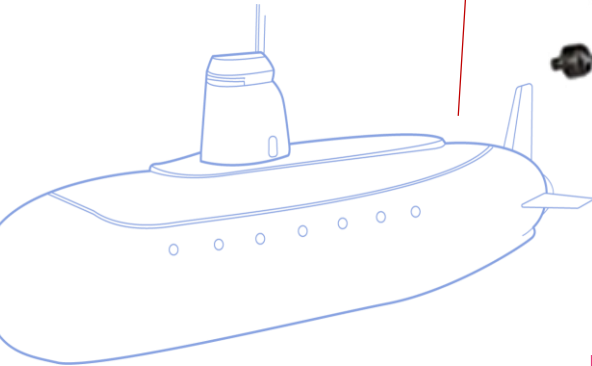

**Railway Brake Block**

**Friction Materials**

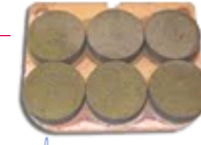

**Sintered Brake Pads**

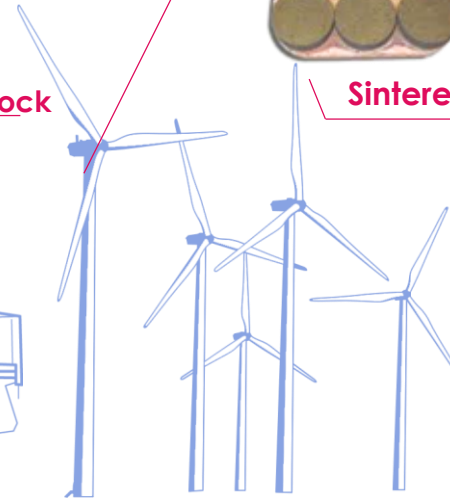

**Suspension Ball Joint**

**Outer Ball Joint**

**Inner Ball Joint**

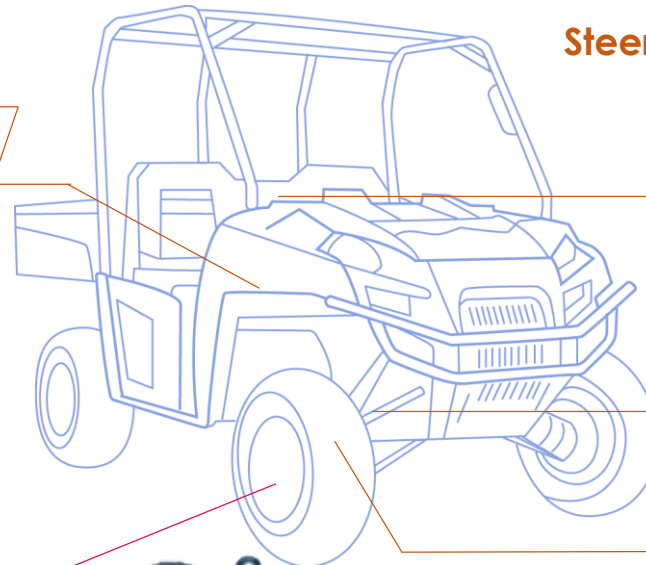

**Steering & Suspension Systems**



**Steering Shafts**



**Rack & Pinion steering gear -Mechanical**



**Stabilizer link**



**Friction Materials / Disc pad**

**Rane (Madras)**

- › Manual Steering Gears
- › Steering Linkages
- › Light Metal Casting Products

**Rane Engine Valve**

- › Engine Valves
- › Valve Guides

**Rane Brake Lining**

- › Sintered Brake Pads
- › Railway Brake Block

**Rane NSK Steering Systems**

- › Steering Shafts

## An illustrious journey of over 80 years from distributor of automobile and auto components to winner of Deming prize for manufacturing

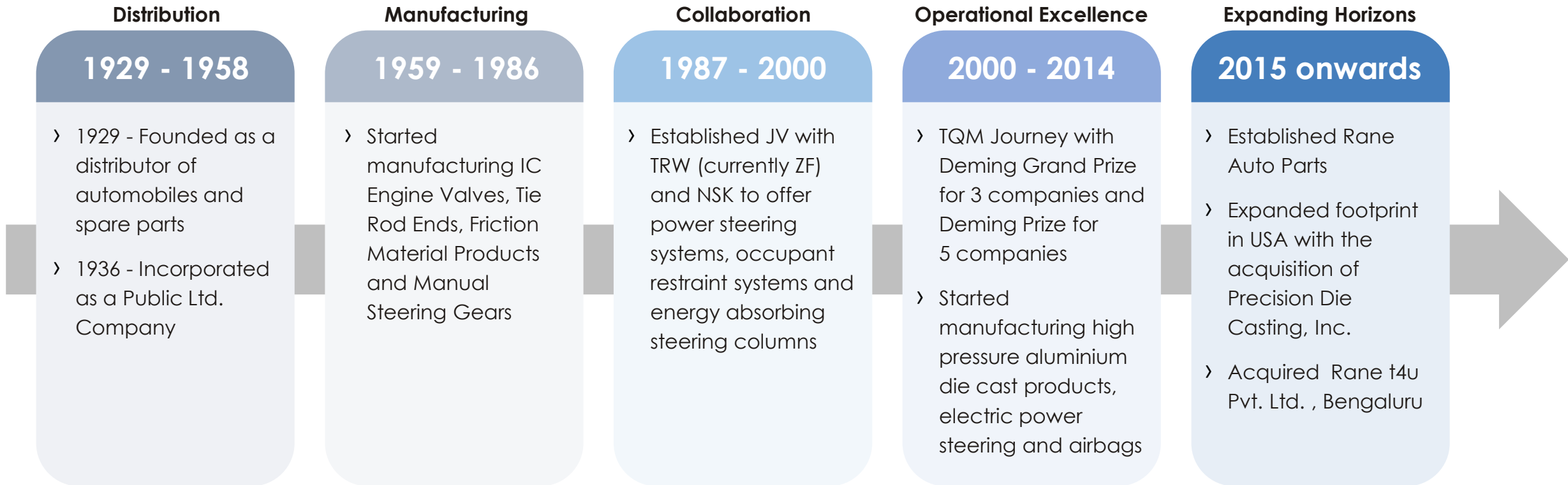



**30+** Serve customers in 30+ countries

**26** Manufacturing locations across India and USA

Customer Locations   Manufacturing Locations   Sales Offices



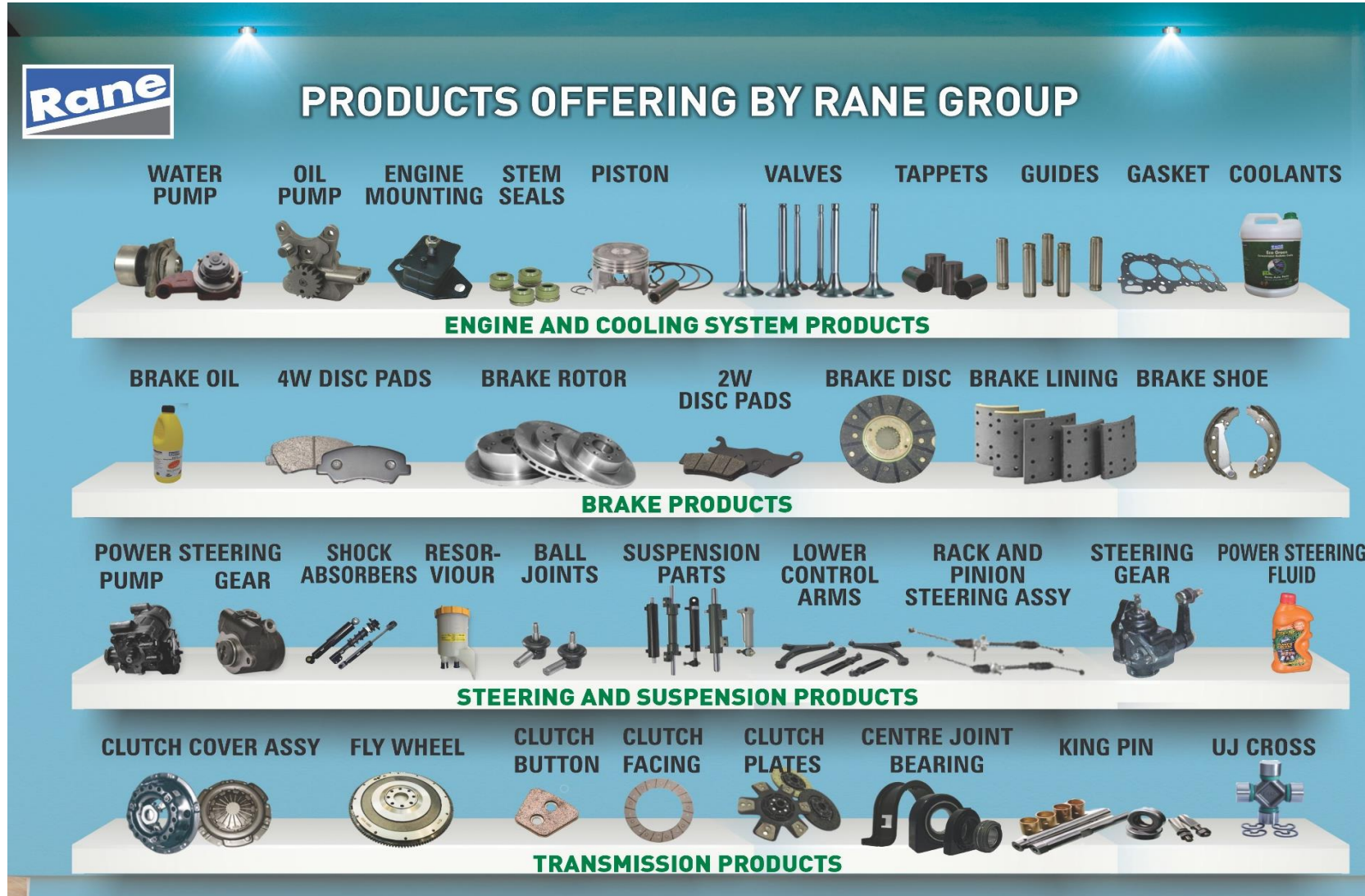

Increasing Group's brand presence in aftermarket through enhanced product portfolio and wider market reach

## Strong CAE Capabilities – Design, Analysis & Simulation Software

**230** R&D Engineers

**42** Functional Test Rigs

**26** Strength Test Rigs

**62** Durability Test Rigs

**33** Environmental Test Rigs

**10** Noise Test Rigs



Hydraulic Power Steering Systems and Occupant Safety Systems



Energy Absorbing Steering Columns and Electric Power Steering



Brake Linings, Discs Pads and Clutch Facings

INDIA

Passenger Vehicle



Commercial Vehicle



Farm Tractor



Two/Three-Wheeler



Other Applications



INTERNATIONAL



**'Customer at the core' remains our priority on the goal to sustainable growth and profitability**



## Rane Group

Customer	Award Category
<b>Mahindra &amp; Mahindra</b>	Business Partner of the year – Automotive Division



## Rane (Madras)

Customer	Award Category
<b>Volvo Eicher</b>	New Product Development Award
<b>Nexteer TAFE</b>	Perfect Quality Award Best Supplier & Benchmark Award
<b>Maruti Suzuki</b>	Superior Performance Award, Special Support
<b>SML Isuzu</b>	New Product Development Award
<b>Tata Motors</b>	Award for Exceptional Support, Best Supplier – Demand Fulfillment
<b>Toyota Industries</b>	Best Target Achieved Supplier Award



## Rane Brake Lining

Customer	Award Category
<b>Brakes India</b>	Best Supplier - Friction
<b>Ashok Leyland</b>	After Market Support Award
<b>Foundation Brake</b>	Business Excellence Award Gold Award for Quality Best Benchmark Award, Best Supplier Award, Consistent Vendor Rating Performance Award
<b>Endurance</b>	



## Rane Engine Valve

Customer	Award Category
<b>Groupe Renault</b>	Quality & Customer Satisfaction
<b>John Deere India</b>	Quality Appreciation Award
<b>Volvo Eicher</b>	Quality & Delivery excellence
<b>Renault Nissan</b>	Quality & Customer Satisfaction
<b>Hyundai</b>	Appreciation Award
<b>Cummins India</b>	Superior Quality Award



## ZF Rane

Customer	Award Category
<b>Ashok Leyland</b>	Best Performance in Business Alignment-Gold
<b>Isuzu Motors</b>	Most Improved Supplier Award
<b>Tata Motors</b>	Best Supplier Award, Efficiency Award, Best in Class Award
<b>Volvo Eicher</b>	Best Supplier in NPD, Supply Chain
<b>Daimler India</b>	Quality Appreciation Award
<b>Renault Nissan</b>	Best Supplier in Field Quality



## Rane NSK

Customer	Award Category
<b>Maruti Suzuki</b>	Efforts in Vendor Import Localisation
<b>Honda Cars</b>	Award for best reduction in CO2
<b>Volvo Eicher</b>	Quality Excellence
<b>Daimler India</b>	Best Technology Support

## Rane Values

- › Provide superior products and maintain market leadership
- › Pursue excellence
- › Achieve the highest standard of ethics and integrity

## Rane Approach

- › Build strong connections with customers to understand their challenges
- › Strategic investments to improve quality and productivity
- › TQM way of working
- › Emphasis on 'First-time right' policy

## Rane Credentials

- › Modern manufacturing facilities with TS 16949 certification
- › State-of-the-art product development and validation capabilities
- › Deming Grand Prize for 3 Rane companies
- › Deming Prize for 5 Rane companies



- › Technology collaboration with top global players



ZF Group, Germany  
Hydraulic Power Steering Systems and Occupant Safety Systems



NSK, Japan  
Energy Absorbing Steering Columns and Electric Power Steering



Nisshinbo Brake Inc., Japan  
Brake Linings, Disc Pads and Clutch Facings

## Value Proposition

- › Superior products driven by execution excellence
- › Trusted partner with shorter development lead times
- › Agile manufacturing process and scalable facilities
- › Provide system-level solutions with deep understanding of customer needs
- › With enhanced R&D capabilities, we provide light-weighting, improved safety and performance

**LONG TERM PARTNER OF CHOICE TO LEADING  
AUTOMOTIVE COMPANIES AND TIER 1 SUPPLIERS**

An exciting workplace founded on the principles of values, fairness and transparency that:



Provides challenging assignments

Encourages learning

Enhances career opportunities



- › **Organisation Development Excellence Award** for the exceptional practices on **Leadership Development** by Transcendence, Tata Institute of Social Sciences (TISS), 2019
- › Recognized by International Federation of Training and Development Organizations in Best HRD practice category, 2018
- › Award for **Talent Management** from the Employer Branding institute, Singapore, 2012 & 2014
- › Significant Achievement in **HR Excellence**, CII, 2012



Certified as a **Great Workplace** by the Great Place to Work institute, 2022



## Systems approach to deliver H&S to our employees

Legal & Compliance

Emergency Preparedness & Response

Policies & Procedures

Risk Reduction

Training

Organizational Structure and Communication

Audit Structure

- › Rane Foundation (RF) is a **public charitable trust** founded by Rane's promoters in the year 1967
- › RF is the **main arm for Rane's Corporate Social Responsibility (CSR) initiatives** and is exclusively funded by the Rane companies
- › Initiatives are focused on **education, healthcare, environment and community development**

## Rane Polytechnic



### Education

- › Institution Development - Rane Polytechnic, Rane Vidyalaya
- › Vocational Training & Skill Development
- › Awareness programs



### Healthcare

- › Nutrition program
- › Health camps
- › Medical infrastructure & aid



### Environment

- › Plantation drives
- › Infrastructure for sustainability
- › Natural resource preservation



### Community Development

- › Providing amenities & sanitation
- › Improving quality of life
- › Rural infrastructure development program

## Rane Vidyalaya



# Thank You

For further information, please contact:

[investorservices@ranegroup.com](mailto:investorservices@ranegroup.com) or [diwakar.pingle@in.ey.com](mailto:diwakar.pingle@in.ey.com)

## **Rane Corporate Centre**

"Maithri" 132, Cathedral Road,  
Chennai - 600 086, India  
[www.ranegroup.com](http://www.ranegroup.com)



## Glossary of Abbreviations

Abbreviation	Expansion	Abbreviation	Expansion
ACMA	Automotive Component Manufacturers Association	OES	Original Equipment Supplier
bps	Basis point, 100 bps equal to 1%	PAT	Profit After Tax
BV	Book Value per share	PBT	Profit Before Tax
Cr	Crores	PC	Passenger Car
CV	Commercial Vehicle	PLE	Production Linked Incentive
DPS	Dividend per share	PV	Passenger vehicle
EBITDA	Earnings Before Interest, Tax, Depreciation and Amortization	Pvt	Private
EPS	Earnings per share / Electronic power steering	Q4	Quarter 4
EV	Electric vehicle	Rane T4U	Rane T4U Pvt Limited
FT	Farm Tractors	RBL	Rane Brake Lining Limited
FY	Financial Year	REVL	Rane Engine Valve Limited
HR	Human Resource	RHL	Rane Holdings Limited
IC	Internal combustion	RLMCA	Rane Light Metal Casting Inc
Intl	International	RML	Rane (Madras) Limited
JV	Joint Venture	RNSS	Rane NSK Steering Systems Pvt Limited
LCV	Light Commercial Vehicles	ROCE	Return on capital employed
Ltd	Limited	R&P	Racks and pinions
M&HCV	Medium & Heavy Commercial Vehicles	SE	Station Engine
Mn	Million	US	United States
MSC	Manual steering columns	USD	United States Dollar
NM	Not material	VRS	Voluntary Retirement Scheme
NPD	New Product Development	YoY	Year-on-Year
OE	Original Equipment	ZRAI	ZF Rane Automotive India Pvt limited
OEE	Overall equipment effectiveness	ZROS	ZF Rane Occupants Systems Pvt Ltd.
OEM	Original Equipment Manufacturer	2W/3W	Two Wheeler/Three Wheeler

*This presentation may contain certain forward looking statements concerning Rane's future business prospects and business profitability, which are subject to a number of risks and uncertainties and the actual results could materially differ from those in such forward looking statements. The risks and uncertainties relating to these statements include, but not limited to risks and uncertainties regarding fluctuations in earnings, our ability to manage growth, competition (both domestic and international), economic growth in India and the target countries for exports, ability to attract and retain highly skilled professionals, government policies and action with respect to investments, fiscal deficits, regulations etc., interest and other fiscal costs generally prevailing in the economy. The company does not undertake to make any announcement in case any of these forward looking statement become materially incorrect in future or update any forward looking statements made from time to time by or on behalf of the Company.*