



Formerly Known as-  
Bansal Roofing Products Private Limited  
Bansal Roofing Private Limited

**Bansal Roofing Products Ltd.**

*The roofing people...*

**NSIC-CRISIL Rated Company, An ISO 9001-2008 Company**

Registered Office : 3/2, Labdhi Industrial Estate, Acid Mill Compound, Ranmukteshwar Road, Pratapnagar, Vadodara-390 004, Gujarat-India.  
(L) : +91-265-2580178 Telefax: +91-265-2581365, (M) : +91-9909002682 Email : cs@bansalroofing.com  
CIN No. L25206GJ2008PLC053761, Website : www.bansalroofing.com

Date: 11.09.2016

To,  
General Manager  
BSE Limited  
Phiroze Jeejeebhoy Towers,  
Dalal Street, Mumbai - 400 001

Dear Sir/Madam,

We enclose herewith investor presentation and summarized information of the Company detailing executive summary, industry overview, geographical presence, financial overview, etc. for your information.

The same will be simultaneously uploaded on our website.

For Bansal Roofing Products Limited

Krupali Joshi

Company Secretary and Compliance Officer

Encl: As below





# Bansal Roofing Products Ltd.

Investor Presentation – September 2016

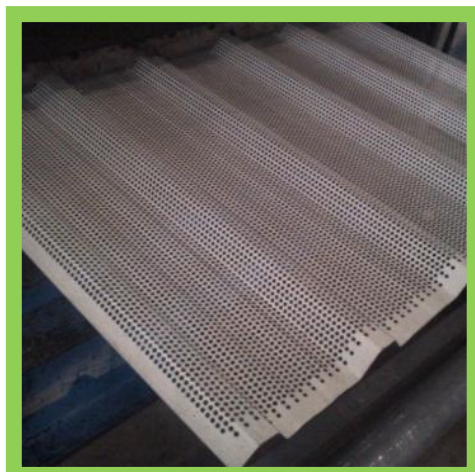
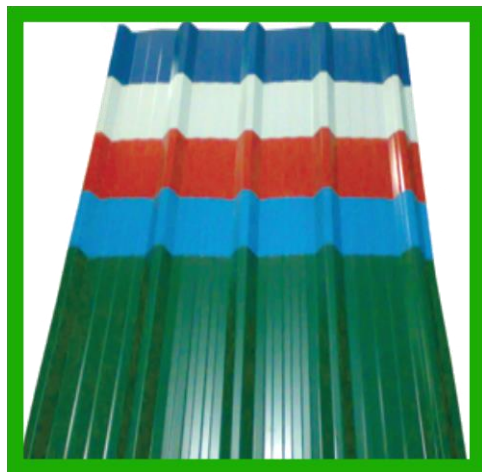

- 1** **Executive Summary**
- 2** **Company Overview**
- 3** **Business Structure**
- 4** **Industry Overview**
- 5** **Financial Overview**

# Executive Summary



# Executive Summary



## Overview

- Bansal Roofing Products Ltd. was established in the year 2008 by experienced technocrats having 20 years of experience in the field of Production, Marketing, and Projects Management. It is listed on SME platform of Bombay Stock Exchange(BSE)
- The Company was incorporated in 2008, initially foraying into business of marketing of roofing sheets. It then moved into trading and later on into manufacturing of roofing & accessories.
- The company started their commercial production in the year 2012. Since then they have grown rapidly to become a one-stop solution provider for all roofing requirements.

## Key Financial Highlights (INR) :

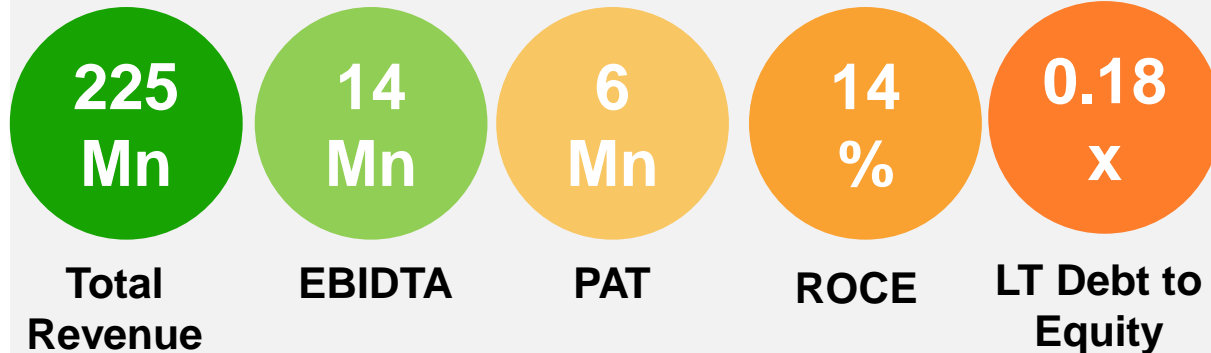

## Key Strength:

- Experienced Management Team
- Necessary qualifications in place for tender business
- Strong Range of Products, Strong Brand Image
- One-stop solution for roofing requirements
- Extensive and Cost beneficial Manufacturing Facility
- Quality Assurance and Standards
- Recently forayed into Pre-engineered structures to expand the product basket

## Product Basket

- “BRPL” is a quality manufacturer of roofing products like:
- Color Coated Metal sheets ( PPGI, PPGL, Bare galvalume, Aluminum)
  - Flashing/ Accessories
  - FRP Plain & Profile sheets
  - Polycarbonate sheets
  - Perforated sheets
  - Turbo ventilators
  - “Z and C” purlin
  - Metal Deck sheets
  - Pre-engineered building

# Company Overview



# ■ ■ ■ ■ About Bansal Roofing Products Limited



Plain Ridge

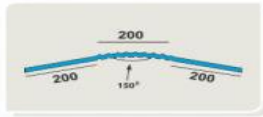

Crimped Ridge

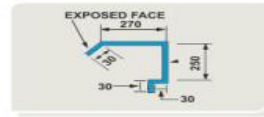
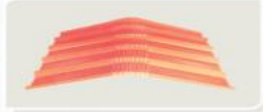

Gable End Flashing

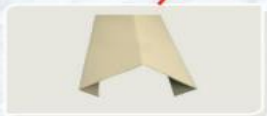
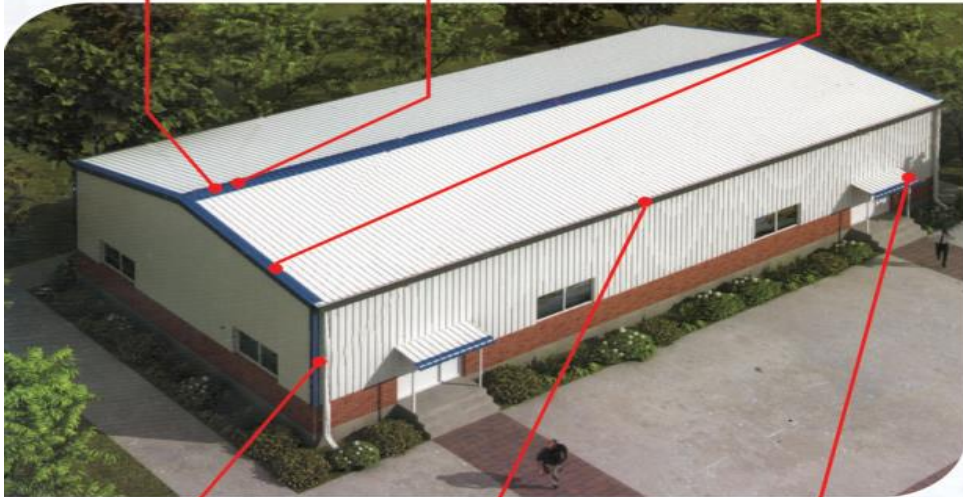

Corner Flashing

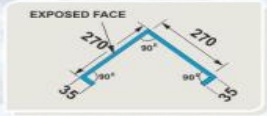

Roof Gutter

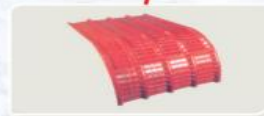
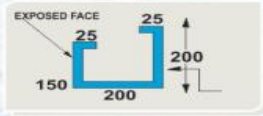

North Light Curvature

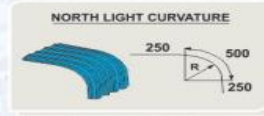

The company is mainly a manufacturer of roofing sheets and roofing accessories such as Colour Coated Roof Sheets, FRP Roof Sheets, Polycarbonate Sheets. It also manufacture Eco Ventilators and other miscellaneous Roofing Accessories and provide all roofing solutions our valuable customers, under one roof.

The company commenced manufacturing and fabrication of pre-engineered building (PEB) in 2014- 15.

Company's manufacturing facility is situated near Vadodara, Gujarat. The products manufactured by the Company are made on automatic and semi automatic Roll forming machine, Crimping Machine, Shearing Machine and folding machine.

The company has installed capacity to manufacture 1700 tones on a monthly basis. The company is currently utilizing 35 per cent of its total installed capacity.

Bansal Roofing Products Limited (BRPL) is a CRISIL rated SME Company having "SE-2B" rating which means High Performance Capacity & Moderate Financial Strength. "BRPL" has been awarded with SKOCH ORDER OF – MERIT as INDIA'S BEST SMEs in March, 2015.

"BRPL" is also ISO 9001:2008 certified company and was listed on BSE SME exchange dated 14th July, 2014.

Key products manufactured by BRPL are Metal Roofing sheets, Pre-engineered building and allied products.

# Key Management



## **Kaushalkumar S Gupta - Director / Key Management Personnel**

- Aged 46 years, is the Chairman & Managing Director of the Company.
- He holds a Bachelor's Degree in Industrial Engineering from Saurashtra University.
- He is one of the founder promoters of the Company and the Director since incorporation.
- He has more than 22 years of experience in various business activities ranging from Trading, Distribution, Manufacturing and Consulting.
- His main role in the Company is to strategize new business plans with industry trends and consumer preference in mind.



## **Beena P Bisht - Ind. Non-Executive Director**

- Aged 40 years, holds a B.A. degree in Human Resource
- She handles the investor grievance committee of the company and has a 2 year experience with the company.



## **Shilpa A Jadeja - Ind. Non-Executive Director**

- Aged 45 years, hold a M.Sc. degree in Physics
- She handles the remuneration committee and has a 2 year experience with the company.



## **Sangeeta K Gupta - Director / Key Management Personnel**

- Aged 43 years, is also one of the founder promoters of the Company.
- She holds a Bachelor's degree in Arts (English Entire) from The Maharaja Sayajirao University of Baroda.
- She is responsible for internal operations and staff support services of the Company.
- She was originally appointed as Director of the Company on incorporation and was appointed as Whole-time Director of the Company on January 09, 2014.



## **Satishkumar S Gupta - Director / Key Management Personnel**

- Aged 55 years, is Director/Sales of the company .
- He holds a Diploma (Mechanical engineering).
- He has an experience of 20 years with ABB Limited as an executive engineer and 5 years with the company



## **Bhavita D Gurjar - Ind. Non-Executive Director**

- Aged 30 years.
- Has completed her B.com, is in the audit committee of the company and has 2 years with the company



# Key Management

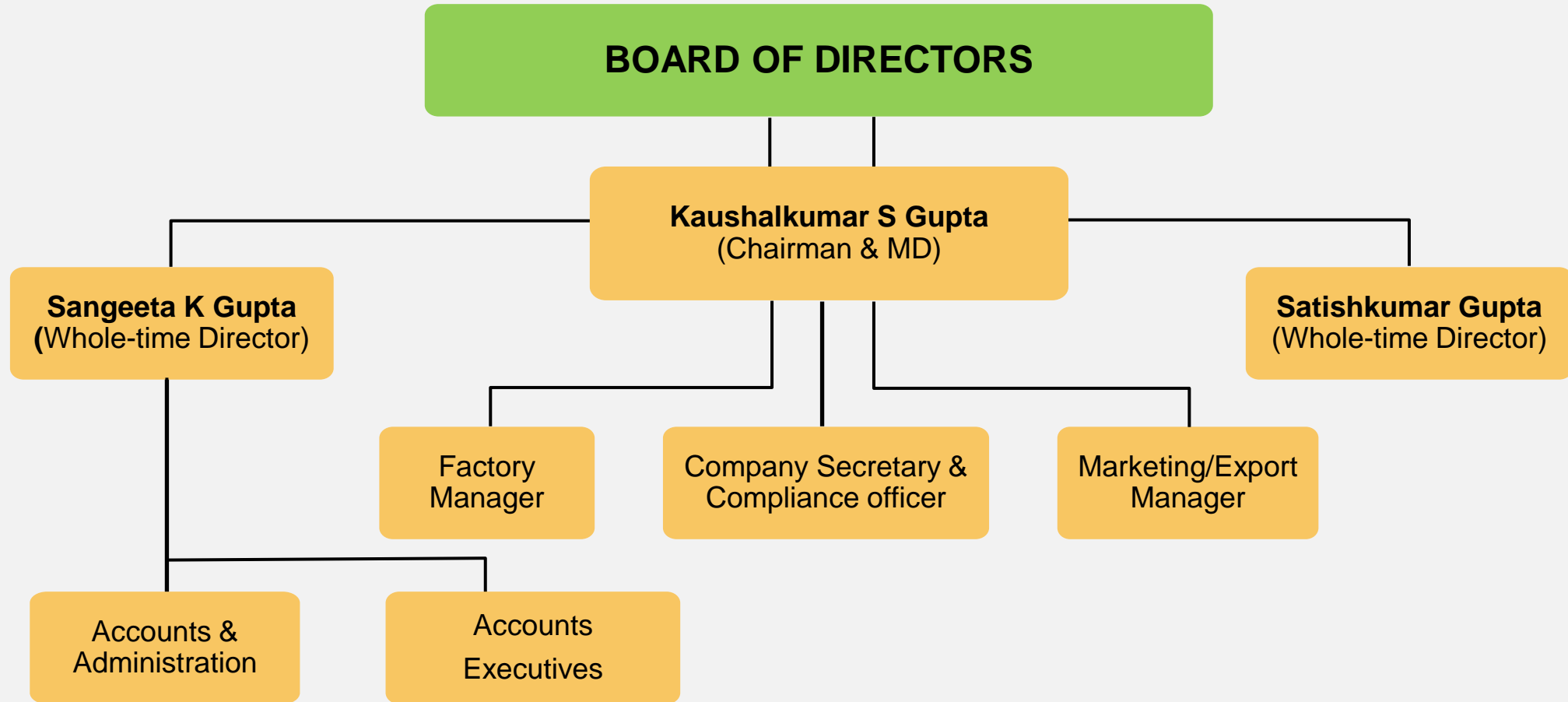

# Milestones

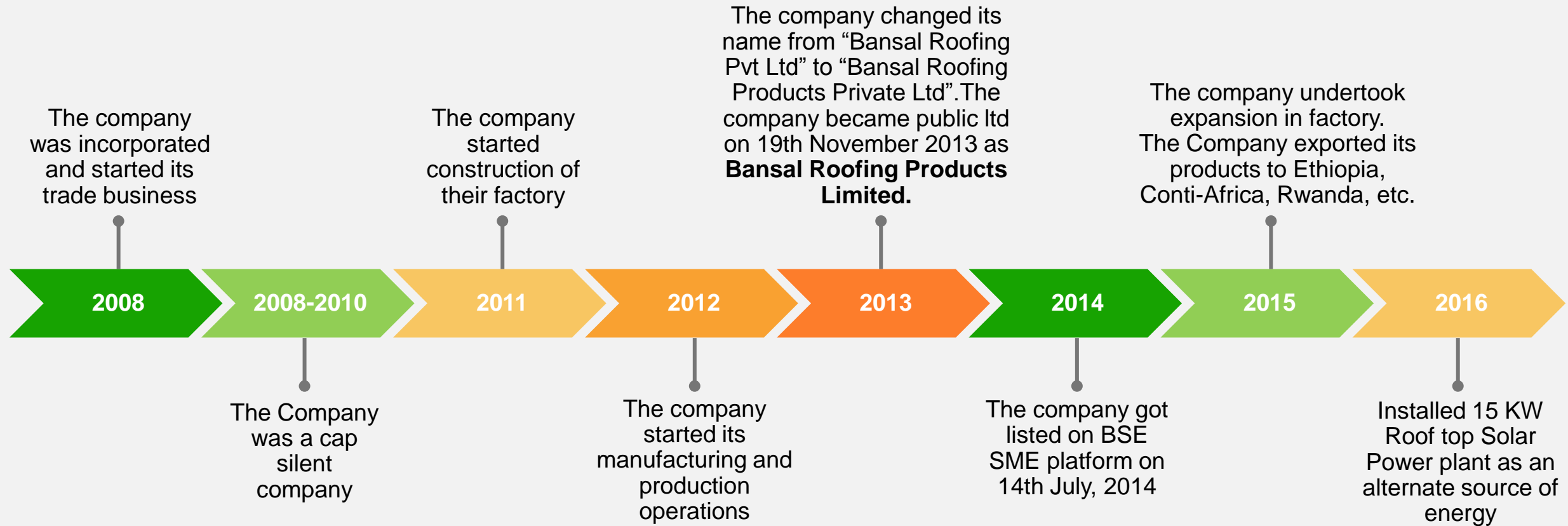

# Marquee Clients



# Our Facilities



**State:** Gujarat  
**District:** Vadodara  
**Capacity:** 1700 tonnes pm.  
**Number of Employees:** 41



# Our Facilities



Shearing Machine



Roll Forming Machine



Z & C Machine



Crimping Machine



Folding Machine



Gang Slitting Machine



Hydraulic Press Machine



De Coiler

# Geographical Presence

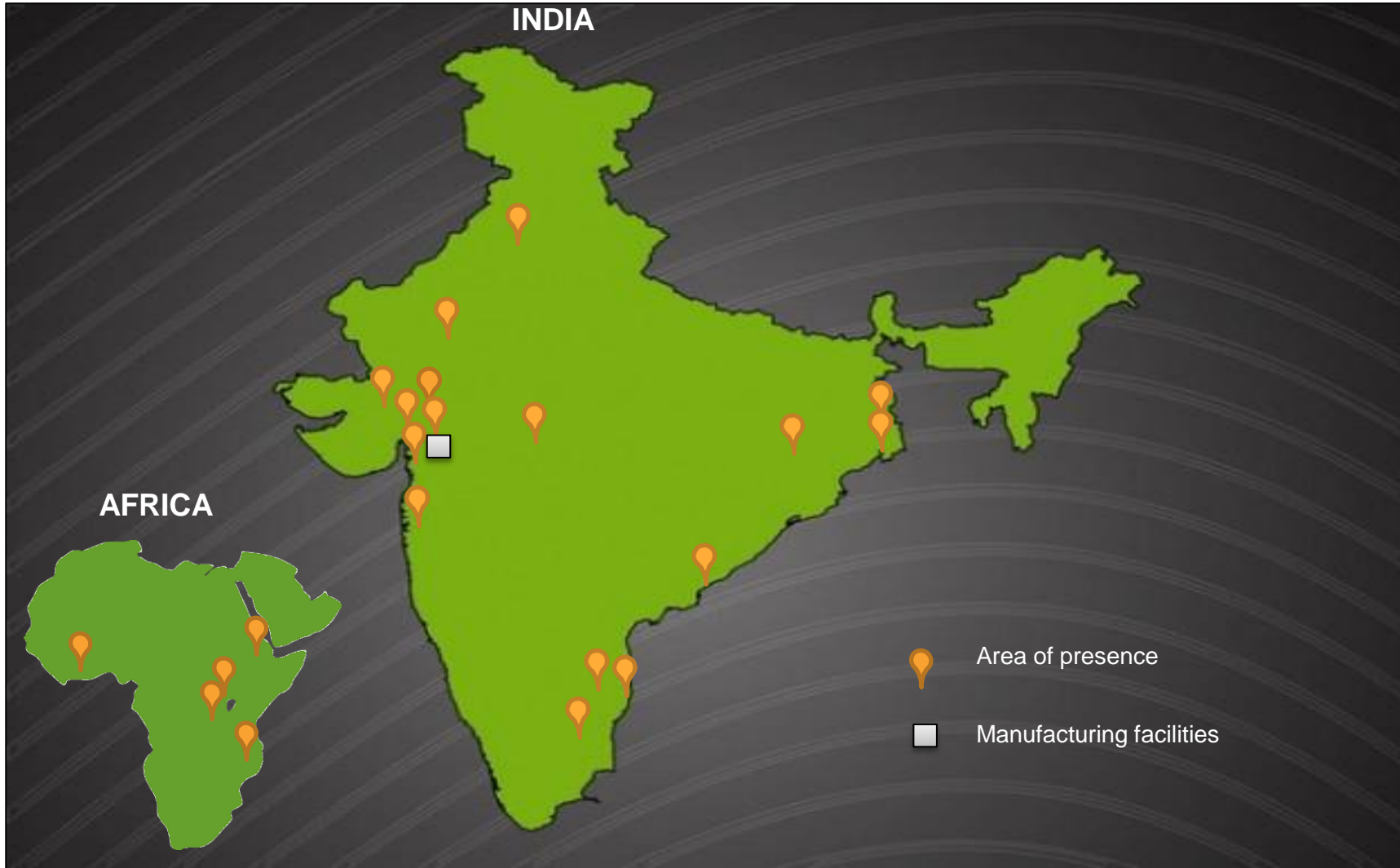

Region	State
Trichy Ranipet Vishakhapatnam	Telangana
Bhopal	Madhya Pradesh
Haldia Kolkata	West Bengal
Beawar	Rajasthan
Mumbai	Maharashtra
Nandesari Dahej Ahmedabad Mehsana Ekalbara Padra	Gujarat
Chennai	Tamil Nadu
Joda	Orissa
Hisar	Haryana

- East African Countries - Uganda, Ethiopia, Tanzania, Rwanda.
- West African Countries - Ghana

# Key Strengths



# Future Strategy



## Future Strategy:

- Focus on high margin products and reduce revenue share of low margin products
- Increased focus on exports
- Increase the productivity further by 40-50%
- Improve Utilisations

## Revenue Targets:

- FY 16-17: 30Cr
- FY 17-18: 40Cr
- FY 18-19: 50Cr

## Profit Targets:

- FY20 to improve profitability by 5X from current levels



# Business Structure



# Business Structure



Roofing	Accessories	Other Roofing Products	Pre-engineered structures
<b>Revenue Contribution: 75%</b>	<b>Revenue Contribution: 10%</b>	<b>Revenue Contribution: 10%</b>	<b>Revenue Contribution: 5%</b>
<b>Products:</b> <ul style="list-style-type: none"> <li>• Color coated Roofing sheets</li> </ul>	<b>Products:</b> <ul style="list-style-type: none"> <li>• North light curvature</li> <li>• Roof gutter</li> <li>• Crimped Ridge</li> <li>• Gable End Flashing</li> <li>• Corner flashing</li> <li>• Plain Ridge</li> <li>• Other roofing Products</li> <li>• Miscellaneous Products</li> </ul>	<b>Products:</b> <ul style="list-style-type: none"> <li>• Perforated metal Sheet</li> <li>• FRP roofing sheets</li> <li>• Polycarbonate Sheet</li> <li>• Metal Deck Sheet</li> <li>• "Z" And "C" Purlins</li> <li>• Eco ventilators</li> </ul>	<b>Products:</b> <p>Pre-engineered structures</p>
<b>Capacity: 1250 tonnes p.m.</b> <b>Capacity Utilization: 35%</b> <b>Gross Margins: 5-6%</b>	<b>Capacity: 25 tonnes p.m.</b> <b>Capacity Utilization: 35%</b> <b>Gross Margins: &lt; 20%</b>	<b>Capacity: 310 tonnes p.m.</b> <b>Capacity Utilization: 35%</b> <b>Gross Margins: 15-25%</b>	<b>Capacity: 100 tonnes p.m.</b> <b>Capacity Utilization: 25%</b> <b>Gross Margins: 15-20%</b>

# Our Products

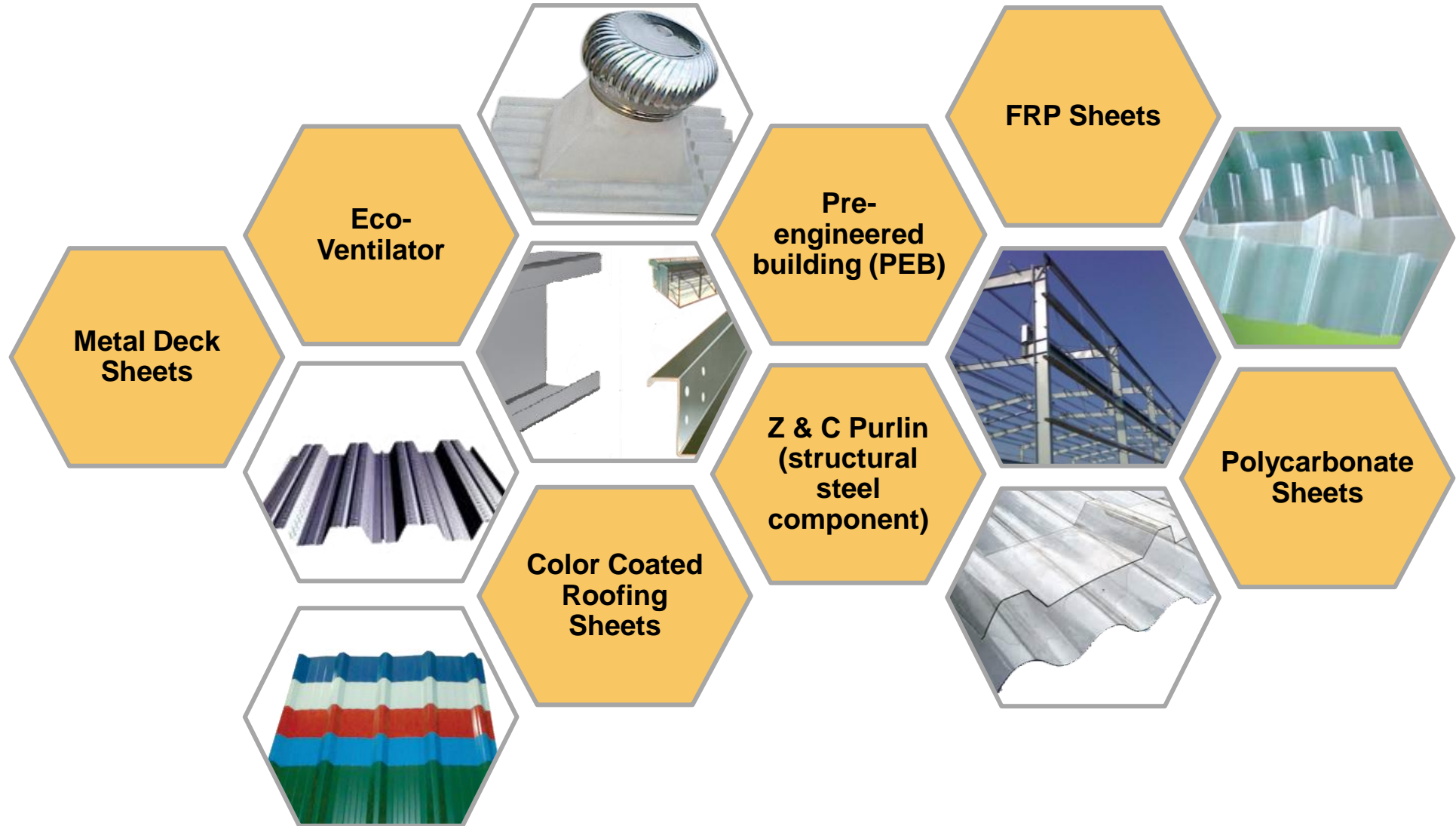

# Roofing – Colour Coated Roofing Sheets

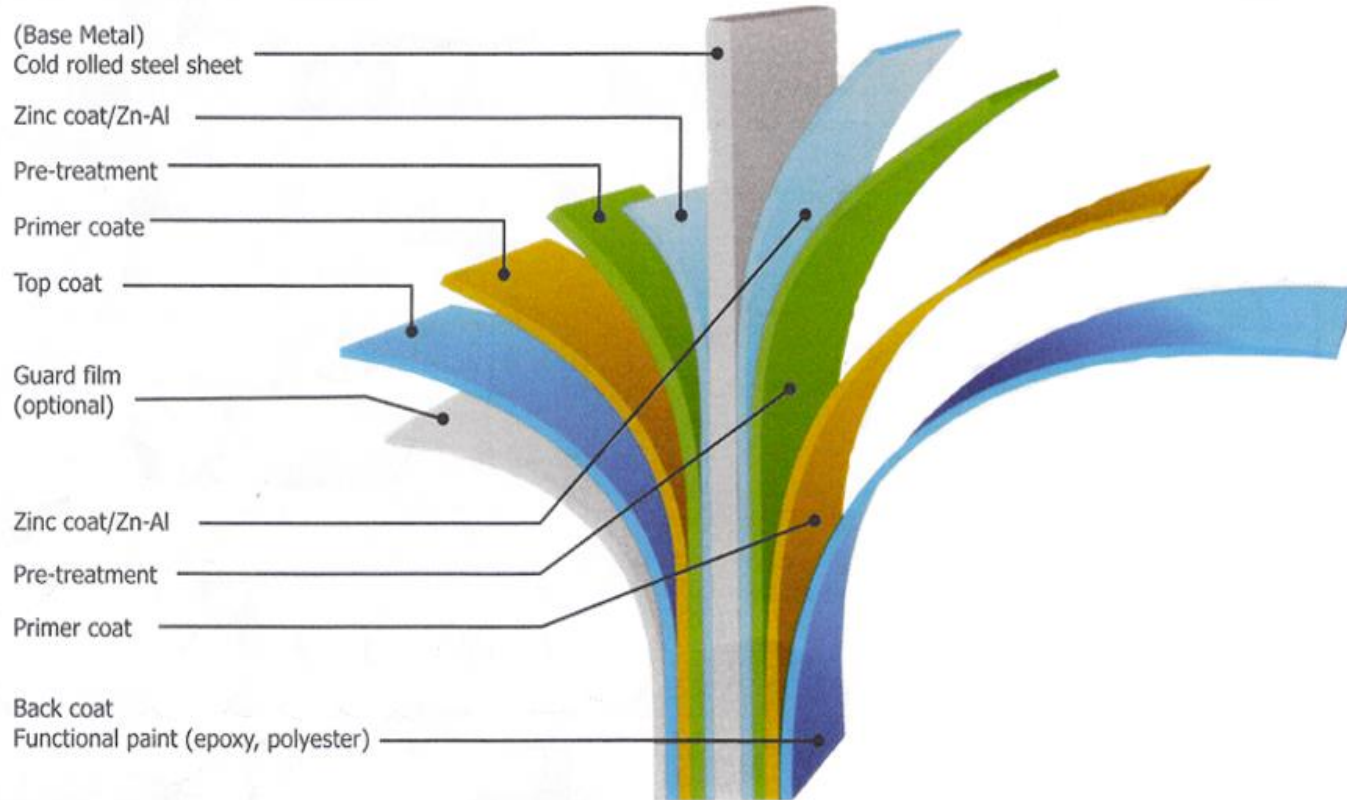

Colour Coated Roofing Sheets are highly durable roofing sheets which have high quality colour coating throughout the roof or cladding. The thickness of coating depends on the weather conditions and its use. These roofing sheets come with lining enamel which is used as internal lining.

Bansal 1000 Profile [Hicover]



Bansal 980 Profile [Histrength]

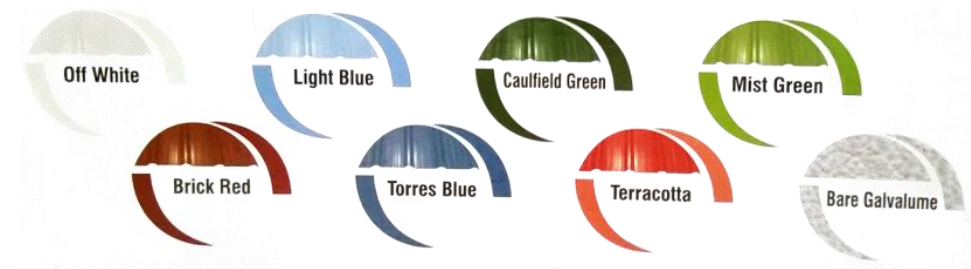

## Applications :

1. Residential and Commercial buildings
2. Airport, Railways, Power houses
3. Shopping Malls
4. Barricading
5. Manufacturing Industries
6. Warehouses
7. Cold storages
8. Auditorium

# Accessories – Color Coated Roofing Accessories

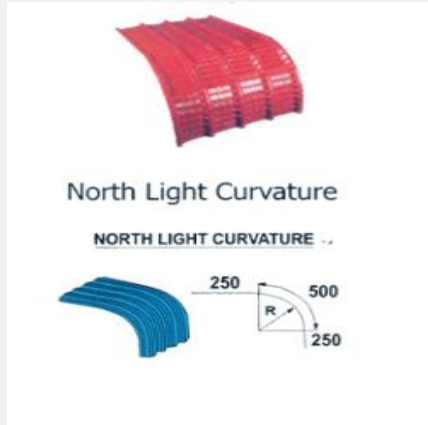

# Accessories – Other Roofing Products

## Product Range

1. Roofing Fasteners
2. "J", "L", "Pipe bolt (Galvanized & PVC Coated)
3. Foam Frillier (For Ends) & Silicon Sealant
4. PVC & PP Cap
5. Roofing Accessories - Ridge, Corner, Gabble, Gutter
6. Louvers
6. Butyle Tap
7. Sag Rod
8. Foundation Bolt
9. Brazing Rod
10. Clits
11. Base Plates

## Roofing Fasteners: (SELF DRILLING CUM TAPPING SCREWS (SDT))

It is very important to use right length and diameter of screw. also assure pitch of the screw, coating quality and salty spray test detail.



## Butyle Tap:

Butyle tapes are applied over side and lap sheets to prevent ingress of water. These are necessary for ensuring water tight sealing of roof. Roof below seven degree slopes necessarily require these tapes and are applied as shown below.

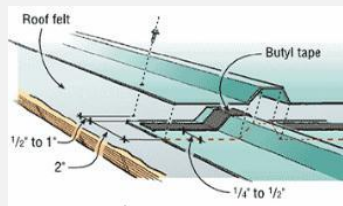
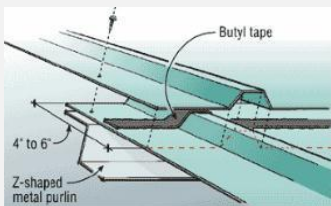

## Foam Frillier (For Ends) : Silicon Sealant For Gap/Screws



## PVC Cap For SDT Screw :

This is required as an added safety to prevent leakage. these are available in different colors. pvc cap for "J", "L" pipe bolts and pp cap for sdt screws are available for sale.



## Louvers



# ■ ■ ■ ■ Accessories – Other Miscellaneous Products

PVC Curtains



PVC Roof Sheets

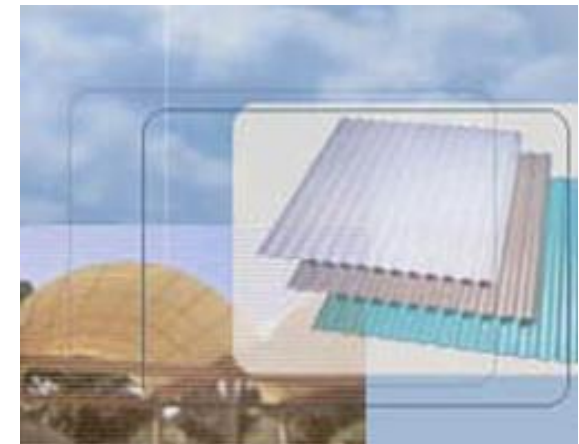
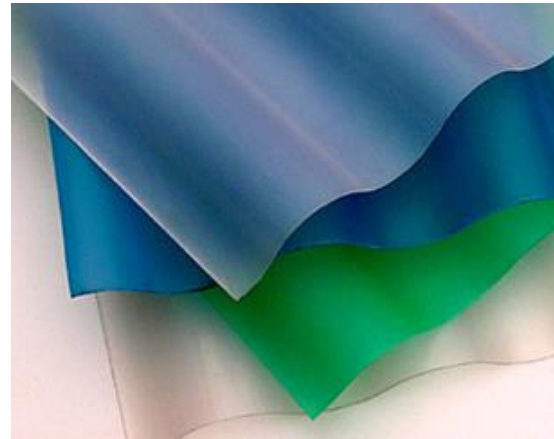

# Other Roofing Products – Perforated Metal Sheet

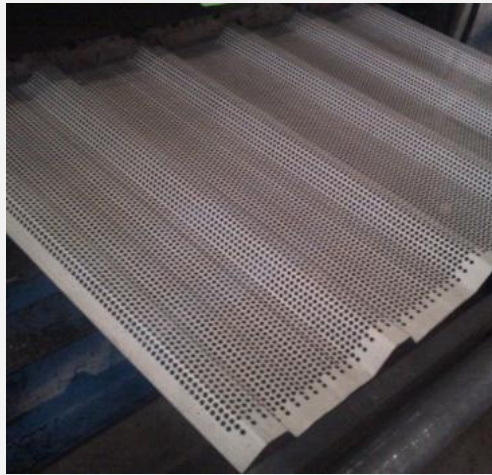

Perforated metal Sheet is made through the metal stamping and manufacturing process. This is a sheet or plate with round holes punched in it or expanded metal.

Perforated materials are very versatile. From lightweight decorative elements to load-bearing structural components, perforated metal offers unique opportunities to combine strength, functionality and beauty. Perforated Sheet are also an excellent means of achieving sustainable design objectives.

Perforated sunshades and sunscreens provide privacy for building occupants without blocking the view. And they offer a comfortable level of natural lighting during daylight hours while deflecting heat to reduce the load on the HVAC system. Perforated canopies, facades and cladding can also be used to help control interior climate and save energy

## Benefits :

Perforated materials have many advantages ranging from weight reduction through acoustic noise reduction to heat dissipation and much more.

1. Acoustic performance
2. Weight reduction
3. Radiation containment
4. Separation
5. Heat dissipation
6. Transparency
7. Anti-Skid

## Applications :

1. Interior Design
2. HVAC
3. Noise Control
4. Security Ceilings
5. Sunscreens
6. Building Facades
7. In-Fill Panels
8. Ceilings
9. Furnishings
10. Stair Treads and Risers
11. Screening and Fencing



# Other Roofing Products – Polycarbonate & FRP Sheet



## Polycarbonate Sheet

BRPL offers Polycarbonate sheet in a wide range of thicknesses and colours as well as in flat sheets, embossed, corrugated and multiwall

- 1. Clear Compact:** These are light weights, strong flat sheets in different thicknesses. Transparency is like glass. It is very strong and available from 1.5 mm. to 20 mm. thickness.
- 2. Multiwall:** The product is light, strong, insulating and attractive. Being used widely for roofing, cladding and other applications. It is available in twin wall, triple wall, and multiple wall. It is cost effective and beautiful look wise.
- 3. Embossed:** These are plain sheets comes in a regular, prismatic embossing feature in different thicknesses ranging from 2 mm. to 20 mm.
- 4. Corrugated:** Cement corrugation, Grecca, Sinus, Treford and any other profile. Grecca is available in translucent, transparent, opaque colours. Other sheets are available in natural transparent colours and are suitable for skylighting.



## FRP Sheet

BRPL offers fiber glass Opaque and Translucent sheets for different applications. Product offered are U.V. Stabilized, Superior Impact Resistance , Better finish since it is made out of First Quality chopped glass mat and U.V. Polyester resin

### Product Range :

1. Translucent and Opaque –
  - a. Plain sheet with and without wrinkle.
  - b. Corrugated sheet in any Profile (GI, Precoated, PVC, Aluminium etc.)
  - c. Multi Coloured sheets
  - d. Textile Sheets
2. Translucent and Opaque - Domes and Pyramid
3. Any thickness between 0.8 mm to 10 mm.

### Applications :

1. Translucent sheets provide natural daylight in Industrial and Domestic sheds. Light transmission is 40% to 90%.
2. Translucent sheets can be used as :
  - a. Side Cladding Sheets, instead of glass, on main gate of house, shower partitions.
  - b. Decorative False Ceiling
  - c. Skylight area (OTS), Green House.
  - d. Canopy, Car Parking Sheds



# Other Roofing Products – Metal Deck Sheet

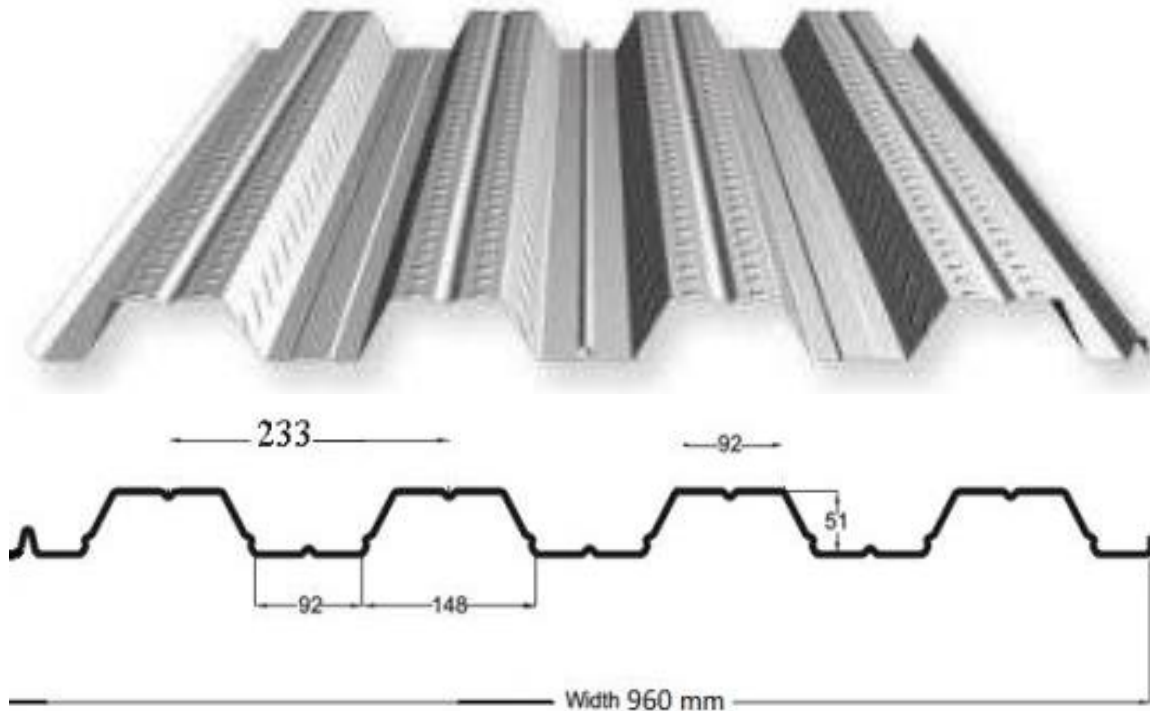

1. **Greater Durability:** The Bansal Deck Steel base has superior corrosion protection with guaranteed minimum yield strength depending on the specification used.
2. **Unbeatable strength:** When the steel and concrete composite slabs are constructed, they are lighter and stronger than most conventional slabs. Steel Decking provides flexible reinforcement, combined with the compressive strength of the concrete, for an all round stronger slab. The steel decking profiles are designed to inhibit any longitudinal slip between the steel and concrete in the slab itself, and any transverse movement between the slab and the supporting beams.
3. **Easy on-site handling:** Steel decking is transported to site in pre-cut lengths, and in pre-packaged bundles. These bundles can be easily craned into specific work areas, and the individual sheets quickly laid by hand
4. **Speedy, safe construction:** One advantage of metal deck steel floorings its speedy erection

# Other Roofing Products – ‘Z’ and ‘C’ Purlins

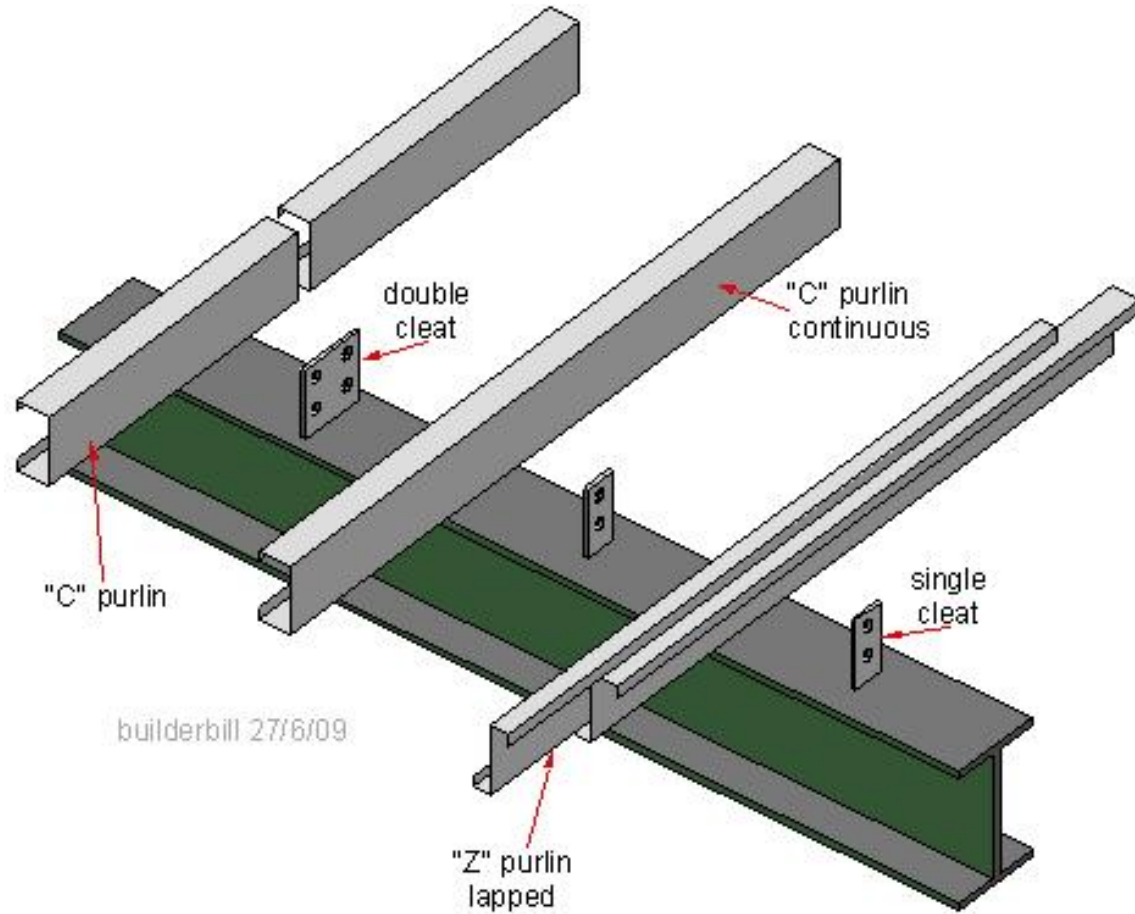

1. These purlins are most unique cold roll formed sections used to fix roof and side claddings.
2. The advantage of using these purlins are unlimited depth and thickness option gives the designer the required freedom to design most economical purlin.
3. Minimum yield strength of these purlins will be 320 Mpa which enables designer to design light weight purlin.
4. 'Z' purlins can be supplied from 85 mm depth to 360 mm depth and thickness of 1.8 mm to 4 mm.
5. 'C' purlins can be supplied from 50 mm depth to 500 mm depth and thickness 1.8mm to 4 mm

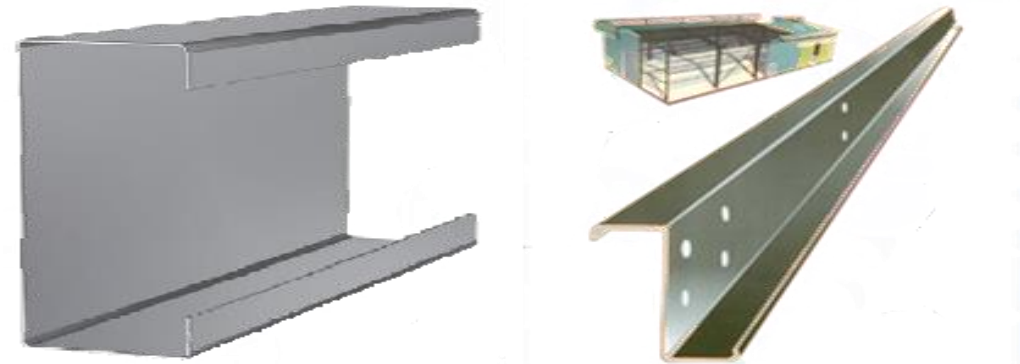

# Other Roofing Products – Eco Ventilators



BRPL offers Turbo ventilator is a self driven equipment installed on industrial roofs to extract inside air. Turbo ventilators are driven by wind hence no electricity or other power sources are required. As the ventilator is rotated by wind, the stale inside air is exhausted through it natural inward flow of fresh air is boosted.

The turbo ventilator operates by utilizing the velocity of the wind to induce air flow by centrifugal action. The centrifugal force caused by the spinning vanes creates a region of low pressure area which draws air out through the vanes. Air drawn out by the vanes is continuously replaced by fresh air from the outside. The slightest breeze will cause the turbine to spin and even after the breeze has stopped, the flywheel effect of the rotor cage will use its stored energy to continuously remove air giving rise to ventilation. Suction is maintained even at low wind velocities.



## Features

1. Rigid roll formed curved vanes in aluminium. optional S.S. 304 vanes are also available.
2. Rotor shaft & nylon bush assembly concealed in mild steel casting
3. Light weight & durable. approximately 6.5 to 7 kg. Audit.
4. Top plate & bottom ring is made of stainless steel.
5. Single piece U.V. stabilised FRP base plate in different thickness. option of opaque and translucent available.
6. Virtually maintenance free, weatherproof and storm proof.

# Pre-engineering Structures



Bansal Roofing Products Ltd. Is all set to produce pre engineering buildings as per clients requirements. The company has all the latest machineries to support this segment

Pre engineering building is a concept structure having high structural strength, economical designs while it supersedes the conventional fabrication, it lower down the stress of foundation, hence less cost on civil construction as well



## Applications :

1. Factory
2. Warehouse
3. Workshop
4. Community hall
5. Commercial showrooms



# Industry Overview





# The Indian Opportunity



## Iron/ Steel & Steel Structures

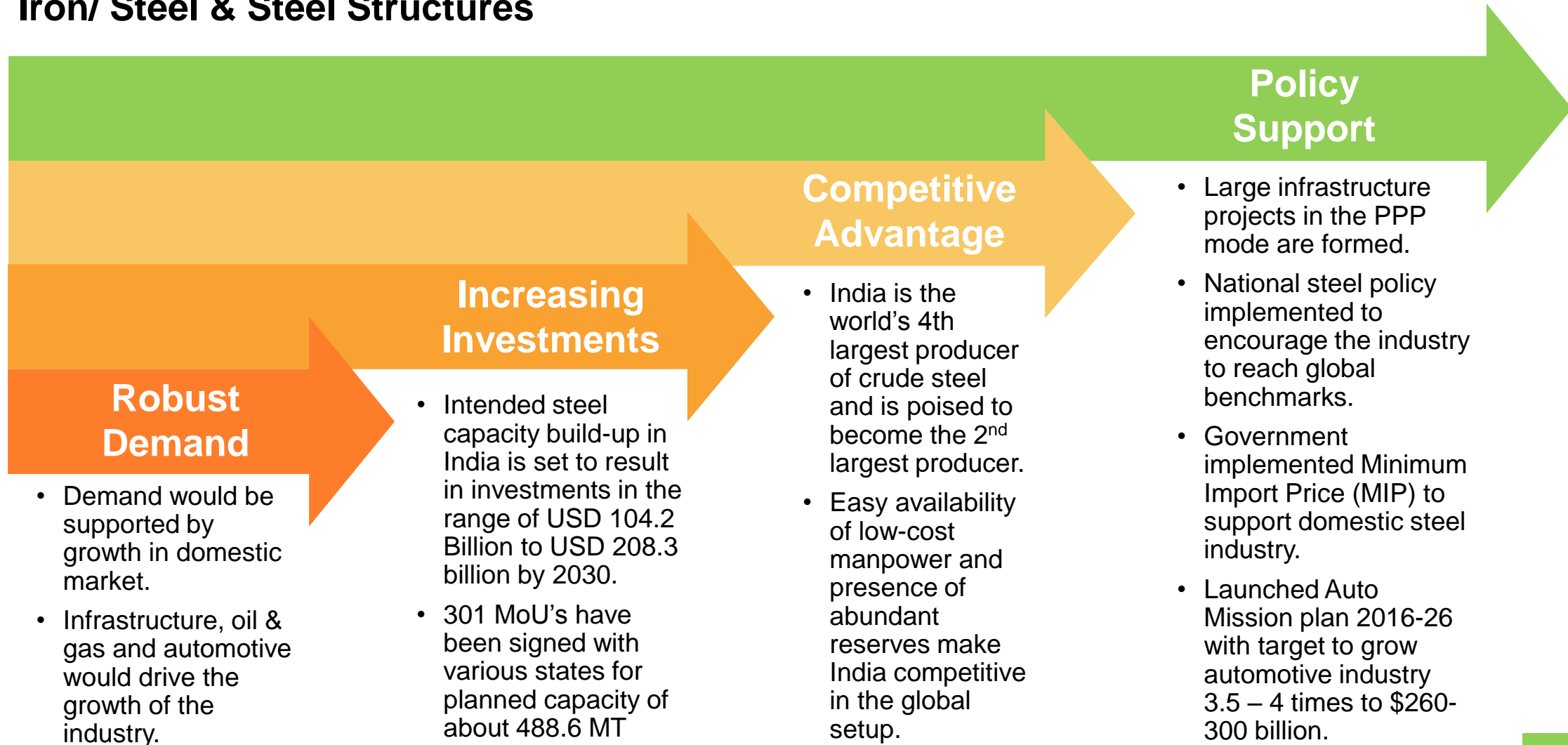

# Industry Overview – Pre Engineering Structures

- PEBs are eco-friendly as its components are manufactured from cold formed sheet steel, as it is one of the world's most recycled material, therefore, depending on the manufacturing process, close to 95% of the components of a newly manufactured steel product can be recycled also the end of any steel product's life, almost 100% of it can be recycled without losing its engineering properties, making PEB technology one of the greenest construction methods.
- PEBs use skylights and solar panels on rooftops to meet the daylight and captive power requirements ,they help to reduce emissions and gain carbon credits unlike the conventional methods for powering the building.
- One of the emerging trends spurring the growth prospects for this market is the increasing demand for warehouses with a rise in the number of e-retailers, the demand for warehouses is also increasing. During 2015, online sales accounted for 7.5% of the total retail sales globally and will reach 13% by 2020.
- PEBs offer the fastest method to build warehouses compared to traditional methods, its demand among the end users will increase over the next four years.



## Geographical segmentation and analysis of the PEBs market

- APAC
- Europe
- North America
- ROW
- In terms of geography, North America dominated the market and is expected to reach close to USD 5 billion by 2020.

## Growth drivers, challenges, and upcoming trends: Smart Cities

- Upcoming trends such as the development of smart cities in India is gaining popularity as they are highly advanced in terms of sustainable real estate, infrastructure, communication technology, and market viability.
- Moreover, in these cities, IT, automated sensor networks, and data centres will constitute the central infrastructure to provide the residents with all the essential services.



# Industry Overview – Roofing Products



- The total market size of steel roofing industry is approximately 1 mn tonne.
- The Indian market has witnessed a major shift from asbestos and galvanized steel sheets to Zn-Al coated sheets. Zn-Al coated sheet provides excellent atmospheric resistance in a wide range of environment under many diverse conditions.
- Roofing industry has witnessed a paradigm shift in the last few years. With increased investment in infrastructure projects, customers are demanding durability, flexibility along with aesthetically pleasing designs.

## New trends in roofing market

- Roofing industry in India is preparing for the next generation of ambitious projects.
- Growth in the infrastructure and industrial segment has been a major demand driver for roof and wall cladding industry. It has registered a double digit growth over past three years.
- Major shift is observed from clay tiles and conventional roofing system to metal cladding solution.
- Customers are looking for architectural solution which provides innovative shapes such as convex, concave in addition to new attractive colours.
- The future of roof and wall cladding industry is bright considering the low steel penetration and high demand in construction industry.

## Growth Drivers

- Aesthetics, superior technology, durability, thermal efficiency are some of the significant driving factors for Zn-Al coated sheets. Performance of 150 GSM Zn-Al coated material is four times longer than 275 GSM Zn coated material.

# Financial Overview



# Income Statement



PARTICULARS (INR MN.)	FY14	FY15	FY16
<b>Total Revenue</b>	<b>192</b>	<b>245</b>	<b>225</b>
Total Expenses	181	234	211
<b>EBITDA</b>	<b>11</b>	<b>11</b>	<b>14</b>
<b>EBITDA Margins (%)</b>	<b>5.73%</b>	<b>4.49%</b>	<b>6.22%</b>
Depreciation	1	2	2
Finance Cost	1	1	2
PBT	9	7	9
Tax	3	2	3
<b>PAT</b>	<b>6</b>	<b>5</b>	<b>6</b>
<b>PAT Margins (%)</b>	<b>3.13%</b>	<b>2.04%</b>	<b>2.68%</b>
Diluted EPS	4.35	2.39	2.93

# Balance Sheet

PARTICULARS (INR Mn)	FY14	FY15	FY16	PARTICULARS (INR Mn)	FY14	FY15	FY16
<b>EQUITIES &amp; LIABILITIES</b>				<b>ASSETS</b>			
<b>Shareholder Funds</b>				<b>Non-current Assets</b>			
(A) Share Capital	15.2	22.0	22.0	(A) Fixed Assets			
(B) Reserves & Surplus	7.3	25.7	32.1	Tangible Assets	16.4	20.3	32.4
<b>Non-current Liabilities</b>				(B) Other Non Current Assets	1.7	4.2	3.1
(A) Long-term Borrowings	8.2	5.4	9.9	<b>Current Assets</b>			
(B) Deferred Tax Liabilities	0.9	1.0	1.3	(A) Inventories	41.0	42.8	32.7
<b>Current Liabilities</b>				(B) Trade Receivables	5.0	10.9	14.0
(A) Short term Borrowings	8.8	15.8	25.2	(C) Deposits	0.0	0.2	0.0
(B) Trade Payables	24.0	10.0	4.7	(D) Cash & Bank Balances	1.3	1.5	4.2
(C) Other Current Liabilities	4.2	5.1	4.3	(E) Short-term loans & advances	2.6	5.6	4.3
(D) Short-term provisions	0.5	1.0	0.9	(F) Other Current Assets	1.0	0.5	9.7
<b>GRAND TOTAL - EQUITIES &amp; LIABILITES</b>	<b>69</b>	<b>86</b>	<b>100</b>	<b>GRAND TOTAL – ASSETS</b>	<b>69</b>	<b>86</b>	<b>100</b>

# Financial Overview – Financial Charts



### Total Revenue (INR Mn)

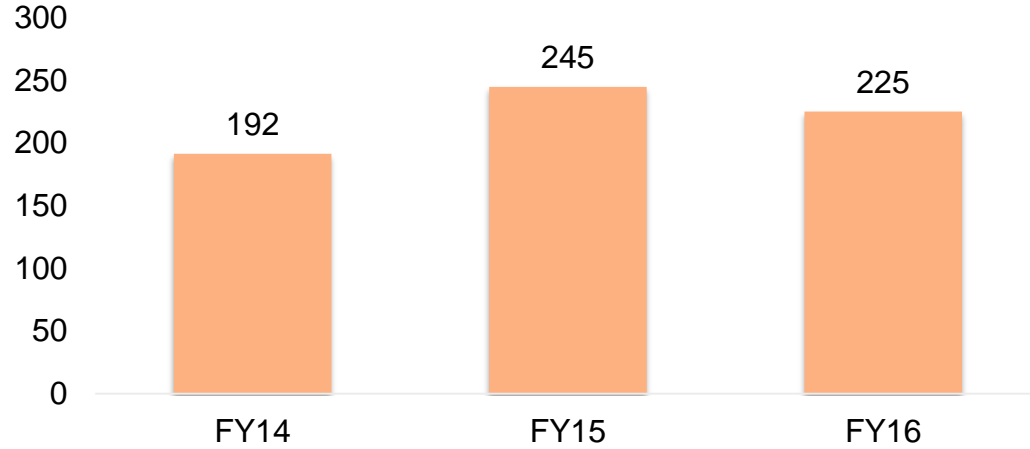

### EBITDA (INR Mn)

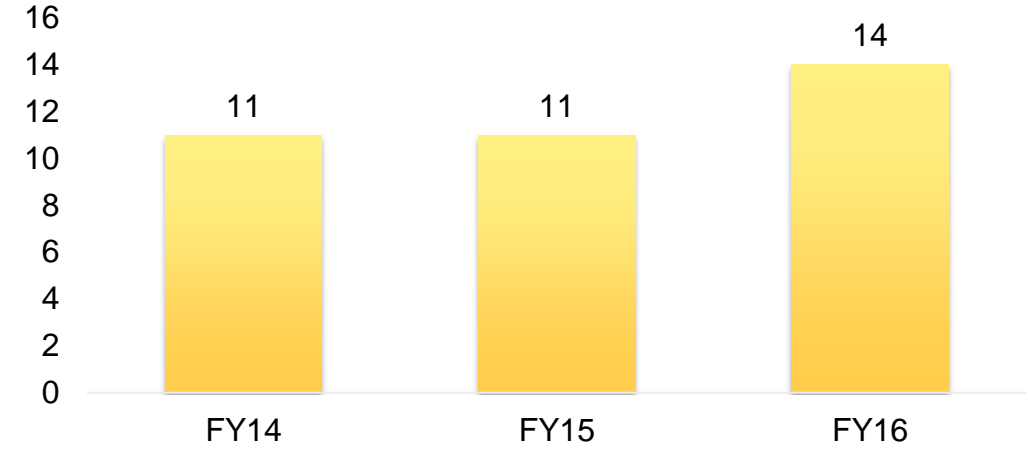

### PAT (INR Mn)

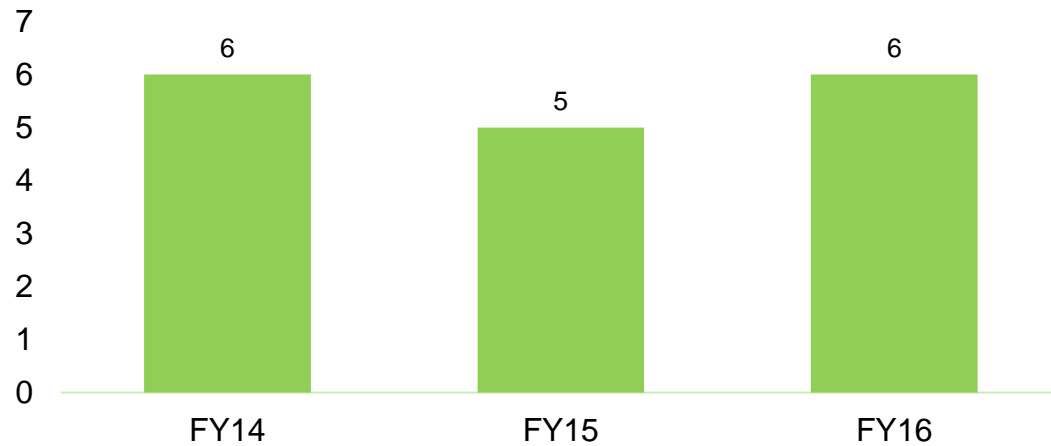

### Net Worth (INR Mn)

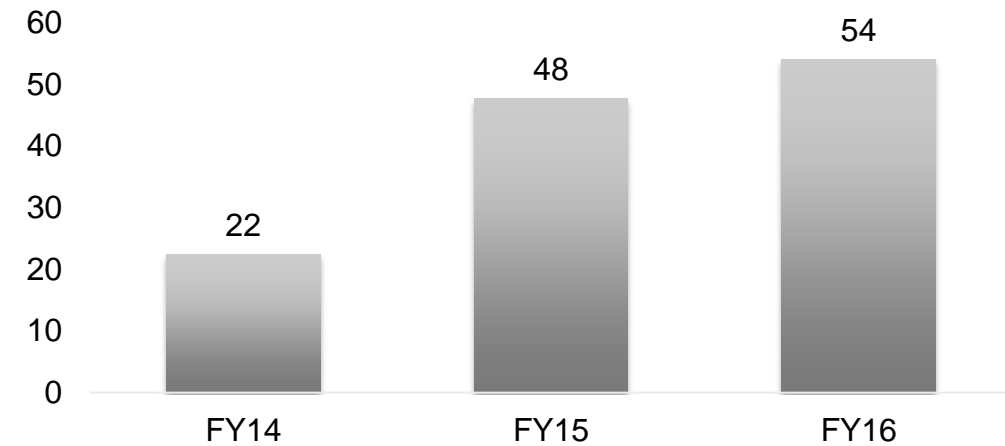

# **DISCLAIMER**



No representation or warranty, express or implied, is made as to, and no reliance should be placed on, the fairness, accuracy, completeness or correctness of the information or opinions contained in this presentation. Such information and opinions are in all events not current after the date of this presentation. Certain statements made in this presentation may not be based on historical information or facts and may be "forward looking statements" based on the currently held beliefs and assumptions of the management Bansal Roofing Products Limited ("Company" or "BRPL" or "Bansal Roofing Products Ltd."), which are expressed in good faith and in their opinion reasonable, including those relating to the Company's general business plans and strategy, its future financial condition and growth prospects and future developments in its industry and its competitive and regulatory environment.

Forward-looking statements involve known and unknown risks, uncertainties and other factors, which may cause the actual results, financial condition, performance or achievements of the Company or industry results to differ materially from the results, financial condition, performance or achievements expressed or implied by such forward-looking statements, including future changes or developments in the Company's business, its competitive environment and political, economic, legal and social conditions. Further, past performance is not necessarily indicative of future results. Given these risks, uncertainties and other factors, viewers of this presentation are cautioned not to place undue reliance on these forward-looking statements. The Company disclaims any obligation to update these forward-looking statements to reflect future events or developments.

This presentation is for general information purposes only, without regard to any specific objectives, financial situations or informational needs of any particular person. This presentation does not constitute an offer or invitation to purchase or subscribe for any securities in any jurisdiction, including the United States. No part of it should form the basis of or be relied upon in connection with any investment decision or any contract or commitment to purchase or subscribe for any securities. None of our securities may be offered or sold in the United States, without registration under the U.S. Securities Act of 1933, as amended, or pursuant to an exemption from registration there from.

This presentation is confidential and may not be copied or disseminated, in whole or in part, and in any manner.

#### Valorem Advisors Disclaimer:

Valorem Advisors is an Independent Investor Relations Management Service company. This Presentation has been prepared by Valorem Advisors based on information and data which the Company considers reliable, but Valorem Advisors and the Company makes no representation or warranty, express or implied, whatsoever, and no reliance shall be placed on, the truth, accuracy, completeness, fairness and reasonableness of the contents of this Presentation. This Presentation may not be all inclusive and may not contain all of the information that you may consider material. Any liability in respect of the contents of, or any omission from, this Presentation is expressly excluded. Valorem Advisors also hereby certifies that the directors or employees of Valorem Advisors do not own any stock in personal or company capacity of the Company under review.



**For further information please contact our Investor Relations Representatives:**

**Valorem Advisors**

**Mr. Prasanna Pathak/Mr. Chintan Kotak**

Tel: +91-22 3006-7521/22/23/24

Email: [bansal@valoremadvisors.com](mailto:bansal@valoremadvisors.com)

**Thank You**

