



## EP BIOCOMPOSITES LIMITED

Corporate Identity Number is U28900GA2020PLC014240.

REGISTERED OFFICE	CONTACT PERSON	EMAIL AND TELEPHONE	WEBSITE
C/o OM Ventures, Shed No D-2/12, Bicholim Industrial Estate, Bicholim, Goa – 403504	Faiyazul Haq <i>Company Secretary and Compliance Officer.</i>	<b>Email:</b> <a href="mailto:info@epkamatgroup.com">info@epkamatgroup.com</a> <b>Telephone:</b> +91-832-2431081/ +91-9158005202	<a href="http://www.epbiocomposites.com">www.epbiocomposites.com</a>
THE PROMOTERS OF OUR COMPANY			
Leena Kamat and Rajkumar Kamat			
DETAILS OF ISSUE			
Initial Public Offer Of 5,04,000 Equity Shares Of ₹ 10 Each (“Equity Shares”) Of ₹ 10 Each (“Equity Shares”) At A Price Of ₹ 126 Per Share (The “Issue Price”), Aggregating To ₹ 635.04 Lakhs (“The Issue”)			
RISK IN RELATION TO THE FIRST ISSUE			
This being the first Public Issue of our Company, there has been no formal market for the Equity Shares of our Company. The face value of the Equity Shares is ₹ 10 each and the Issue Price is 12.60 times the face value. The Issue Price (determined and justified by our Company in consultation with the Lead Manager) as stated under “Basis for Issue Price” beginning on page no. 61 of this Prospectus should not be taken to be indicative of the market price of the Equity Shares after the Equity Shares are listed. No assurance can be given regarding an active or sustained trading in the Equity Shares or regarding the price at which the Equity Shares will be traded after listing.			
GENERAL RISK			
Investment in equity and equity-related securities involve a degree of risk and investors should not invest any funds in the Issue unless they can afford to take the risk of losing their investment. Investors are advised to read the risk factors carefully before taking an investment decision in the Issue. For taking an investment decision, investors must rely on their own examination of our Company and the Issue, including the risks involved. The Equity Shares in the Issue have not been recommended or approved by the Securities and Exchange Board of India (“SEBI”), nor does SEBI guarantee the accuracy or adequacy of the contents of this Prospectus. Specific attention of the investors is invited to “Risk Factors” beginning on page no. 19 of this Prospectus.			
COMPANY’S ABSOLUTE RESPONSIBILITY			
Our Company, having made all reasonable inquiries, accepts responsibility for and confirms that this Prospectus contains all information with regard to our Company and the Issue, which is material in the context of the Issue, that the information contained in this Prospectus is true and correct in all material aspects and is not misleading in any material respect, that the opinions and intentions expressed herein are honestly held and that there are no other facts, the omission of which makes this Prospectus as a whole or any of such information or the expression of any such opinions or intentions misleading in any material respect.			
LISTING			
The Equity Shares issued through this Prospectus are proposed to be listed on SME Platform of BSE Limited (“BSE”). Our Company has received an In-Principle Approval letter dated March 10, 2022 from BSE Limited for using its name in this Offer Document for listing our shares on the SME Platform of BSE Limited. For the purpose of this Issue, the Designated Stock Exchange will be the BSE Limited (“BSE”).			
LEAD MANAGER TO THE ISSUE		REGISTRAR TO THE ISSUE	
 <b>ARYAMAN</b> FINANCIAL SERVICES LTD			
<b>ARYAMAN FINANCIAL SERVICES LIMITED</b> 60, Khatau Building, Ground Floor, Alkesh Dinesh Modi Marg, Fort, Mumbai – 400 001. <b>Tel:</b> +91 – 22 – 6216 6999 <b>Email:</b> <a href="mailto:ipo@afsl.co.in">ipo@afsl.co.in</a> <b>Website:</b> <a href="http://www.afsl.co.in">www.afsl.co.in</a> <b>Investor Grievance Email:</b> <a href="mailto:feedback@afsl.co.in">feedback@afsl.co.in</a> <b>Contact Person:</b> Vatsal Ganatra <b>SEBI Registration No.:</b> INM000011344		<b>BIGSHARE SERVICES PRIVATE LIMITED</b> Office No. S6-2, 6th Floor, Pinnacle Business Park, Mahakali Caves Road, Next to Ahura Centre. Andheri (East), Mumbai - 400 093 <b>Tel. No.:</b> +91 22 6263 8200 <b>Email:</b> <a href="mailto:ipo@bigshareonline.com">ipo@bigshareonline.com</a> <b>Website:</b> <a href="http://www.bigshareonline.com">www.bigshareonline.com</a> <b>Investor Grievance Email:</b> <a href="mailto:investor@bigshareonline.com">investor@bigshareonline.com</a> <b>Contact Person:</b> Babu Rapheal <b>SEBI Registration No.:</b> INR000001385	
ISSUE OPENS ON		ISSUE CLOSES ON	
August 29, 2022		September 05, 2022	



## EP BIOCOMPOSITES LIMITED

Our Company was incorporated as “EP Biocomposites Limited” on January 17, 2020 under the Companies Act, 2013 with the Registrar of Companies, Goa Registration No.014240. A certificate of incorporation was issued on January 17, 2020 by the Registrar of Companies, Goa. The Company’s Corporate Identity Number is U28900GA2020PLC014240. For further details pertaining to the change of name of our Company and the change in Registered Office, please refer the chapter “History and Certain Corporate Matters” on page no. 98 of this Prospectus.

**Registered Office:** C/o OM Ventures, Shed No D-2/12, Bicholim Industrial Estate, Bicholim, Goa – 403504

**Corporate Office:** 1<sup>st</sup> Floor, B.R. Commercial Centre, Opp. Parade Ground, Campal, Panaji, Goa-403001

**Tel No.:** +91-832-2431081/+91-9158005202

**Email:** [info@epkamatgroup.com](mailto:info@epkamatgroup.com); **Website:** [www.epbiocomposites.com](http://www.epbiocomposites.com)

**Contact Person:** Mohammad Faiyazul Haq, Company Secretary and Compliance Officer

**Our Promoters:** Leena Kamat and Rajkumar Kamat

### THE ISSUE

**INITIAL PUBLIC OFFER OF 5,04,000 EQUITY SHARES OF ₹ 10 EACH (“EQUITY SHARES”) OF EP BIOCOMPOSITES LIMITED (“EBL” OR THE “COMPANY”) FOR CASH AT A PRICE OF ₹ 126 PER SHARE (THE “ISSUE PRICE”), AGGREGATING TO ₹ 635.04 LAKHS (“THE ISSUE”), OF WHICH 28,000 EQUITY SHARES OF ₹10 EACH WILL BE RESERVED FOR SUBSCRIPTION BY MARKET MAKER TO THE ISSUE (THE “MARKET MAKER RESERVATION PORTION”). THE ISSUE LESS MARKET MAKER RESERVATION PORTION I.E. ISSUE OF 4,76,000 EQUITY SHARES OF ₹ 10 EACH IS HEREINAFTER REFERRED TO AS THE “NET ISSUE”. THE ISSUE AND THE NET ISSUE WILL CONSTITUTE 30.02% AND 28.35%, RESPECTIVELY OF THE POST ISSUE PAID UP EQUITY SHARE CAPITAL OF THE COMPANY.**

**THE FACE VALUE OF THE EQUITY SHARE IS ₹ 10 AND THE ISSUE PRICE IS 12.60 TIMES OF THE FACE VALUE**

In terms of Rule 19(2) (b) (i) of the SCRR this Issue is being made for at least 25% of the post-Issue paid-up Equity Share capital of our Company. This Issue is being made through Fixed Price process in accordance and compliance with Chapter IX and other applicable provisions of SEBI ICDR Regulations wherein a minimum 50% of the Net Issue is allocated for Retail Individual Applicants and the balance shall be offered to individual applicants other than Retail Individual Applicants and other investors including corporate bodies or institutions, QIBs and Non-Institutional Applicants. However, if the aggregate demand from the Retail Individual Applicants is less than 50%, then the balance Equity Shares in that portion will be added to the non-retail portion offered to the remaining investors including QIBs and NIIs and vice-versa subject to valid Applications being received from them at or above the Issue Price. Additionally, if the Retail Individual Applicants category is entitled to more than fifty per cent on proportionate basis, the Retail Individual Applicants shall be allocated that higher percentage.

All potential investors shall participate in the Issue only through an Application Supported by Blocked Amount (“ASBA”) process including through UPI mode (as applicable) by providing details of the respective bank accounts and / or UPI IDs, if applicable, which will be blocked by the Self Certified Syndicate Banks (“SCSBs”) for the same. For details in this regard, specific attention is invited to “Issue Procedure” on page no. 179 of this Prospectus. A copy has been filed with the Registrar of Companies as required under Section 26 of the Companies Act, 2013.

### RISK IN RELATION TO THE FIRST ISSUE

This being the first Public Issue of our Company, there has been no formal market for the Equity Shares of our Company. The face value of the Equity Shares is ₹ 10 each and the Issue Price is 12.60 times the face value. The Issue Price (determined and justified by our Company in consultation with the Lead Manager) as stated under “Basis for Issue Price” beginning on page no. 61 of this Prospectus should not be taken to be indicative of the market price of the Equity Shares after the Equity Shares are listed. No assurance can be given regarding an active or sustained trading in the Equity Shares or regarding the price at which the Equity Shares will be traded after listing.

### GENERAL RISKS

Investment in equity and equity-related securities involve a degree of risk and investors should not invest any funds in the Issue unless they can afford to take the risk of losing their investment. Investors are advised to read the risk factors carefully before taking an investment decision in the Issue. For taking an investment decision, investors must rely on their own examination of our Company and the Issue, including the risks involved. The Equity Shares in the Issue have not been recommended or approved by the Securities and Exchange Board of India (“SEBI”), nor does SEBI guarantee the accuracy or adequacy of the contents of this Prospectus. Specific attention of the investors is invited to “Risk Factors” beginning on page no. 19 of this Prospectus.

### COMPANY’S ABSOLUTE RESPONSIBILITY

Our Company, having made all reasonable inquiries, accepts responsibility for and confirms that this Prospectus contains all information with regard to our Company and the Issue, which is material in the context of the Issue, that the information contained in this Prospectus is true and correct in all material aspects and is not misleading in any material respect, that the opinions and intentions expressed herein are honestly held and that there are no other facts, the omission of which makes this Prospectus as a whole or any of such information or the expression of any such opinions or intentions misleading in any material respect.

### LISTING

The Equity Shares issued through this Prospectus are proposed to be listed on SME Platform of BSE Limited (“BSE”). Our Company has received an In-Principle Approval letter dated March 10, 2022 from BSE Limited for using its name in this Offer Document for listing our shares on the SME Platform of BSE Limited. For the purpose of this Issue, the Designated Stock Exchange will be the BSE Limited (“BSE”).

#### LEAD MANAGER TO THE ISSUE



**ARYAMAN FINANCIAL SERVICES LIMITED**  
60, Khatau Building, Ground Floor, Alkesh Dinesh Modi Marg  
Fort, Mumbai – 400 001  
**Tel No.:** +91 22 6216 6999  
**Email:** [ipo@afsl.co.in](mailto:ipo@afsl.co.in)  
**Website:** [www.afsl.co.in](http://www.afsl.co.in)  
**Investor Grievance Email:** [feedback@afsl.co.in](mailto:feedback@afsl.co.in)  
**Contact Person:** Vatsal Ganatra  
**SEBI Registration No.** INM000011344

#### REGISTRAR TO THE ISSUE



**BIGSHARE SERVICES PRIVATE LIMITED**  
Office No. S6-2, 6th Floor, Pinnacle Business Park, Mahakali Caves Road, Next to Ahura Centre, Andheri (East), Mumbai - 400 093  
**Tel. No.:** +91 22 6263 8200  
**Email:** [ipo@bigshareonline.com](mailto:ipo@bigshareonline.com)  
**Website:** [www.bigshareonline.com](http://www.bigshareonline.com)  
**Investor Grievance Email:** [investor@bigshareonline.com](mailto:investor@bigshareonline.com)  
**Contact Person:** Babu Rapheal  
**SEBI Registration No.:** INR000001385

#### ISSUE OPENS ON

**August 29, 2022**

#### ISSUE CLOSES ON

**September 05, 2022**

## TABLE OF CONTENTS

<b>SECTION I – GENERAL</b> .....	<b>1</b>
DEFINITIONS AND ABBREVIATIONS.....	1
CERTAIN CONVENTIONS; PRESENTATION OF FINANCIAL INDUSTRY AND MARKET DATA.....	12
FORWARD-LOOKING STATEMENTS.....	14
<b>SECTION II – SUMMARY OF OFFER DOCUMENT</b> .....	<b>16</b>
<b>SECTION III – RISK FACTORS</b> .....	<b>19</b>
<b>SECTION IV – INTRODUCTION</b> .....	<b>35</b>
THE ISSUE .....	35
SUMMARY OF FINANCIAL INFORMATION .....	36
GENERAL INFORMATION .....	39
CAPITAL STRUCTURE .....	48
OBJECTS OF THE ISSUE.....	56
BASIS OF ISSUE PRICE.....	61
STATEMENT OF TAX BENEFITS.....	63
<b>SECTION VI – ABOUT OUR COMPANY</b> .....	<b>66</b>
INDUSTRY OVERVIEW .....	66
OUR BUSINESS .....	72
KEY INDUSTRY REGULATIONS AND POLICIES .....	92
HISTORY AND CERTAIN CORPORATE MATTERS .....	98
OUR MANAGEMENT .....	101
OUR PROMOTER AND PROMOTER GROUP .....	113
OUR GROUP COMPANIES.....	117
DIVIDEND POLICY .....	120
<b>SECTION VII – FINANCIAL INFORMATION</b> .....	<b>121</b>
FINANCIAL STATEMENTS .....	121
MANAGEMENT DISCUSSION AND ANALYSIS OF FINANCIAL CONDITION AND RESULTS OF OPERATION.....	141
FINANCIAL INDEBTEDNESS.....	151
<b>SECTION VII – LEGAL AND OTHER REGULATORY INFORMATION</b> .....	<b>152</b>
OUTSTANDING LITIGATIONS AND MATERIAL DEVELOPMENTS.....	152
GOVERNMENT AND OTHER KEY APPROVALS .....	157
<b>SECTION IX – OTHER REGULATORY AND STATUTORY DISCLOSURES</b> .....	<b>160</b>
<b>SECTION X – ISSUE INFORMATION</b> .....	<b>170</b>
TERMS OF THE ISSUE.....	170
ISSUE STRUCTURE.....	176
ISSUE PROCEDURE .....	179
RESTRICTIONS ON FOREIGN OWNERSHIP OF INDIAN SECURITIES .....	198
<b>SECTION XI – MAIN PROVISIONS OF ARTICLES OF ASSOCIATION</b> .....	<b>199</b>
<b>SECTION XII – OTHER INFORMATION</b> .....	<b>212</b>
MATERIAL CONTRACTS AND DOCUMENTS FOR INSPECTION .....	212
DECLARATION .....	213

## SECTION I – GENERAL

### DEFINITIONS AND ABBREVIATIONS

This Prospectus uses certain definitions and abbreviations which, unless the context otherwise indicates or implies, shall have the meaning as provided below. References to any legislation, act, regulation, rule, guideline or policy shall be to such legislation, act, regulation, rule, guideline or policy, as amended, supplemented or re-enacted from time to time.

The words and expressions used in this Prospectus but not defined herein shall have, to the extent applicable, the meaning ascribed to such terms under the Companies Act, the SEBI ICDR Regulations, the SCRA, the Depositories Act or the rules and regulations made there under. If there is any inconsistency between the definitions given below and the definitions contained in the General Information Document (defined hereinafter), the following definitions shall prevail.

#### General Terms

Term	Description
EP Biocomposites Limited / EPBL/ “The Company”, “Our Company” or “The Issuer”	Unless the context otherwise indicates or implies refers to EP Biocomposites Limited, a company incorporated under the Companies Act, 2013 and having its Registered office at: C/O OM Ventures, Shed No D-2/12, Bicholim Industrial Estate, Bicholim, Goa – 403504.
“we”, “us” or “our”	Unless the context otherwise indicates or implies, refers to our Company.
“you”, “your”, or “yours”	Prospective Investor in this issue

#### Company related Terms

Term	Description
AoA/ Articles / Articles of Association	The articles of association of our Company, as amended from time to time
Auditor / Statutory Auditor	The Statutory Auditors of our Company, being M/s. S.P. Bhandare & Associates., Chartered Accountants, (FRN: 101157W) having their office at 3/UG-4, Models Residency, St. Inez, Panaji, Goa- 403001.
Audit Committee	The audit committee of our Company constituted on April 28, 2020 in accordance with Section 177 of the Companies Act, 2013, as described in “Our Management” page no.98 of this Prospectus
Board of Directors / Board	The Board of Directors of EP Biocomposites Limited, including all duly constituted Committees thereof.
Chief Financial Officer	Chief Financial Officer of our Company is Nilam Naresh Kadkade
Company Secretary and Compliance Officer	The Company Secretary and Compliance officer of our Company is Mohammad Faiyazul Haq
Corporate Office	1 <sup>st</sup> Floor, B.R. Commercial Centre, Opp. Parade Ground, Campal, Panaji, Goa-403001
CIN/ Corporate Identification Number	U28900GA2020PLC014240
Director(s)	Director(s) of EP Biocomposites Limited, unless otherwise specified.
Executive Directors	Executive Directors are the Managing Director & Whole Time Directors of our Company.
EPBL	EP Biocomposites Limited
Equity Shares	Equity Shares of our Company of Face Value of ₹ 10 each unless otherwise specified in the context thereof.
Equity Shareholders	Persons holding Equity Share of our Company
Group Companies	In terms of SEBI ICDR Regulations, the term “Group Companies” includes companies (other than our Promoter) with which there were related party transactions as disclosed in the Restated Financial Statements as covered under the applicable accounting standards, and any other companies as considered material by our Board, in accordance with the Materiality Policy, as described in “Our Group Companies” on page no.117 of this Prospectus.
Independent Director(s)	The Independent Director(s) of our Company, in terms of Section 2(47) and Section 149(6) of the Companies Act, 2013

<b>Term</b>	<b>Description</b>
ISIN	International Securities Identification Number. In this case being INE0D2I01014.
Key Management Personnel / KMP	Key managerial personnel of our Company in terms of Regulation 2(1)(bb) of the SEBI (ICDR) Regulations, together with the Key Managerial Personnel of our Company in terms of Section 2(51) of the Companies Act, 2013 and as disclosed in the chapter titled “Our Management” on page no.98 of this Prospectus
Materiality Policy	The policy adopted by our Board on January 11, 2022 for identification of Group Companies, material outstanding litigation and outstanding dues to material creditors, in accordance with the disclosure requirements under the SEBI ICDR Regulations
MD or Managing Director	The Managing Director of our Company being Rajkumar Kamat
MOA / Memorandum / Memorandum of Association	The memorandum of association of our Company, as amended from time to time
Nomination and Remuneration Committee	The nomination and remuneration committee of our Company, constituted on April 28, 2020 in accordance with Section 178 of the Companies Act, 2013, the details of which are provided in “Our Management” on page no. 101 of this Prospectus
Non-Executive Director	A Director not being an Executive Director or an Independent Director
Promoter(s) / Core Promoter	The Promoter of our Company, namely, Leena Kamat and Rajkumar Kamat
Promoter Group	Such persons, entities and companies constituting our promoter group pursuant to Regulation 2(1)(pp) of the SEBI (ICDR) Regulations as disclosed in the Chapter titled “Our Promoter and Promoter Group” on page no. 113 of this Prospectus
Registered Office	Registered Office of our Company situated at: C/O OM Ventures, Shed No D-2/12, Bicholim Industrial Estate, Bicholim, Goa - 403504
Registrar of Companies / RoC	Company Law Bhawan, EDC Complex, Plot No.21, Poatto Panaji, Goa - 403001
Restated Financial Statements	The financial information of the Company which comprises of the restated statement of assets and liabilities as at March 31, 2022, March 31, 2021 and March 31, 2020 and the restated statement of profit and loss and the restated cash flow statement for the years ended March 31, 2022 2021 and 2020 and the related notes, schedules and annexures thereto included in this Prospectus, which have been prepared in accordance with Section 133 of the Companies Act, 2013, and restated in accordance with the SEBI ICDR Regulations.
Stakeholders’ Relationship Committee	The stakeholder’s relationship committee of our Company, constituted on April 28, 2020 in accordance with Section 178 of the Companies Act, 2013, the details of which are provided in “Our Management” on page no.98 on this Prospectus.
Stock Exchange/ BSE SME	SME Platform of BSE Limited.
Willful Defaulter(s)	Willful defaulter as defined under Regulation 2(1)(III) of the SEBI ICDR Regulations

#### **Issue Related Term**

<b>Term</b>	<b>Description</b>
Acknowledgement Slip	The slip or document issued by the Designated Intermediary to an Applicant as proof of registration of the Application Form
Abridged Prospectus	Abridged prospectus means a memorandum containing such salient features of a prospectus as may be specified by SEBI in this behalf
Allot / Allotment / Allotted	Unless the context otherwise requires, the allotment of the Equity Shares pursuant to the Issue to the successful applicants, including transfer of the Equity Shares pursuant to the Issue to the successful applicants.
Allotment Advice	A note or advice or intimation of Allotment sent to the Applicants who have been or are to be Allotted the Equity Shares after the Basis of Allotment has been approved by the Designated Stock Exchange
Allottees	The successful applicant to whom the Equity Shares are being/have been allotted
Applicant / Investor	Any prospective investor who makes an application pursuant to the terms of the Prospectus



Term	Description
Application Amount	The amount at which the prospective investors shall apply for Equity Shares of our Company in terms of this Prospectus
Application Supported by Blocked Amount/ ASBA	An application, whether physical or electronic, used by ASBA Applicant to make an application authorizing an SCSB to block the Application Amount in the specified Bank Account maintained with such SCSB and will include applications made by RIIs using the UPI Mechanism, where the Application Amount shall be blocked upon acceptance of UPI Mandate Request by RIIs using UPI Mechanism
ASBA Account	A bank account maintained with an SCSB by an ASBA Applicants, as specified in the ASBA Form submitted by ASBA Applicants for blocking the Application Amount mentioned in the relevant ASBA Form and includes the account of an RIIs which is blocked upon acceptance of a UPI Mandate Request made by the RIIs using the UPI Mechanism.
ASBA Applicant(s)	Any prospective investors in the Issue who intend to submit the Application through the ASBA process
ASBA Application / Application	An application form, whether physical or electronic, used by ASBA Applicants which will be considered as the application for Allotment in terms of the Prospectus
ASBA Form	An application form (with and without the use of UPI, as may be applicable), whether physical or electronic, used by the ASBA Applicants and which will be considered as an application for Allotment in terms of the Prospectus
Banker(s) to the Company	Such banks which are disclosed as Bankers to our Company in the chapter titled “General Information” on page no. 41 of this Prospectus
Banker(s) to the Issue	The banks which are Clearing Members and registered with SEBI as Banker to an Issue with whom the Escrow Agreement is entered and in this case being Axis Bank.
Banker(s) to the Issue and Sponsor Bank Agreement	Agreement dated June 06, 2022, entered into between our Company, Lead Manager, the Registrar to the Issue, Banker to the Issue and Sponsor Bank for collection of the Application Amount on the terms and conditions thereof
Basis of Allotment	The basis on which the Equity Shares will be Allotted to successful Applicants under the Issue and which is described in the chapter titled “Issue Procedure” beginning on page no. 179 of this Prospectus
Broker Centres	Broker centres notified by the Stock Exchanges, where the Applicants can submit the Application Forms to a Registered Broker  The details of such broker centres, along with the names and contact details of the Registered Brokers, are available on the website of the BSE
CAN or Confirmation of Allocation Note	The note or advice or intimation sent to each successful Applicant indicating the Equity Shares which will be Allotted, after approval of Basis of Allotment by the Designated Stock Exchange
Client ID	Client identification number maintained with one of the Depositories in relation to demat account
Controlling Branches	Such branches of the SCSBs which coordinate with the Lead Manager, the Registrar to the Issue and the Stock Exchange and a list of which is available at <a href="http://www.sebi.gov.in">www.sebi.gov.in</a> or at such other website as may be prescribed by SEBI from time to time
Collection Centers	Centers at which the Designated intermediaries shall accept the Application Forms, being the Designated SCSB Branch for SCSBs, specified locations for syndicate, broker center for registered brokers, designated RTA Locations for RTAs and designated CDP locations for CDPs
Collecting Depository Participant” or “CDP	A depository participant as defined under the Depositories Act, 1996, registered with SEBI and who is eligible to procure Applications at the Designated CDP Locations in terms of circular No. GR/CFD/POLICYCELL/11/2015 dated November 10, 2015 issued by SEBI and the UPI Circulars issued by SEBI as per the list available on the websites of Stock Exchange.
Demographic Details	Details of the Applicants including the Applicants’ address, name of the Applicants’ father/husband, investor status, occupation and bank account details and UPI ID wherever applicable
Depository/ Depositories	A depository registered with SEBI under the SEBI (Depositories and Participant) Regulations, 1996 as amended from time to time, being NSDL and CDSL
Depository Participant / DP	A depository participant as defined under the Depositories Act, 1996

Term	Description
Designated Locations CDP	Such locations of the CDPs where Applicants can submit the ASBA Forms and in case of RIIs only ASBA Forms with UPI.  The details of such Designated CDP Locations, along with names and contact details of the Collecting Depository Participants eligible to accept ASBA Forms are available on the website of the Stock Exchange.
Designated Date	The date on which relevant amounts are transferred from the ASBA Accounts to the Public Issue Account or the Refund Account, as the case may be, and the instructions are issued to the SCSBs (in case of RIIs using UPI Mechanism, instruction issued through the Sponsor Bank) for the transfer of amounts blocked by the SCSBs in the ASBA Accounts to the Public Issue Account or the Refund Account, as the case may be, in terms of the Prospectus following which Equity Shares will be Allotted in the Issue
Designated Intermediaries / Collecting Agent	In relation to ASBA Forms submitted by RIIs authorising an SCSB to block the Application Amount in the ASBA Account, Designated Intermediaries shall mean SCSBs  In relation to ASBA Forms submitted by RIIs where the Application Amount will be blocked upon acceptance of UPI Mandate Request by such RII using the UPI Mechanism, Designated Intermediaries shall mean syndicate members, sub-syndicate members, Registered Brokers, CDPs and RTAs  In relation to ASBA Forms submitted by QIBs and NIBs, Designated Intermediaries shall mean SCSBs, syndicate members, sub-syndicate members, Registered Brokers, CDPs and RTAs
Designated Market Maker	Aryaman Capital Markets Limited will act as the Market Maker and has agreed to receive or deliver the specified securities in the market making process for a period of three years from the date of listing of our Equity Shares or for a period as may be notified by amendment to SEBI ICDR Regulations
Designated Locations RTA	Such locations of the RTAs where Applicants can submit the ASBA Forms to RTAs and in case of RIIs only ASBA Forms with UPI. The details of such Designated RTA Locations, along with names and contact details of the RTAs eligible to accept ASBA Forms are available on the website of the Stock Exchange
Designated Branches SCSB	Such branches of the SCSBs which shall collect the ASBA Forms (other than ASBA Forms submitted by RIIs where the Application Amount will be blocked upon acceptance of UPI Mandate Request by such RII using the UPI Mechanism), a list of which is available on the website of SEBI at <a href="http://www.sebi.gov.in/sebiweb/other/OtherAction.do?doRecognised=yes">www.sebi.gov.in/sebiweb/other/OtherAction.do?doRecognised=yes</a>  Intermediaries or at such other website as may be prescribed by SEBI from time to time
Designated Stock Exchange	BSE Limited (“BSE”)
Draft Prospectus	This Draft Prospectus dated February 01, 2022 issued in accordance with the SEBI (ICDR) Regulations.
Eligible NRI(s)	An NRI(s) from jurisdictions outside India where it is not unlawful to make an Issue or invitation under the Issue and in relation to whom the ASBA Form and the Prospectus will constitute an invitation to subscribe to or to purchase the Equity Shares of the Issuer.
First/ Sole Applicant	The Applicant whose name appears first in the Application Form or the Revision Form and in case of joint Applicants, whose name appears as the first holder of the beneficiary account held in joint names
FII / Foreign Institutional Investors	Foreign Institutional Investor (as defined under SEBI (Foreign Institutional Investors) Regulations, 1995, as amended) registered to with SEBI under applicable laws in India.
Foreign Portfolio Investor / FPIs	Foreign Portfolio Investor as defined under the Securities and Exchange Board of India (Foreign Portfolio Investors) Regulations, 2019
Fugitive Economic Offender	An individual who is declared a fugitive economic offender under Section 12 of the Fugitive Economic Offenders Act, 2018
General Information Document or GID	The General Information Document for investing in public issues prepared and issued in accordance with the circular circular (SEBI/HO/CFD/DIL1/CIR/P/2020/37) dated March 17, 2020 notified by SEBI and the circular no. (SEBI/HO/CFD/DIL2/CIR/P/2020/50) dated March 30, 2020 issued by SEBI. The General Information Document is available on the websites of the Stock Exchanges and the Lead Manager

Term	Description
Issue	The initial public Issue of 5,04,000 Equity Shares of face value of ₹ 10 each for cash at a price of ₹ 126 each, aggregating to ₹ 635.04 lakhs.
Issue Agreement	The Memorandum of Understanding (MoU) dated January 21, 2022 and addendum dated June 02, 2022 entered amongst our Company and the Lead Manager, pursuant to which certain arrangements are agreed to in relation to the Issue
Issue Closing Date	The date on which the Issue closes for subscription being September 05, 2022
Issue Opening Date	The date on which the Issue opens for subscription being August 29, 2022
Issue Period	The period between the Issue Opening Date and the Issue Closing Date inclusive of both days and during which prospective Applicants can submit their Applications
Issue Price	The Price at which the Equity Shares are being Issued by our Company in consultation with the Lead Manager under this Prospectus being ₹ 126 per equity share
Issue Proceeds	Proceeds to be raised by our Company through this Issue, for further details please refer chapter titled “Objects of the Issue” page no. 56 of this Prospectus
Issue Size	The Public Issue 5,04,000 of Equity shares of ₹10 each at price of ₹ 126 per Equity share, aggregating to ₹ 635.04 lakhs by our Company.
Lead Manager / LM	Lead Manager to the Issue, being Aryaman Financial Services Limited.
Listing Agreement	Unless the context specifies otherwise, this means the Equity Listing Agreement to be signed between our Company and BSE Limited
Lot Size	The Market lot and Trading lot for the Equity Share is 1,000 and in multiples of 1,000 thereafter; subject to a minimum allotment of 1,000 share to the successful applicants
Market Making Agreement	The Market Making Agreement dated March 09, 2022 and addendum dated June 02, 2022 between our Company, Lead Manager and Market Maker
Market Maker Reservation Portion	The reserved portion 28,000 Equity Shares of face value of ₹ 10 each fully paid for cash at a price of ₹ 126 per Equity Share aggregating to ₹ 35.28 lakhs for the Market Maker in this Issue.
Minimum Promoter’s Contribution	Aggregate of 20% of the fully diluted post-Issue Equity Share capital of our Company held by our Promoter which shall be provided towards minimum promoter of 20% and locked-in for a period of three years from the date of Allotment
Mobile App(s)	The mobile applications listed on the website of SEBI at <a href="https://www.sebi.gov.in/sebiweb/other/OtherAction.do?doRecognisedFpi=yes&amp;intmId=40">https://www.sebi.gov.in/sebiweb/other/OtherAction.do?doRecognisedFpi=yes&amp;intmId=40</a> or such other website as may be updated from time to time, which may be used by RIIs to submit Applications using the UPI Mechanism
Mutual Funds	Mutual funds registered with SEBI under the Securities and Exchange Board of India (Mutual Funds) Regulations, 1996
Net Issue	The Net Issue of 4,76,000 Equity Shares of ₹ 10 each at price of ₹ 126 per Equity Shares aggregating to ₹ 599.76 lakhs by our Company.
Net Proceeds	The Gross Proceeds less our Company’s share of the Issue expenses. For further details regarding the use of the Net Proceeds and the Issue expenses, see “Objects of the Issue” beginning on page no. 56 of this Prospectus
Non - Institutional Investors	All Applicants that are not QIBs or Retail Individual Applicants and who have applied for Equity Shares for an amount of more than ₹ 2,00,000 (but not including NRIs other than Eligible NRIs)
Non-Resident or NR	A person resident outside India, as defined under FEMA and includes Eligible non-resident Indian, Eligible QFIs, FIIs registered with SEBI, FVCIs and FPIs
OCB / Overseas Corporate Body	Overseas Corporate Body means and includes an entity defined in clause (xi) of Regulation 2 of the Foreign Exchange Management (Withdrawal of General Permission to Overseas Corporate Bodies (OCB’s) Regulations 2003 and which was in existence on the date of the commencement of these Regulations and immediately prior to such commencement was eligible to undertake transactions pursuant to the general permission granted under the Regulations. OCBs are not allowed to invest in this Issue.
Prospectus	The Prospectus dated August 23, 2022, to be filed with the RoC containing, inter alia, the Issue opening and Closing date and other information.
Public Issue Account	A bank account to be opened under section 40(3) of the Companies Act, 2013 to receive monies from the ASBA Accounts on the Designated Date
Qualified Institutional Buyers or QIBs	A qualified institutional buyer as defined under Regulation 2(1)(ss) of the SEBI ICDR Regulations
Refund Account	The account to be opened with the Refund Bank, from which refunds, if any, of the whole or part of the Application Amount to the Applicants shall be made



Term	Description
Refund Bank(s)	The Bank which is a clearing member and registered with SEBI as a Banker to an Issue and with whom the Refund Account will be opened, in this case being Axis Bank.
Registered Brokers	Stock brokers registered with SEBI under the Securities and Exchange Board of India (Stock Brokers and Sub Brokers) Regulations, 1992 and the stock exchanges having nationwide terminals, other than the Members of the Syndicate eligible to procure Bids in terms of Circular No. CIR/CFD/14/2012 dated October 04, 2012 issued by SEBI.
Registrar Agreement	The agreement dated January 27, 2022 entered amongst our Company and the Registrar to the Issue, in relation to the responsibilities and obligations of the Registrar to the Issue pertaining to this Issue
Registrar and Share Transfer Agents / RTAs	Registrar and Share Transfer Agents registered with SEBI and eligible to procure Applications at the Designated RTA Locations in terms of circular no. CIR/CFD/POLICYCELL/11/2015 dated November 10, 2015 issued by SEBI
Registrar to the Issue / Registrar	The Registrar to the Issue being Bigshare Services Private Limited
Retail Individual Investor(s) / RII(s)	Individual Applicants or minors applying through their natural guardians, (including HUFs in the name of Karta and Eligible NRIs) who have applied for an amount less than or equal to ₹ 2.00 lakhs in this Issue
Revision Form	The form used by the Applicants to modify the quantity of the Equity Shares or the Application Amount in any of their ASBA Form(s) or any previous Revision Form(s) QIBs and Non-Institutional Investors are not allowed to withdraw or lower their Application Amounts (in terms of quantity of Equity Shares or the Application Amount) at any stage. Retail Individual Applicants can withdraw or revise their Application until Issue Closing Date
Self - Certified Syndicate Bank(s) or "SCSB(s)	Banks registered with SEBI, offering services in relation to ASBA, where the Bid Amount will be blocked by authorising an SCSB, a list of which is available on the website of SEBI at <a href="https://www.sebi.gov.in/sebiweb/other/OtherAction.do?doRecognised=yes">https://www.sebi.gov.in/sebiweb/other/OtherAction.do?doRecognised=yes</a> or such other website as updated from time to time, and in in relation to RIBs using the UPI Mechanism, a list of which is available on the website of SEBI at <a href="https://sebi.gov.in/sebiweb/other/OtherAction.do?doRecognisedFpi=yes&amp;intmId=40">https://sebi.gov.in/sebiweb/other/OtherAction.do?doRecognisedFpi=yes&amp;intmId=40</a> or such other website as updated from time to time
Specified Locations	Centres where the Syndicate shall accept ASBA Forms from Applicants and in case of RIIs only ASBA Forms with UPI
Sponsor Bank	A Banker to the Issue which is registered with SEBI and is eligible to act as a Sponsor Bank in a public issue in terms of applicable SEBI requirements and has been appointed by the Company in consultation with the LM to act as a conduit between the Stock Exchanges and NPCI to push the UPI Mandate Request in respect of RIIs as per the UPI Mechanism, in this case being Axis Bank.
Systemically Important Non-Banking Financial Company	Systemically important non-banking financial company as defined under Regulation 2(1)(iii) of the SEBI ICDR Regulations
TRS / Transaction Registration Slip	The slip or document issued by a member of the Syndicate or an SCSB (only on demand), as the case may be, to the Applicant, as proof of registration of the Application.
Underwriters	The underwriters in this case are Aryaman Financial Services Limited and Aryaman Capital Markets Limited.
Underwriting Agreement	The agreement dated March 09, 2022 and addendum dated June 02, 2022 entered amongst our Company and the Underwriters
UPI ID	ID created on UPI for single-window mobile payment system developed by the National Payments Corporation of India (NPCI)
UPI Mandate Request	A request (intimating the RII by way of a notification on the UPI application and by way of a SMS directing the RII to such UPI application) to the RII initiated by the Sponsor Bank to authorise blocking of funds on the UPI application equivalent to Application Amount and subsequent debit of funds in case of Allotment

Term	Description
UPI mechanism/ UPI Circulars	The SEBI circular no. SEBI/HO/CFD/DIL2/CIR/P/2018/138 dated November 1, 2018, SEBI circular no. SEBI/HO/CFD/DIL2/CIR/P/2019/50 dated April 3, 2019, SEBI circular no. SEBI/HO/CFD/DIL2/CIR/P/2019/76 dated June 28, 2019, SEBI circular no. SEBI/HO/CFD/DIL2/CIR/P/2019/85 dated July 26, 2019, circular no. SEBI/HO/CFD/DCR2/CIR/P/2019/133 dated November 8, 2019 circular no. SEBI/HO/CFD/DIL2/CIR/P/2020/50 dated March 30, 2020, SEBI circular no. SEBI/HO/CFD/DIL2/CIR/P/2021/2480/1/M dated March 16, 2021, SEBI circular no. SEBI/HO/CFD/DIL1/CIR/P/2021/47 dated March 31, 2021, SEBI Circular no. SEBI/HO/CFD/DIL2/P/CIR/2021/570 dated June 2, 2021 and any subsequent circulars or notifications issued by SEBI in this regard.
UPI PIN	Password to authenticate UPI transaction
Working Day	The days on which commercial banks in Delhi are open for business; provided however, with reference to (i) announcement of Price Band; and (ii) Issue Period, "Working Day" shall mean all days, excluding all Sundays, Saturdays and public holidays, on which commercial banks in Delhi are open for business; (iii) the time period between the Issue Closing Date and the listing of the Equity Shares on the Stock Exchanges, "Working Day" shall mean all trading days of Stock Exchanges, excluding Sundays and bank holidays, as per the circulars issued by SEBI
U.S. Securities Act	U.S. Securities Act of 1933, as amended.

#### Technical / Industry related terms

Term	Description
ASP	Activated Sludge Process
BNI	Business Network International
BNR	Biological Nutrient Removal
BoP	Bottom of Pyramid
CO <sub>2</sub>	Carbon dioxide
DRDO	Defence Research and Development Organisation
EPS	Expanded Polystyrene
ETP	Effluent Treatment Plant
FRP	Fibre Reinforced Plastic
GDP	Gross Domestic Product
GRP	Glass Reinforced Polymers
GST	Goods and Services Tax
ISO	International Organization for Standardization
SBM	Swachh Bharat Mission
NGO	Non Governmental Organizations
MED	Multi-effect distillation
MED-VC	Multi-effect distillation-vapor compression
MLSS	Mixed liquor suspended solids
ODF	Open-Defecation Free
PCB	Pollution Control Board
PSU	Public Sector Undertakings
QMS	Quality Management System
STP	Sewage Treatment Plants
TIFAC	Technology investigations & Forecasting
VC	Vapor compression
WASH	Water, Sanitation And Hygiene
WWT	Water And Wastewater Treatment

#### Conventional Terms / General Terms / Abbreviations

Term	Description
A/c	Account
ACS	Associate Company Secretary
AGM	Annual General Meeting

Term	Description
AIF	Alternative Investment Fund as defined in and registered with SEBI under the Securities and Exchange Board of India (Alternative Investments Funds) Regulations, 2012
AS / Accounting Standards	Accounting Standards as issued by the Institute of Chartered Accountants of India
ASBA	Applications Supported by Blocked Amount
AY	Assessment Year
Banking Regulation Act	Banking Regulation Act, 1949
BSE	BSE Limited
CAGR	Compound Annual Growth Rate
Category I foreign portfolio investor(s) / Category I FPIs	FPIs who are registered as “Category I foreign portfolio investors” under the SEBI FPI Regulations
Category II foreign portfolio investor(s) / Category II FPIs	FPIs who are registered as “Category II foreign portfolio investors” under the SEBI FPI Regulations
Category III foreign portfolio investor(s) / Category III FPIs	FPIs who are registered as “Category III foreign portfolio investors” under the SEBI FPI Regulations
CDSL	Central Depository Services (India) Limited
CFO	Chief Financial Officer
CFPI	Consumer Food Price Index
CGST	Central GST
CIBIL	Credit Information Bureau (India) Limited
CIN	Company Identification Number
CIT	Commissioner of Income Tax
Client ID	Client identification number of the Applicant’s beneficiary account
Companies Act	Unless specified otherwise, this would imply to the provisions of the Companies Act, 2013 (to the extent notified) and /or Provisions of Companies Act, 1956 w.r.t. the sections which have not yet been replaced by the Companies Act, 2013 through any official notification.
Companies Act, 2013	The Companies Act, 2013 published on August 29, 2013 and applicable to the extent notified by MCA till date.
COVID - 19	A public health emergency of international concern as declared by the World Health Organization on January 30, 2020 and a pandemic on March 11, 2020
CPI	Consumer Price Index
CSR	Corporate Social Responsibility
CST	Central Sales Tax
CY	Calendar Year
Depositories	Together, NSDL and CDSL
Depositories Act	Depositories Act, 1996
DIN	Director Identification Number
DIPP	Department of Industrial Policy and Promotion, Ministry of Commerce and Industry, Government of India
DP	Depository Participant, as defined under the Depositories Act 1996
DPIIT	Department for Promotion of Industry and Internal Trade, Ministry of Commerce and Industry, Government of India earlier known as Department of Industrial Policy and Promotion, Ministry of Commerce and Industry, Government of India
DP ID	Depository Participant’s identification
EBITDA	Earnings before Interest, Taxes, Depreciation and Amortization
ECS	Electronic Clearing System
EGM/ EoGM	Extraordinary General Meeting
EMDEs	Emerging Markets and Developing Economies
EPS	Earnings Per Share
FCNR Account	Foreign Currency Non Resident Account
FDI	Foreign Direct Investment
FEMA	Foreign Exchange Management Act, 1999, read with rules and regulations thereunder
FEMA Regulations	Foreign Exchange Management (Non-Debt Instruments) Rules, 2019
FIIIs	Foreign Institutional Investors (as defined under Foreign Exchange Management (Transfer

Term	Description
	or Issue of Security by a Person Resident outside India) Regulations, 2000) registered with SEBI under applicable laws in India
FIPB	Foreign Investment Promotion Board
FPIs	Foreign Portfolio Investors as defined under the SEBI FPI Regulations
FTP	Foreign Trade Policy
FVCI	Foreign Venture Capital Investors as defined and registered under the SEBI FVCI Regulations
FY / Fiscal / Financial Year	Period of twelve months ended March 31 of that particular year, unless otherwise stated
GDP	Gross Domestic Product
GoI/Government	Government of India
GST	Goods & Services Tax
GW	Gigawatt
HNIs	High Networth Individuals
HUF	Hindu Undivided Family
I.T. Act	Income Tax Act, 1961, as amended from time to time
ICAI	The Institute of Chartered Accountants of India
ICSI	Institute of Company Secretaries of India
IFRS	International Financial Reporting Standards
IGST	Integrated Goods and Services Tax Act, 2017
IIP	Index of Industrial Production
IMF	International Monetary Fund
Indian GAAP	Generally Accepted Accounting Principles in India
IPO	Initial Public Offering
IRDAI Investment Regulations	Insurance Regulatory and Development Authority (Investment) Regulations, 2016
ISIN	International Securities Identification Number
ISO	International Organization for Standardization
IST	Indian Standard Time
JV	Joint Venture
KM / Km / km	Kilo Meter
MCA	Ministry of Corporate Affairs, Government of India
Merchant Banker	Merchant Banker as defined under the Securities and Exchange Board of India (Merchant Bankers) Regulations, 1992
MEIS	Merchandise Exports from India Scheme
MMR	Maternal Mortality Ratio
MoF	Ministry of Finance, Government of India
MOU	Memorandum of Understanding
NA / N. A.	Not Applicable
NACH	National Automated Clearing House
NAV	Net Asset Value
NBFC	Non Banking Financial Company
NCLT	National Company Law Tribunal
NECS	National Electronic Clearing Service
NEFT	National Electronic Fund Transfer
NEIL	National Engineering Industries Ltd
NIAIMT	National Institute for Automotive Inspection, Maintenance & Training
NOC	No Objection Certificate
NPCI	National Payments Corporation of India
NRE Account	Non Resident External Account
NRO Account	Non Resident Ordinary Account
NSDL	National Securities Depository Limited
NSE	National Stock Exchange of India Limited
BSE	BSE Limited
p.a.	Per annum
PE	private equity
P/E Ratio	Price/Earnings Ratio

Term	Description
PAC	Persons Acting in Concert
PAN	Permanent Account Number
PAT	Profit After Tax
PLR	Prime Lending Rate
PMI	Purchasing Managers' Index
PPP	Purchasing power parity
R&D	Research and development
RBI	Reserve Bank of India
Regulation S	Regulation S under the U.S. Securities Act
RoC	Registrar of Companies
ROE	Return on Equity
RONW	Return on Net Worth
Rupees / Rs. / ₹	Rupees, the official currency of the Republic of India
RTGS	Real Time Gross Settlement
SCRA	Securities Contract (Regulation) Act, 1956, as amended from time to time
SCRR	Securities Contracts (Regulation) Rules, 1957, as amended from time to time
SEBI	Securities and Exchange Board of India
SEBI Act	Securities and Exchange Board of India Act, 1992
SEBI AIF Regulations	Securities and Exchange Board of India (Alternative Investments Funds) Regulations, 2012, as amended
SEBI FII Regulations	Securities and Exchange Board of India (Foreign Institutional Investors) Regulations, 1995
SEBI FPI Regulations	Securities and Exchange Board of India (Foreign Portfolio Investors) Regulations, 2019, as amended
SEBI FVCI Regulations	Securities and Exchange Board of India (Foreign Venture Capital Investor) Regulations, 2000, as amended
SEBI ICDR Regulations	Securities and Exchange Board of India (Issue of Capital and Disclosure Requirements) Regulations, 2018, as amended
SEBI LODR Regulations, 2015 / SEBI Listing Regulations	Securities and Exchange Board of India (Listing Obligations and Disclosure Requirements) Regulations, 2015 notified on September 2, 2015
SEBI SAST Regulations	Securities and Exchange Board of India (Substantial Acquisition of Shares and Takeovers) Regulations, 2011, as amended
SEBI VCF Regulations	Securities and Exchange Board of India (Venture Capital Fund) Regulations, 1996, as repealed by the SEBI AIF Regulations, as amended
SEIS	Service Exports from India Scheme
Sec.	Section
Securities Act	U.S. Securities Act of 1933, as amended
SGST	State Goods and Services Tax Act, 2017
SICA	Sick Industrial Companies (Special Provisions) Act, 1985
STT	Securities Transaction Tax
Takeover Regulations	Securities and Exchange Board of India (Substantial Acquisition of Shares and Takeovers) Regulations, 2011
TIN	Taxpayers Identification Number
TDS	Tax Deducted at Source
UGST	Union Territory Goods and Services Tax Act, 2017
UPI	Unified Payments Interface, a payment mechanism that allows instant transfer of money between any two persons bank account using a payment address which uniquely identifies a person's bank account.
US/United States	United States of America
USD/ US\$/ \$	United States Dollar, the official currency of the Unites States of America
VAT	Value Added Tax
VCF / Venture Capital Fund	Foreign Venture Capital Funds (as defined under the Securities and Exchange Board of India (Venture Capital Funds) Regulations, 1996) registered with SEBI under applicable laws in India.
WEO	World Economic Outlook
Wilful Defaulter or a fraudulent borrower (s)	Wilful defaulter or a fraudulent borrower as defined under Regulation 2(1)(III) of the SEBI ICDR Regulations



Term	Description
WIP	Work in process
WPI	Wholesale Price Index

## CERTAIN CONVENTIONS; PRESENTATION OF FINANCIAL INDUSTRY AND MARKET DATA

### Certain Conventions

All references to “India” contained in this Prospectus are to the Republic of India. In this Prospectus, our Company has presented numerical information in “lakhs” units. One represents 1, 00,000.

### Financial Data

Unless stated otherwise, the financial information in this Prospectus is derived from our Restated Financial Statements. Certain additional financial information pertaining to our Group Companies is derived from its financial statements. The Restated Financial Statements included in this Prospectus are for the period ended March 31, 2022, 2021 and 2020 have been prepared in accordance with Indian GAAP and the Companies Act, and have been restated in accordance with the SEBI (ICDR) Regulations. For further information, see please refer “*Financial Information*” beginning on page no. 121 of this Prospectus.

In this Prospectus, any discrepancies in any table between the total and the sums of the amounts listed are due to rounding off. All figures in decimals have been rounded off to the second decimal and all percentage figures have been rounded off to two decimal places.

Our Company’s financial year commences on April 1 and ends on March 31 of the next year. Accordingly, all references to a particular financial year, unless stated otherwise, are to the 12 month period ended on March 31 of that year. Unless stated otherwise, or the context requires otherwise, all references to a “year” in this Prospectus are to a calendar year.

There are significant differences between Indian GAAP, IFRS and US GAAP. The Company has not attempted to quantify their impact on the financial data included herein and urges you to consult your own advisors regarding such differences and their impact on the Company’s financial data. Accordingly to what extent, the financial statements included in this Prospectus will provide meaningful information is entirely dependent on the reader’s level of familiarity with Indian accounting practices / Indian GAAP. Any reliance by persons not familiar with Indian Accounting Practices on the financial disclosures presented in this Prospectus should accordingly be limited.

Unless the context otherwise indicates, any percentage amounts, as set forth in “*Risk Factors*”, “*Our Business*” and “*Management’s Discussion and Analysis of Financial Conditions and Results of Operations*” on page nos. 19, 72 and 141 respectively, of this Prospectus, and elsewhere in this Prospectus have been calculated on the basis of the Restated Financial Statements of our Company.

### Currency and Units of Presentation

All references to “Rupees”, “Rs.” or “₹” are to Indian Rupees, the official currency of the Republic of India. All references to “US\$” or “US Dollars” or “USD” are to United States Dollars, the official currency of the United States of America.

This Prospectus may contain conversions of certain US Dollar and other currency amounts into Indian Rupees that have been presented solely to comply with the requirements of the SEBI Regulations. These conversions should not be construed as a representation that those US Dollar or other currency amounts could have been, or can be converted into Indian Rupees, at any particular rate.

### Definitions

For definitions, please refer the Chapter titled “*Definitions and Abbreviations*” on page no.1 of this Prospectus. In the Section titled “*Main Provisions of the Articles of Association of Our Company*” beginning on page no. 199 of this Prospectus, defined terms have the meaning given to such terms in the Articles of Association.

### Industry and Market Data

Unless stated otherwise, the industry and market data and forecasts used throughout this Prospectus has been obtained from industry sources as well as Government Publications. Industry sources as well as Government Publications generally state that the information contained in those publications has been obtained from sources believed to be

reliable but that their accuracy and completeness and underlying assumptions are not guaranteed and their reliability cannot be assured.

Further, the extent to which the industry and market data presented in this Prospectus is meaningful depends on the reader's familiarity with and understanding of the methodologies used in compiling such data. There are standard data gathering methodologies in the industry in which we conduct our business, and methodologies and assumptions may vary widely among different industry sources.

## FORWARD-LOOKING STATEMENTS

All statements contained in this Prospectus that are not statements of historical fact constitute forward-looking statements. All statements regarding our expected financial condition and results of operations, business, plans and prospects are forward-looking statements. These forward-looking statements include statements with respect to our business strategy, our revenue and profitability, our projects and other matters discussed in this Prospectus regarding matters that are not historical facts. Investors can generally identify forward-looking statements by the use of terminology such as “aim”, “anticipate”, “believe”, “expect”, “estimate”, “intend”, “objective”, “plan”, “project”, “may”, “will”, “will continue”, “will pursue”, “contemplate”, “future”, “goal”, “propose”, “will likely result”, “will seek to” or other words or phrases of similar import. All forward looking statements (whether made by us or any third party) are predictions and are subject to risks, uncertainties and assumptions about us that could cause actual results to differ materially from those contemplated by the relevant forward-looking statement.

Forward-looking statements reflect our current views with respect to future events and are not a guarantee of future performance. These statements are based on our management’s beliefs and assumptions, which in turn are based on currently available information. Although we believe the assumptions upon which these forward-looking statements are based are reasonable, any of these assumptions could prove to be inaccurate, and the forward-looking statements based on these assumptions could be incorrect.

Further the actual results may differ materially from those suggested by the forward-looking statements due to risks or uncertainties associated with our expectations with respect to, but not limited to, regulatory changes pertaining to the industries in India in which our Company operates and our ability to respond to them, our ability to successfully implement our strategy, our growth and expansion, technological changes, our exposure to market risks, general economic and political conditions in India and overseas which have an impact on our business activities or investments, the monetary and fiscal policies of India and other jurisdictions in which we operate, inflation, deflation, unanticipated volatility in interest rates, foreign exchange rates, equity prices or other rates or prices, the performance of the financial markets in India and globally, changes in domestic laws, regulations and taxes, changes in competition in our industry and incidence of any natural calamities and/or acts of violence. Other important factors that could cause actual results to differ materially from our expectations include, but are not limited to, the following:

- Changes in laws and regulations relating to the sectors/areas in which we operate;
- Inability to identify the new premises may adversely affect the operations, finances and profitability of the Company;
- Increased competition in Sanitation Infrastructure and Waste Management Industries.
- General economic and business conditions in the markets in which we operate and in the local, regional, national and international economies;
- Inflation, deflation, unanticipated turbulence in interest rates, equity prices or other rates or prices;
- Our inability to maintain or enhance our brand recognition;
- Inability to adequately protect our Intellectual Property Rights
- Changes in consumer demand
- Inability to identify or effectively respond to customer needs, expectations or trends in a timely manner;
- Our ability to successfully implement our growth strategy and expansion plans, and to successfully launch and implement various projects;
- Volatility of loan interest rates and inflation;
- Our failure to keep pace with rapid changes in technology;
- Our ability to meet our further capital expenditure requirements;
- Fluctuations in operating costs;
- Our ability to attract and retain qualified personnel;
- Conflict of Interest with affiliated companies, the promoter group and other related parties;
- Changes in political and social conditions in India, the monetary and interest rate policies of India and other countries;
- General economic and business conditions in the markets in which we operate and in the local, regional, national and international economies;
- Changes in government policies and regulatory actions that apply to or affect our business; and
- The occurrence of natural disasters or calamities;

For further discussions of factors that could cause our actual results to differ, please refer the section titled “*Risk Factors*”, “*Our Business*” and “*Management’s Discussion and Analysis of Financial Condition and Results of Operations*” beginning on page nos. 19, 72 and 141 of this Prospectus respectively.

Neither our Company, our Directors, our Promoter, the Lead Manager nor any of their respective affiliates have any obligation to update or otherwise revise any statements reflecting circumstances arising after the date hereof or to reflect the occurrence of underlying events, even if the underlying assumptions do not come to fruition. In accordance with SEBI requirements, our Company will ensure that investors in India are informed of material developments from the date of this Prospectus until the time of the grant of listing and trading permission by the Stock Exchanges.



## SECTION II – SUMMARY OF OFFER DOCUMENT

### A. Summary of Business

Our Company is involved in manufacturing and supplying of a vast portfolio of products and services for a cleaner and greener planet which includes Fibre Glass doors and allied products, Bio Digester Toilets with one of its kind DRDO technology and actively contributing to wastewater recycling through its solution in Sewage Treatment Plants (STP) and Effluent Treatment Plants (ETP). The company has taken over the running business of our promoter M/s 'Om Ventures', a sole proprietorship through a business transfer agreement dated August 31, 2021. The company has supplied more than 2,00,000 FRP doors thereby saving more than thousands of trees and 2500 Bio Toilets to household helping reduction to open defecation thereby contributing to clean and green surroundings. We have become leaders for FRP Doors in Goa, North Karnataka and Kokan. We are presently recycling 1 Million litres of waste everyday for leading Hotels, Industries and Housing Company. For further details, please see "Our Business" on page no. 72 of this Prospectus.

### Summary of Industry

We operate in Sanitation Infrastructure and Waste Management Industries. For more details, please refer chapter titled "Industry Overview" beginning on page 66 of this Prospectus

### B. Our Promoters

Our Company is promoted by Rajkumar Kamat and Leena Kamat.

### C. Size of Issue

Issue	5,04,000 Equity Shares of ₹ 10 each for cash at a price of ₹ 126 per share, aggregating to ₹ 635.04 lakhs
<b>of Which:</b>	
Market Maker Reservation	28,000 Equity Shares of ₹ 10 each for cash at a price of ₹ 126 per share, aggregating to ₹ 35.28 lakhs
Net Issue	4,76,000 Equity Shares of ₹ 10 each for cash at a price of ₹ 126 per share, aggregating to ₹ 599.76 lakhs

### D. Object of the Issue

The fund requirements for each of the Object of the Issue are stated as below:

(₹ in lakhs)

Sr. No.	Object	Amount to be funded from Net Proceeds	Amount to be deployed from Net Proceeds in Fiscal 2023
1.	Long term lease deposit for manufacturing facilities	200.00	200.00
2.	Part Repayment of loan	80.00	80.00
3.	Funding Working Capital Requirement	151.18	151.18
4.	General Corporate Purpose	148.86	148.86
	<b>Total</b>	<b>580.04</b>	<b>580.04</b>

### E. Pre-Issue Shareholding of our Promoters, Promoter Group as a percentage of the paid-up share capital of the Company

Set forth is the Pre Issue shareholding of our Promoters, Promoter Group as a percentage of the paid-up share capital of the Company

Category of Promoters	Pre Issue	
	No. of Shares	% of Pre-Issue Paid Up Capital
<b>1. Promoter</b>		
Leena Kamat	10,91,848	92.73%
Rajkumar Kamat	63,152	5.36%

Category of Promoters	Pre Issue	
	No. of Shares	% of Pre-Issue Paid Up Capital
<b>Total</b>	<b>11,55,000</b>	<b>98.09%</b>
<b>2. Promoter Group (as defined by SEBI (ICDR) Regulations)</b>		
Nimisha Kamat	5,208	0.44%
Ashma Kamat	5,208	0.44%
<b>Total</b>	<b>10,416</b>	<b>0.88%</b>
<b>Total Promoters &amp; Promoter Group Holding</b>	<b>11,65,416</b>	<b>98.67%</b>
<b>Total Paid-up capital</b>	<b>11,77,500</b>	<b>100.00%</b>

#### F. Summary of Restated Financial Statement

(₹ in lakhs)

Particulars	For the year ended March 31,		
	2022	2021	2020
Share Capital	117.75	5.00	5.00
Net Worth	199.84	38.65	2.85
Total Income	807.55	295.23	56.83
Profit after Tax	80.94	35.50	3.15
Basic & Diluted EPS	9.48	6.97	0.61
Net Asset Value Per Share (₹)-based on actual no. of equity shares at the end of the year	16.97	77.31	5.70
Total Borrowings	217.52	0.00	0.25

#### G. There are no Auditor's Qualifications in any of the Financial Statements of the Company.

#### H. Summary of Outstanding Litigation are as follows

There is no material Litigation Outstanding as on the date of this Prospectus. For the details of litigation Proceedings, please refer the chapter titled "Outstanding Litigations and Material Developments" on page no. 152 of this Prospectus.

#### I. Risk Factors

Investors should read chapter titled "Risk Factors" beginning on page no. 19 of this Prospectus to get a more informed view before making any investment decisions.

#### J. Summary of contingent liabilities

There are no material contingent liabilities as of March 31, 2022.

For further information, please refer "Annexure XXVII Contingent Liability" in the chapter titled "Financial Statements as Restated" beginning from page no. 121 of this Prospectus

#### K. Summary of Related Party Transactions

Our Company has entered into certain transactions with our related parties including our Promoters, Promoter Group, Directors and their relatives as mentioned below:

(₹ in lakhs)

Particulars	As at March 31,		
	2022	2021	2020
<b>1) Finance</b>			
<b>Loans Taken</b>			
Opening Balance	-	0.25	-
Loan taken during the year	136.85	1.51	0.25
Interest	-	-	-
Loan repaid during the year	5.65	1.76	-
<b>Outstanding at the end of the year</b>	<b>131.20</b>	<b>0.00</b>	<b>0.25</b>

Particulars	As at March 31,		
	2022	2021	2020
<b>2) Expense</b>			
Remuneration	15.59	5.73	-
Assets & Liabilities taken Over ( Net)	151.21	-	-
<b>3) Money Received towards Share Capital</b>			
Equity Share Capital	80.25	-	4.70
<b>4) Outstanding</b>			
Payable	-	-	-

L. There are no financing arrangements whereby the Promoter Group, the Directors of our Company who are the Promoters of our Company, the Directors of our Company and their relatives have financed the purchase by any other person of securities of our Company during the period of 6 (six) months immediately preceding the date of this Prospectus.

M. The weighted average price of acquisition of Equity Shares by our Promoter in last one year preceding the date of this Prospectus is below:

Name of Promoter	Average price of Acquisition (₹)
Leena Kamat	7.45
Rajkumar Kamat	7.87

N. The average cost of acquisition of Equity Shares by our Promoter is:

Name of Promoter	Average price of Acquisition (₹)
Leena Kamat	7.24
Rajkumar Kamat	7.88

O. Our Company does not contemplate any issuance or placement of Equity Shares from the date of this Prospectus till the listing of the Equity Shares.

P. Our Company has not issued any Equity Shares for consideration other than cash in the one year preceding the date of this Prospectus except as stated under chapter titled “*Capital Structure*” beginning from page 48 of this Prospectus.

Q. Our Company has not undertaken a split or consolidation of the Equity Shares in the one year preceding the date of this Prospectus except as stated under chapter titled “*Capital Structure*” beginning from page 48 of this Prospectus.

R. Our company has not applied or received any exemption from complying with any provisions of securities laws by SEBI

## SECTION III – RISK FACTORS

An investment in Equity Shares involves a high degree of financial risk. You should carefully consider all information in this Prospectus, including the risks described below, before making an investment in our Equity Shares. The risk factors set forth below do not purport to be complete or comprehensive in terms of all the risk factors that may arise in connection with our business or any decision to purchase, own or dispose of the Equity Shares. This section addresses general risks associated with the industry in which we operate and specific risks associated with our Company. Any of the following risks, as well as the other risks and uncertainties discussed in this Prospectus, could have a material adverse effect on our business and could cause the trading price of our Equity Shares to decline and you may lose all or part of your investment.

This Prospectus also contains forward-looking statements that involve risks and uncertainties. We have described the risks and uncertainties that our management believes are material, but these risks and uncertainties may not be the only ones we face. Additional risks and uncertainties, including those we are not aware of or deem immaterial, may also result in decreased revenues, increased expenses or other events that could result in a decline in the value of our Equity Shares. In making an investment decision, prospective investors must rely on their own examination of our Company and the Issue, including the merits and risks involved. Unless specified or quantified in the relevant risk factors below, we are not in a position to quantify the financial or other implications of any of the risks described in this section. Investors are advised to read the risk factors carefully before taking an investment decision in this Issue. Investors should not invest in this Issue unless they are prepared to accept the risk of losing all or part of their investment, and they should consult their tax, financial and legal advisors about the particular consequences to you of an investment in the Equity Shares.

To obtain a better understanding of our business, you should read this section in conjunction with other chapters of this Prospectus, including the chapters titled “Our Business”, Management’s Discussion and Analysis of Financial Condition and Results of Operations”, “Industry Overview” and “Financial Information” on page nos. 72, 141, 66 and 121 respectively of this Prospectus, together with all other financial information contained in this Prospectus. Our actual results could differ materially from those anticipated in these forward looking statements as a result of certain factors, including the considerations described below and elsewhere in this Prospectus.

In this section, unless the context otherwise requires, a reference to the “Company”, “we”, “us” or “our” is a reference to EP Biocomposites Limited. Unless otherwise stated, the financial data in this chapter is derived from our Restated Financial Statements for the years ended March 31, 2022, 2021 and 2020 as included in “Financial Information” on page no. 121 of this Prospectus.

### **Materiality**

The Risk factors have been determined on the basis of their materiality. The following factors have been considered for determining the materiality.

1. Some events may have material impact quantitatively;
2. Some events may have material impact qualitatively instead of quantitatively.
3. Some events may not be material individually but may be found material collectively.
4. Some events may not be material at present but may be having material impact in future.

### **INTERNAL RISKS**

- 1. Some of our solutions are license based; any failure on our part to successfully retain the license would have a material adverse effect on our operation and profitability.***

Some of our sanitation solutions are based on the patented “bio-digester” technology developed by DRDO (Defence Research and Development Organization). We are a licensee (through transfer of technology) and have partnered DRDO for technology commercialization for large-scale deployment of sanitation systems. Though the license is perpetual in nature, any failure on our part to retain the license could materially affect our business. Further any subsequent introduction of royalty claimed by DRDO will increase our cost and adversely affect our profitability as currently there is no royalty levied by DRDO on the product sale.

2. ***Substantial portion of our revenue has been dependent upon our few clients. The loss of any one or more of our major clients would have a material effect on our business operations and profitability.***

Our customers include large corporate houses, trust & Industries. For the financial year ended March 31, 2022, March 31, 2021 and March 31, 2020, our top ten clients accounted for approximately 68.92% , 43.79% and 63.47% of our revenue from operations. However the loss of any significant client would have a material effect on our financial results. The company is adding high value new clients through Aqua Division. However we cannot assure you that we can maintain the historical levels of business from these clients/distributors or that we will be able to replace these clients/distributors in case we lose any of them. Furthermore, major events affecting our clients, such as changes in government policies and bankruptcy, change of management, mergers and acquisitions in other cases could impact our business. If any of our major client becomes bankrupt or insolvent, we may lose some or all of our business from that client and our receivable from that client would increase and may have to be written off, impacting our income and financial condition.

3. ***We do not have any agreement with the third party service providers to whom we outsource manufacturing of bio-digester tanks, also we are dependent on outside vendors for sanitary wares; consequently we are exposed to price and supply fluctuations for the same.***

Our Company relies on third parties for sanitary wares. Also, we outsource part of manufacturing of biodigester tanks to third party considering the additional business requirement. We outsource work to them on invoice basis and have no agreements with them. We also outsource to independent contractors at fair value determined by us. Further, we cannot assure you that our third party service providers will continue to be associated with us on reasonable terms, or at all. Since such third party service providers are not contractually bound to deal with us exclusively, we may face the risk of our competitors offering better terms to such third party service providers, which may cause them to cater to our competitors alongside, or even instead of us. Also, in the absence of any contract, they may discontinue their service on a short notice and our production process may be stalled or hindered due to this. We may have to rely on inexperienced or costlier or unprofessional processing units which may compromise the quality of our finished products. Consequently, we may be exposed to price and supply fluctuations in these areas which may have a material effect on our business, results of operations and financials.

4. ***Our cost of production is exposed to fluctuations in the prices of raw materials required for the manufacture of our products as well as their availability.***

Our company is exposed to fluctuations in the prices of various raw materials such as Glass Fiber, Polyester Resin, Stainless Steel, MS rods, Cement, Sand, Adhesives, Pigments etc. due to various reasons such as increased manufacturing costs of these materials, increase in transportation costs, changes in core prices of minerals as a natural resource, etc .We typically do not enter into any supply agreements with our suppliers and all the above mentioned raw materials are bought by our Company from various suppliers on an order-to-order basis. We may be unable to make adequate provisions for the price fluctuations and, consequently, any adverse fluctuations that we have not factored in or provided for may adversely affect the results of our operations and our financial conditions. The prices of two major raw materials i.e. resins and glass fibers have remained within the range except during the second wave of Covid -19. We also face the risks associated with compensating for or passing on such increase in our cost of production on account of such fluctuations in prices to our customers. Particularly, we face the risk of our competitors being able to sell the products at lower rates than us due to their economies of scales, if we pass on the increase in the cost of production to our customers through a corresponding increase in the price of our products in order to maintain our historical margins. Upward fluctuations in the prices of the various raw materials may thereby affect our margins and profitability, resulting in a material adverse effect on our overall business, financial condition and results of operations. For further details of various raw materials required, see “Our Business” on page no. 72 of this Prospectus.

5. ***We are dependent on third party transportation providers for the delivery of our products. Accordingly, continuing increases in transportation costs or unavailability of transportation services for them, as well the extent and reliability of Indian infrastructure may have an adverse effect on our business, financial condition, results of operations and prospects.***

The toilet super-structures and the bio-tanks are made in our plants and transported to the installation sites; and our team members install/assemble the bio-toilets at the customer site. We use third party transportation providers for the delivery. Transportation strikes could have an adverse effect on our receipt of raw materials and our ability to deliver our products to our customers. In addition, transportation costs in India have been steadily increasing over the past several years. Continuing increases in transportation costs or unavailability of transportation services for



our products may have an adverse effect on our business, financial condition, results of operations and prospects. The company will tie up with reputed logistic partners for seamless operations in future. Any deterioration of India's physical infrastructure would harm the national economy, disrupt the transportation of goods and supplies, and add costs to doing business in India. These problems could interrupt our business operations, which could have a material adverse effect on our results of operations and financial condition.

**6. Our Company has reported certain negative cash flows from its operating activity, investing activity and financing activity, details of which are given below. Sustained negative cash flow could impact our growth and business in the future.**

Our Company had reported certain negative cash flows from its operating activity, investing activity and financing activity in the period ended March 31, 2022 and previous years as per the restated financial statements and the same are summarized as under:

Particulars	For the Year Ended March 31,		
	2022	2021	2020
Net Cash Generated from Operating Activities	(429.11)	3.31	11.62
Net Cash Generated from Investing Activities	(45.82)	0.16	-
Net Cash Generated from Financing Activities	475.74	(0.25)	(0.05)

For details, please refer "Management's Discussion and Analysis of Financial Conditions and Results of Operations" on page no. 19 of this Prospectus. Cash flow of a company is a key indicator to show the extent of cash generated from operations to meet capital expenditure, pay dividends, repay loans and make new investments without raising finance from external resources. If our Company is not able to generate sufficient cash flows, it may adversely affect our business and financial operations.

**7. Our Promoter and Directors play key role in our functioning and we heavily rely on their knowledge and experience in operating our business and therefore, it is critical for our business that our Promoter and Directors remain associated with us.**

Our success also depends upon the services of our key managerial personnel and our ability to attract and retain key managerial personnel and our inability to attract them may affect our operations. We benefit from our relationship with our Promoter and Directors and our success depends upon the continuing services of our Promoter and Directors who have been responsible for the growth of our business and are closely involved in the overall strategy, direction and management of our business. Our Promoter and Directors have been actively involved in the day-to-day operations and management since the incorporation of the Company. Accordingly, our performance is heavily dependent upon the services of our Promoter and Directors. If our Promoter and Directors are unable or unwilling to continue in their present position, we may not be able to replace them easily or at all. Further, we rely on the continued services and performance of our key executives and senior management for continued success and smooth functioning of the operations of the Company. If we lose the services of any of our key managerial personnel, we may be unable to find suitable or qualified replacements, and may incur additional expenses to recruit and train new personnel, which could adversely affect our business operations and affect our ability to continue to manage and expand our business. Moreover, we do not maintain key person insurance to insure against the loss of key personnel. Our Promoter, along with the key managerial personnel, has over the years built relations with manufacturers, customers and other persons who are connected with us. The loss of their services could impair our ability to implement our strategy, and our business, financial condition, results of operations and prospects may be materially and adversely affected.

**8. The IPO Proceeds will be used to pay an interest free refundable security deposit to the owner/lessee of the manufacturing facility.**

Recently our Company has taken over the business of M/s OM Ventures with a vision to corporatize our business and to run the entire business under one roof. A Business Transfer Agreement dated August 31, 2021 has been entered into to give effect to the takeover of the business of M/s. OM Ventures (Proprietor Leena Kamat). Through Business Takeover Agreement, our company has taken over only business except real estate in order to save the excess expenses of the company for buying the property and other relevant expenses for transfer of the property. We believe that we currently need the Manufacturing facility on a lease hold basis. The land of the said premise is leased by GIDC to M/s OM Ventures. Hence, we have entered into a sub-leasing agreement dated August 13, 2021 for the land as well as building of manufacturing facility, with the owner/lessee of this land and building. Further this property is used by our company for obtaining debt and hence, we propose to pay an interest free refundable

security deposit to the owner/lessee of the manufacturing facility of ₹ 200.00 lakhs, in order to compensate for such land and asset being used by the company. Further, by paying a sizable deposit, this allows the company to keep our monthly lease costs low and hence helps us manage our cash flows and profitability better.

**9. *Some of the immovable properties used by us are on lease and leave and license basis. If we are unable to renew existing lease and leave and license or relocate operations on commercially reasonable terms, there may be an effect on our business, results of operations and prospects.***

We do not own the premises from where we operate. We have entered into sub lease agreements for our manufacturing unit/registered office at Plot No 57, Shed No D-2/12, Bicholim Industrial Estate, Bicholim, Goa 403504. This agreement is renewable based on the terms of the agreement. We have also entered into Leave and License agreement for our Corporate Office dated 31<sup>st</sup> December 2021 w.e.f. 1<sup>st</sup> January 2022. This agreement is renewable based on the terms of the agreement. Further, if we are unable to renew the agreements pursuant to which we occupy the premises on terms and conditions acceptable to us, or at all, we may have to relocate to other places and if we relocate our manufacturing unit and registered office as a result of any termination or non-renewal of our leases and rentals, we may incur additional cost as a result of such relocation. Any failure or difficulty faced by us in renewing leases, or disputes or other problems that we may face in the future with lessors may affect our business and prospects. For further details of our Properties, please refer to section titled “Our Business” beginning on Page no. 72 of this Prospectus.

**10. *We require certain approvals and licenses in the ordinary course of business and are required to comply with certain rules and regulations to operate our business, and the failure to obtain, retain and renew such approvals and licences or comply with such rules and regulations, and the failure to obtain or retain them in a timely manner or at all may adversely affect our operations.***

We require several statutory and regulatory permits, licenses and approvals to operate our business. Many of these approvals are granted for fixed periods of time and need renewal from time to time. Non-renewal of the said permits and licenses would adversely affect our Company’s operations, thereby having a material adverse effect on our business, results of operations and financial condition. There can be no assurance that the relevant authorities will issue any of such permits or approvals in the time-frame anticipated by us or at all. Our company is incorporated on January 17, 2020, as a public limited company under the provisions of the Companies Act, 2013. Our Company has recently acquired running business of M/s OM ventures (Proprietor Leena Kamat) w.e.f. August 31, 2021. Hence, earlier all the approvals were in the name of M/s OM Ventures. Our Company has made applications to an application to The Chief Inspector of Factories and Boilers for Factories license under Factories Act, 1948 for its premise situated at D2/12, Bicholim Industrial Estate Bicholim, North Goa- 403504. Further, some of our permits, licenses and approvals are subject to several conditions and we cannot provide any assurance that we will be able to continuously meet such conditions or be able to prove compliance with such conditions to the statutory authorities, which may lead to the cancellation, revocation or suspension of relevant permits, licenses or approvals. Any failure by us to apply in time, to renew, maintain or obtain the required permits, licenses or approvals, or the cancellation, suspension or revocation of any of the permits, licenses or approvals may result in the interruption of our operations and may have a material adverse effect on the business. If we fail to comply with all applicable regulations or if the regulations governing our business or their implementation change, we may incur increased costs, be subject to penalties or suffer a disruption in our business activities, any of which could adversely affect our results of operations. For further details, please see chapters titled “Key Industry Regulations and Policies” and “Government and Other Statutory Approvals” at page nos. 92 and 157 respectively of this Prospectus.

**11. *Failure to protect our intellectual property may adversely affect our reputation, goodwill and business Operations***

As on the date of this Prospectus, our Company has one (1) registered trademark  under class 11 registered with the registrar of trademarks. For further details please refer the chapter titled “Government and Other Approvals” beginning on page no.157 of this Prospectus. Any failure to renew registration of our registered trademarks may affect our right to use them in future. Our efforts to protect our intellectual property may not be adequate and any third party claim on any of our unprotected brands may lead to erosion of our business value and our reputation, which could adversely affect our operations. Third parties may also infringe or copy our registered trademarks. We may not be able to detect any unauthorized use or take appropriate and timely steps to enforce or protect our trademarks



Our corporate logo “” is registered in the name of our promoter Mr. Rajkumar Kamat. The said trademark is being used by the Company via a No Objection Certificate (“NOC”) granted by our promoter Rajkumar Kamat. If our promoter withdraws, refuses to renew or terminates this arrangement, we will not be able to make use of the said trademark and name in connection with our business. Any failure to renew registration of registered trademarks by our promoter may affect our right to use them in future. Further, we cannot assure that said trademark being used by the Company will not be invalidated or circumvented. For further details, pertaining to our intellectual property, please refer to the chapter titled “Our Business” beginning on page 72 of this Prospectus.

**12. We intend to repay certain loan facilities availed from our Director from the IPO Proceeds.**

One of the objects of the Issue is the repayment of certain loan facilities, in full or in part, availed by our Company. We intend to use the proceeds from the Issue to repay part of the loans availed from our Directors. As of March 31, 2022, we have availed an aggregate of Rs 224.01 lakhs of unsecured loans from them and these loans were utilized for working capital needs & other funding requirements of the Company from time to time. We intend to repay an aggregate of Rs 80.00 lakhs of the said outstanding loan. We believe that the proposed repayment will enable us to improve our debt-equity ratio and reduce the total unsecured loans. For details of the outstanding loans proposed for repayment or prepayment, in full or in part from the Net Proceeds, refer the chapter “Objects of the Issue” on page 56 of this Prospectus. The amount utilized to repay these loans will, therefore, not be available for investment in our business and will not result in any immediate increase in the value of your investment in our Equity Shares.

**13. Our Company has availed unsecured loan from our Directors / Promoters which is repayable on demand.**

Any demand from the lender for repayment of such unsecured loan may affect our cash flow and financial condition. Our Company, as per the restated financial statement as on March 31, 2022 has availed unsecured loans of Rs 224.01 lakhs out of which loan of Rs. 92.91 lakhs from Director carries interest@ 10.50% and is repayable in 120 EMIs. Further, Loan of 131.10 availed from Mr Rajkumar Kamat is an interest free loan and no terms of repayment have been stipulated. Sudden recall may disrupt our operations and also may force us to opt for high interest bearing funding, resulting in financial burden. Further, we will not be able to raise funds at short notice and thus result in shortage of working capital fund. For further details, please refer to the section “Unsecured Loans” under “Financial Statements” beginning on page no.121 of this Prospectus. Any demand for the repayment of such unsecured loans, may adversely affect our cash flow and financial condition.

**14. Our Company's manufacturing activities are labour intensive and depend on availability of skilled and unskilled labourers in large numbers. In case of unavailability of such labourers and / or inability to retain such personnel, our business operations could be affected.**

Our Company has employed 30 people as on March 31, 2022 all of whom are on our payrolls. The above includes employees in the top and middle management (including Executive Directors), and also employees who are part of manufacturing unit and office staff. Our operations and performance are labour intensive and depends on our ability to identify, attract and retain both skilled and unskilled labour. In case such labour is unavailable or we are unable to identify and retain such labourers, our business could be adversely affected.

**15. We have issued Equity Shares during the last year at a price that may be below the Issue Price.**

We have issued certain Equity Shares in the last twelve months, at a price that may be lower than the Issue Price. Details of such issuances are given in the table below:

Date of Allotment	No. of Equity Shares	Issue Price	Nature of Allotment	Allotted Person
September 27, 2021	8,02,500	Rs 10	Right Issue	Allotted only to Promoters i.e. Leena Kamat and Rajkumar Kamat

For Further details of equity shares issued, please refer to the section titled “Capital Structure” beginning on page no. 48 of this Prospectus

**16. Orders placed by customers may be delayed, modified, cancelled or not fully paid for by our customers, which may have an adverse effect on our business, financial condition and results of operations.**

We may encounter problems in executing the orders in relation to our products, or executing it on a timely basis. Moreover, factors beyond our control or the control of our customers, including delays or failure to obtain necessary permits, authorizations, permissions and other types of difficulties or obstructions, may result in the postponement of the delivery of products or cause its cancellation. Accordingly, it is difficult to predict with certainty if, when, and to what extent we may be able to deliver the orders placed. Failure to deliver products on time could lead to customers delaying or refusing to pay the amount, in part or full, which may adversely affect our business. In addition, even where a delivery proceeds as scheduled, it is possible that the contracting parties may default or otherwise fail to pay amounts owed. While we have not yet experienced any material delay, reduction in scope, cancellation, execution difficulty, delay or default in payment with regard to the orders placed with us, or any material disputes with customers in respect of any of the foregoing, any such adverse event in the future could materially harm our cash flow position and income. Any delay, modification, cancellation of order by our large customers may have material adverse effect on our financial condition and results of operations.

**17. There may be potential conflict of interests between our company and other venture or enterprises promoted by our promoter or directors.**

The Main Object Clause of some of our Group Companies and certain companies forming part of our Group companies viz. Epee Metal Goa Private Limited and Epee Bio Solutions Pvt Ltd permits them to undertake similar business to that of our business, which may create a potential conflict of interest and which in turn, may have an implication on our operations and profits. Though each company has its independent business, we cannot be assured that we shall be able to adopt necessary measures for mitigating these conflicts and hence the same if not managed well, could adversely affect our results of operations and financial condition. Also, our Company does not have any non-compete or such other agreement / arrangement with the above said companies. Presently, Epee Metal Goa Private Limited is engaged in the business of fire doors (which is not pursued by our Company) while the Epee Bio Solutions has very negligible business activities. For further details, please refer to the chapters titled ‘Our Business’, ‘Our Group Companies’, beginning on page nos.72 and 117, respectively and Annexure XX - Related Party Transactions” on page no. 121 of this Prospectus.

**18. Our business is dependent on our operating facilities. The loss or shutdown of our facilities could have a material adverse effect on our business, financial condition and results of operations**

Our facilities are at Bicholim Industrial Estate, Bicholim, Goa- 403504, and are subject to operating risks, such as shutdowns due to the breakdown of power supply or processes, performance below expected levels of output or efficiency, labour disputes, strikes, lockouts, disruption by extremist groups, or any other reason, and the need to comply with the directives and regulations of the Government of India (“GoI”) and relevant state government authorities. We are heavily reliant on our workers at unit. Our inability to continue to procure such services or any disputes with this group of labour could severely affect our operations and may cause under-utilisation of our capacities or a total shut down. Our operations involve a significant degree of integration, and our results of operations are dependent on the successful operation of each facility. Although we take precautions to minimize the risk of any significant operational problems at our facilities, our business, financial condition, results of operations and prospects may be adversely affected by any disruption of operations at our facilities.

**19. We have not made any alternate arrangements for meeting our regular working capital requirements. If our operations do not generate the necessary cash flow, our working capital requirements may negatively affect our operations and financial performance.**

As on date, we have not made any alternate arrangements for meeting our working capital requirements. We meet our working capital requirements through our owned funds and internal accruals. Any shortfall in our net owned funds, internal accruals and our inability to raise debt would result in us being unable to meet our working capital requirements, which in turn will negatively affect our financial condition and results of operations.

**20. Our insurance coverage may prove inadequate to satisfy future claims against us.**

Our business & assets could suffer damage from fire, natural calamities, misappropriation or other causes, resulting in losses, which may not be covered by insurance. We cannot guarantee that the existing insurance that we have will be able to cover any unforeseen losses to its full extent or at all. Besides, if any uninsured losses occur, the aforementioned losses will not be compensated to any extent. If we are required to take new coverage, there can be

no assurance that a suitable coverage will be available on reasonable terms or will be available in sufficient amounts to cover one or more large claims, or that the insurer will not disclaim coverage as to any future claim. Presently, if we suffer a large uninsured loss our business, financial condition and results of operations may be adversely affected.

**21. *Changes in technology may render our current technologies obsolete or require us to make substantial capital investment.***

Our ability to remain competitive may be adversely affected by emerging technologies and our ability to adapt to such changes. Our technology and key infrastructure may become obsolete or may not be upgraded timely, hampering our operations and financial conditions and we may not have the competitive edge. Although we strive to keep our technology, equipment's and infrastructures in line with the latest technological standards, we may be required to implement new technology or upgrade the equipment's employed by us. Further, the costs in upgrading our technology and modernizing the equipment's are significant which could substantially affect our finances and operations. If we fail to exploit emerging technologies, it could have a material adverse effect on our business prospects, financial condition and results of operations.

**22. *We face competition in our business from organized and unorganized players, which may adversely affect our business operation and financial condition.***

We may have to confront pressures in respect of pricing; product quality etc. from the clients and such pressures may put strain on our profit margins, which may consequently affect the financial position of our Company. Competition emerges not only from the organized sector but also from the unorganized sector and from both small and big players. Our Competitiveness is also measured by the technology we adopt as the industry is rapidly growing in India. Our inability to compete with this intense competition; will have material adverse impact on our Company's financial position.

**23. *Our failure to accurately forecast demand or in case of order based procurements, any cancellation of orders or delay in supply of raw materials by suppliers to meet such orders, could result in an unexpected shortfall or surplus in the supply of our products resulting into higher inventory, which could adversely affect our operations and profitability.***

We maintain inventory of raw materials at our various units based on existing demand trends to meet a certain unexpected demand and also our production batches are set accordingly. We monitor the inventory levels based on our own projections of future demand. In the past, we have experienced high levels of inventory of Rs. 118.25 lakhs and Rs. 45 lakhs as per the restated financials as at March 31, 2022 and March 31, 2021 respectively to meet the demand. If we are unable to appropriately estimate the demand for our products for any reason, the same could result in surplus of inventory levels or unavailability of the same in high demand situations resulting in below potential sales. Additionally, in case of order based procurements, any cancellation of orders or delay in supply of raw materials by our suppliers to meet such orders, could also result in surplus or shortfall of our products, which could adversely affect our operations. Further, excess inventory of raw materials and finished products, subjects us to additional risks related to storage of the same, such as health and safety hazard and environmental damage and theft could adversely affect our operations and profitability.

**24. *Our Company has entered into certain related party transactions in the past and may continue to do so in the future, which may potentially involve conflicts of interest with the equity shareholders.***

Our Company has entered into certain transactions with our related parties, including our Promoter and Promoter Group. While we believe that all such transactions have been conducted on the arm's length basis, we cannot assure you that we might have obtained more favorable terms had such transactions been entered into with unrelated parties. Furthermore, it is likely that we may enter into related party transactions in the future. We cannot assure you that such transactions, individually or in the aggregate, will always be in the best interests of our minority shareholders and will not have an adverse effect on our business, results of operations, cash flows and financial condition. For details, please refer "Financial Statements – Annexure XXXII - Related Party Transactions" on page no. 121 of this Prospectus.



**25. *The outbreak of COVID-19 or outbreak of any other severe communicable disease could have a potential impact on our business, financial condition and results of operations.***

An outbreak of a novel strain of coronavirus (COVID-19) was recognized by the World Health Organization as a public health emergency of international concern on January 30, 2020, and as a pandemic on March 11, 2020. The outbreak of COVID-19 has significantly and adversely impacted and will likely continue to impact economic activity and has contributed to significant volatility in global financial markets and led to operational challenges. It is possible that the outbreak of COVID-19 will cause a prolonged global economic crisis, stagnation, recession or depression, despite monetary and fiscal interventions by governments and central banks globally. In particular, a number of governments and organizations have revised GDP growth forecasts for 2021 downwards in response to the economic slowdown caused by the spread of COVID-19, and it is possible that the COVID-19 pandemic will cause a prolonged global economic crisis or recession. In response to the COVID-19 outbreak, the governments of many countries, including India have taken preventive or protective actions, such as issuing advisories and imposing country or state wide lockdowns, including restrictions on travel and temporary closure of business operations and increased remote working protocols, which have significantly slowed down economic activity. On March 14, 2020, India declared COVID-19 as a “notified disaster” and imposed a nationwide lockdown announced on March 24, 2020. While there have been progressive relaxations and calibrated easing of lockdown measures by the Government, we cannot predict if stricter lockdowns will not be re-introduced or extended in the future. On account of the government imposed lockdown in India, operations at all of our manufacturing facilities were temporarily shut down with effect from March 24, 2020 and resumed operations in accordance with permissions from the local authorities. The COVID-19 pandemic and resulting government actions may affect our business, results of operations and financial condition, in the future, in a number of ways such as requiring a complete or partial closure of our operations. A strong base of loyal customers and diversified product range which caters to multiple customer segments like Hotels, Industry, Government besides Individuals & construction sector helped us continue our operations in spite of Covid. Increase in Raw material prices due to shortage in the market has affected our operations. Average of nearly 15% increase in raw material costs has impacted our bottom line; through the Top line has grown healthily. We continued our operations after making arrangements to meet the government’s requirements on sanitization, people movement and social distancing. However the prices are now slowly falling in places with economy opening up.

Further, due to the rising number of infected cases of COVID-19 in the country, there is no certainty if additional restrictions will be put back in place or if another lockdown would be re-imposed to control the spread of the pandemic. We cannot assure you that we may not face any difficulty in our operations due to such restrictions and such prolonged instances of lockdown may adversely affect our business, financial condition and results of operations. The outbreak, or threatened outbreak, of any severe communicable disease (particularly the COVID-19) could materially adversely affect overall business sentiment and environment, particularly if such outbreak is inadequately controlled. The spread of any severe communicable disease may also adversely affect the operations of our customers and suppliers, which could adversely affect our business, financial condition and results of operations. The outbreak of COVID-19 has resulted in authorities implementing several measures such as travel bans and restrictions, quarantines, and lockdowns. On account of the nationwide lockdown we experienced certain operational disruptions and we cannot predict the further impact COVID-19 may have on our operations, the operations of our customers, and those of our respective vendors and suppliers. A rapid increase in severe cases and deaths where measures taken by governments fail or are lifted prematurely, may cause significant economic disruption in India and in the rest of the world. The scope, duration and frequency of such measures and the adverse effects of COVID-19 remain uncertain and could be severe. Our ability to meet our ongoing disclosure obligations might be adversely affected, despite our best efforts. If any of our employees were suspected of contracting COVID-19 or any other epidemic disease, this could require us to quarantine some or all of these employees or disinfect the facilities used for our operations. In addition, our revenue and profitability could be impacted to the extent that a natural disaster, health epidemic or other outbreak harms the Indian and global economy in general.

The outbreak has significantly increased economic uncertainty. It is likely that the current outbreak or continued spread of COVID-19 will cause further economic slowdown and it is possible that it could cause a global recession. The spread of COVID-19 has caused us to modify our business practices (including employee travel, employee work locations, and cancellation of physical participation in meetings, events and conferences), and we may take further actions as may be required by government authorities or that we determine are in the best interests of our employees, customers, partners, and suppliers. There is no certainty that such measures will be sufficient to mitigate the risks posed by the outbreak, and we cannot predict the future impact of COVID-19 on our ability to perform critical functions. We are closely monitoring the impact of COVID-19 on all aspects of our business, but there can be no assurance that such monitoring will enable us to avoid part or all of any future impact from the



spread of COVID-19 or its consequences, including downturns in business sentiment generally or in our sector in particular. The degree to which COVID-19 impacts our results will depend on future developments, which are highly uncertain and cannot be predicted, including, but not limited to, the duration and spread of the outbreak, its severity, the actions taken to contain the outbreak or treat its impact, and how quickly and to what extent normal economic and operating conditions can resume. The above risks can threaten the safe operation of our facilities and cause disruption of operational activities, environmental harm, and loss of life, injuries and impact the wellbeing of our people. Further in case the lockdown is reinstated, it could result in muted economic growth or give rise to a recessionary economic scenario, in India and globally, which could adversely affect the business, prospects, results of operations and financial condition of our Company.

**26. *In addition to normal remuneration, other benefits and reimbursement of expenses our Directors (including our Promoter) and Key Management Personnel are interested in our Company to the extent of their shareholding and dividend entitlement in our Company.***

Some of our Directors (including our Promoter) and Key Management Personnel are interested in our Company to the extent of their shareholding and dividend entitlement in our Company, in addition to normal remuneration, incentives or benefits and reimbursement of expenses. We cannot assure you that our Directors or our Key Management Personnel would always exercise their rights as Shareholders to the benefit and best interest of our Company. As a result, our Directors will continue to exercise significant control over our Company, including being able to control the composition of our board of directors and determine decisions requiring simple or special majority voting, and our other Shareholders may be unable to affect the outcome of such voting. Our Directors may take or block actions with respect to our business, which may conflict with our best interests or the interests of other minority Shareholders, such as actions with respect to future capital raising or acquisitions. We cannot assure you that our Directors will always act to resolve any conflicts of interest in our favour, thereby adversely affecting our business and results of operations and prospects.

**27. *If we are not able to manage our growth or to successfully implement our business plan, it could have an effect on our results of operations and financial condition.***

The success of our business will depend greatly on our ability to effectively implement our business and growth strategy. Our growth strategy involves focusing on Optimal Utilization of Resources and to develop relationships with customer and suppliers. For further details, see the section titled “Our Business – Our Strategies” on page no. 72 of this Prospectus. Our success in implementing our growth strategies may be affected by:

- Partnerships with industry and non-governmental players
- Market Expansion
- Investing in Human Resources and Building a Professional Organization
- Networking
- Strengthening Supply Chain
- Digital Marketing

If our Company is not able to execute our strategy on time and within our estimated budget, or that our expansion and development plans will increase our profitability. Any of these factors could impact our results of operations. Further, we expect our growth strategy to place significant demands on our management, financial and other resources and require us to continue developing and improving our operational, financial and other internal controls. Our inability to manage our business and implement our growth strategy could have an effect on our business, financial condition and profitability.

**28. *Our Company has not paid any dividends till now and there can be no assurance that we will pay dividends in future. Our ability to pay dividends in the future will depend upon a variety of factors such as future earnings, financial condition, cash flows, working capital requirements, and restrictive covenants in our financing arrangements.***

Our Company has not paid any dividends till now and there can be no assurance that we will pay dividends in future. Our ability to pay dividends in the future will depend on our earnings, financial condition and capital requirements. Dividends distributed by us will attract dividend distribution tax at rates applicable from time to time. There can be no assurance that we will generate sufficient income to cover our operating expenses and pay dividends to our shareholders, or at all. Our ability to pay dividends could also be restricted under the existing or certain financing arrangements that we may enter into.

- 29. *Our Company might be unable to meet certain delivery obligations including timelines of delivery, due to which, it could become liable to claims by customers, suffer adverse publicity and incur substantial costs, which in turn could adversely affect our results of operations.***

Many of our orders involve providing services that are critical to the operations of our customers business. Any failure or defect in services could result in a claim against us for damages, regardless of our responsibility for such a failure or defect. Our Company has commitments for safe and timely delivery of the products. Any failure to meet the scheduled timelines set by our customers or loss or damage may lead to our customers raising claims against us. Although Our Company is attempting to limit its contractual liability for all the damages, including consequential damages, while rendering the services, our Company cannot be assured that the limitations on liability it provides for, in the service contracts will be enforceable in all cases.

- 30. *Our Promoter has extended personal guarantees in connection with certain of our debt facilities. There can be no assurance that such personal guarantees will be continued to be provided by our Promoter in the future or can be called at any time, affecting the financial.***

Our Promoter has provided personal guarantees for our borrowings to secure our loans. If any of these guarantees are revoked, our lenders may require alternative guarantees or collateral or cancellation of such facilities, entailing repayment of amounts outstanding under such facilities. If we are unable to procure alternative guarantees satisfactory to our lenders, we may need to seek alternative sources of capital, which may not be available to us at commercially reasonable terms or at all, or to agree to more onerous terms under our financing agreements, which may limit our operational flexibility. Accordingly, our business, financial condition, results of operations, cash flows and prospects may be adversely affected by the revocation of all or any of the personal guarantees provided by our Promoter in connection with our Company's borrowings.

- 31. *Our Promoter and Promoter Group will continue to retain majority shareholding in us after the Issue, which will allow them to exercise significant influence over us and potentially create conflicts of interest.***

After the completion of Initial Public issue of 5,04,000 new equity shares to general public still, our Promoter and Promoter Group may beneficially own approximately 69.40% of our post-Issue equity share capital. As a result, the Promoter and Promoter Group may have the ability to control our business including matters relating to any sale of all or substantially all of our assets, the timing and distribution of dividends and the election or termination of appointment of our officers and directors. This control could delay, defer or prevent a change in control of the Company, impede a merger, consolidation, takeover or other business combination involving the Company, or discourage a potential acquirer from making a tender offer or otherwise attempting to obtain control of the Company even if it is in the Company's best interest. In addition, for so long as the Promoter Group continues to exercise significant control over the Company, they may influence the material policies of the Company in a manner that could conflict with the interests of our other shareholders. The Promoter Group may have interests that are adverse to the interests of our other shareholders and may take positions with which our other shareholders do not agree.

- 32. *Employee misconduct, errors or fraud could expose us to business risks or losses that could adversely affect our business prospects, results of operations and financial condition.***

Employee misconduct, errors or frauds could expose us to business risks or losses, including regulatory sanctions, penalties and serious harm to our reputation. Such employee misconduct includes breach in security requirements, misappropriation of funds, hiding unauthorized activities, failure to observe our stringent operational standards and processes, and improper use of confidential information. It is not always possible to detect or deter such misconduct, and the precautions we take to prevent and detect such misconduct may not be effective. In addition, losses caused on account of employee misconduct or misappropriation of petty cash expenses and advances may not be recoverable, which may result in write-off of such amounts and thereby adversely affecting our results of operations. Our employees may also commit errors that could subject us to claims and proceedings for alleged negligence, as well as regulatory actions in which case, our reputation, business prospects, results of operations and financial condition could be adversely affected.

- 33. *Any disproportionate increase in labour costs including increase in wage/salary demand, labour unrest or labour claims arising from accidents may adversely affect our business operations and financial conditions.***

Our increasing business operations may require our employee strength to increase in future. In the past our Company has not experienced any labour unrest, but there is no assurance that it will not experience the same at

any time in the future. Also, there is a possibility that the labour costs increase disproportionately due to increase in wage/salary demand. In this event, if our Company is unable to pass on the increased costs to our customers, our business operations and financial conditions may be adversely affected.

**34. *In the event there is any delay in the completion of the Issue, there would be a corresponding delay in the completion of the objects / schedule of implementation of this Issue which would in turn affect our revenues and results of operations.***

The funds that we receive would be utilized for the Objects of the Issue as has been stated in the Chapter “Objects of the Issue” on page no.56 of this Prospectus. The proposed schedule of implementation of the objects of the Issue is based on our management’s estimates. If the schedule of implementation is delayed for any other reason whatsoever, including any delay in the completion of the Issue, we may have to revise our business, development and working capital plans resulting in unprecedented financial mismatch and this may adversely affect our revenues and results of operations.

**35. *The rate of interest for the loans obtained by us from the bank is variable and any increase in interest rates may adversely affect our results of operations and financial condition.***

Our Company is susceptible to changes in interest rates and the risks arising there from. Our sanction letters provide for interest at variable rates with a provision for the periodic resetting of interest rates. Further the lenders are entitled to change the applicable rate of interest, which is a combination of a base rate that depends upon the policies of the RBI and a contractually agreed spread, and in the event of an adverse change in our Company’s credit risk rating. For further details of interest payable on our borrowings, please refer to the chapter titled “Financial Indebtedness” on page no.151 of this Prospectus Further, in recent years, the Government of India have taken measures to control inflation, which have included tightening the monetary policy by raising 23 interest rates. As such, any increase in interest rates may have an adverse effect on our business, results of operations, cash flows and financial condition.

**36. *The requirements of being a public listed company may strain our resources and impose additional requirements.***

We are not a listed Company and have not, historically, been subjected to the increased scrutiny of our affairs by shareholders, regulators and the public at large that is associated with being a listed company. As a listed company, we will incur significant legal, accounting, corporate governance and other expenses that we did not incur as an unlisted company. We will be subject to the listing agreements with the Stock Exchanges and compliances of SEBI Listing Regulations which will require us to file audited annual and unaudited half yearly and limited review reports with respect to our business and financial condition. If we experience any delays, we may fail to satisfy our reporting obligations and/or we may not be able to readily determine and accordingly report any changes in our results of operations as promptly as other listed companies which may adversely affect the financial position of the Company.

As a listed company, we will need to maintain and improve the effectiveness of our disclosure controls and procedures and internal control over financial reporting, including keeping adequate records of daily transactions to support the existence of effective disclosure controls and procedures, internal control over financial reporting and additional compliance requirements under the Companies Act, 2013. In order to maintain and improve the effectiveness of our disclosure controls and procedures and internal control over financial reporting, significant resources and management oversight will be required. As a result, management’s attention may be diverted from other business concerns, which could adversely affect our business, prospects, financial condition and results of operations. In addition, we may need to hire additional legal and accounting staff with appropriate listed company experience and technical accounting knowledge and we cannot assure you that we will be able to do so in a timely manner.

- 37. Our management will have broad discretion in how we apply the Net Proceeds, including interim use of the Net Proceeds, and there is no assurance that the objects of the Issue will be achieved within the time frame expected or at all, or that the deployment of the Net Proceeds in the manner intended by us will result in any increase in the value of your investment. Further, the funding plan has not been appraised by any bank or financial institution and is not subject to any monitoring by any independent agency. Our Company's management will have flexibility in utilizing the Net Proceeds from the Issue. Any variation in the utilization of our Net Proceeds as disclosed in this Prospectus would be subject to certain compliance requirements, including prior shareholders' approval.**

Our Company intends to use the Net Proceeds from the Fresh Issue for the purposes described in “Objects of the Issue” on page 56 of this Prospectus. In terms of Regulation 262 of the SEBI (ICDR) Regulations, we are not required to appoint a monitoring agency since the Issue size is not in excess of ₹ 10,000 lakhs. The management of our Company will have discretion to use the Net Proceeds from the Issue, and investors will be relying on the judgment of our Company's management regarding the application of the Net Proceeds from the Issue. The funding plans are in accordance with our own estimates and have not been appraised by any bank, financial institution or any other external agency. Our Company may have to revise its management estimates from time to time on account of various factors beyond its control, such as market conditions, competitive environment and consequently its requirements may change. Additionally, various risks and uncertainties, including those set forth in this section may limit or delay our Company's efforts to use the Net Proceeds from the Issue to achieve profitable growth in its business. Our Board will have significant flexibility in temporarily investing the Net Proceeds of the Issue. Accordingly, the use of the Net Proceeds for purposes identified by our management may not result in actual growth of its business, increased profitability or an increase in the value of your investment.

Further, pursuant to Section 27 of the Companies Act 2013, any variation in the objects would require a special resolution of the Shareholders and would be required to provide an exit opportunity to the shareholders who do not agree with our proposal to change the objects of the Issue, at a price and manner as specified in the SEBI ICDR Regulations. Additionally, the requirement on Promoters or controlling shareholders to provide an exit opportunity to such dissenting shareholders may deter the Promoters or controlling shareholders from agreeing to the variation of the proposed utilisation of our Net Proceeds, even if such variation is in our interest. Further, we cannot assure you that our Promoters or the controlling shareholders will have adequate resources at their disposal at all times to enable them to provide an exit opportunity at the price which may be prescribed by SEBI. Accordingly, prospective investors in this Issue will need to rely upon our management's judgment with respect to the use of Net Proceeds. If we are unable to enter into arrangements for utilization of Net proceeds as expected and assumed by us in a timely manner or at all, we may not be able to derive the expected benefits from the proceeds of the Issue and our business and financial results may suffer.

## **RISKS RELATING TO THE EQUITY SHARES AND THE ISSUE**

- 38. Any future issuance of Equity Shares may dilute your shareholding and sales of our Equity Shares by our Promoter or other major shareholders may adversely affect the trading price of the Equity Shares.**

Any future issuance of the Equity Shares, convertible securities or securities linked to the Equity Shares by us, including through exercise of employee stock options may dilute your shareholding in our Company, may lead to the dilution of investors' shareholdings in our Company. Any future equity issuances by us or sales of our Equity Shares by our Promoters or other significant shareholders may adversely affect the trading price of the Equity Shares, which may lead to other adverse consequences for us including difficulty in raising debt or equity financing. In addition, any perception by investors that such issuances or sales might occur may also affect the trading price of our Equity Shares. We cannot assure you that we will not offer Equity Shares or that our shareholders will not dispose of, pledge or encumber their Equity Shares in the future.

- 39. The Equity Shares have never been publicly traded, and, after the Issue, the Equity Shares may experience price and volume fluctuations, and an active trading market for the Equity Shares may not develop. Further, the price of the Equity Shares may be volatile, and you may be unable to resell the Equity Shares at or above the Issue Price, or at all.**

Prior to the Issue, there has been no public market for the Equity Shares, and an active trading market on the Stock Exchanges may not develop or be sustained after the Issue. Listing and quotation does not guarantee that a market for the Equity Shares will develop, or if developed, the liquidity of such market for the Equity Shares. The Issue Price of the Equity Shares is proposed to be determined through a book-building process and may not be indicative of the market price of the Equity Shares at the time of commencement of trading of the Equity Shares or at any

time thereafter. The market price of the Equity Shares may be subject to significant fluctuations in response to, among other factors, variations in operating results of our Company, market conditions specific to the industry we operate in, developments relating to India, volatility in securities markets in jurisdictions other than India, variations in the growth rate of financial indicators, variations in revenue or earnings estimates by research publications, and changes in economic, legal and other regulatory factors.

**40. *Foreign investors are subject to foreign investment restrictions under Indian law that limits our ability to attract foreign investors, which may adversely impact the market price of the Equity Shares.***

Under the foreign exchange regulations currently in force in India, transfer of shares between non-residents and residents are freely permitted (subject to certain exceptions) if they comply with the pricing guidelines and reporting requirements specified by the RBI. If the transfer of shares, which are sought to be transferred, is not in compliance with such pricing guidelines or reporting requirements or fall under any of the exceptions referred to above, then the prior approval of the RBI will be required. Additionally, shareholders who seek to convert the Rupee proceeds from a sale of shares in India into foreign currency and repatriate that foreign currency from India will require a no objection/ tax clearance certificate from the income tax authority. There can be no assurance that any approval required from the RBI or any other government agency can be obtained on any particular terms or at all.

**41. *Investors can be subject to Indian taxes arising out of capital gains on the sale of the Equity Shares.***

Under current Indian tax laws, capital gains arising from the sale of equity shares within 12 months in an Indian company are classified as short term capital gains and generally taxable. Any gain realized on the sale of listed equity shares on a stock exchange that are held for more than 12 months is considered as long-term capital gains and is taxable at 10%, in excess of ₹ 1,00,000. Any long-term gain realized on the sale of equity shares, which are sold other than on a recognized stock exchange and on which no STT has been paid, is also subject to tax in India. Capital gains arising from the sale of equity shares are exempt from taxation in India where an exemption from taxation in India is provided under a treaty between India and the country of which the seller is resident. Generally, Indian tax treaties do not limit India's ability to impose tax on capital gains. As a result, residents of other countries may be liable to pay tax in India as well as in their own jurisdiction on a gain on the sale of equity shares.

**42. *The ability of Indian companies to raise foreign capital may be constrained by Indian law.***

As an Indian company, we are subject to exchange controls that regulate borrowing in foreign currencies, including those specified under FEMA. Such regulatory restrictions limit our financing sources and hence could constrain our ability to obtain financing on competitive terms. In addition, we cannot assure you that any required approvals for borrowing in foreign currency will be granted to us without onerous conditions, or at all. Such, and other, limitations on raising foreign capital may adversely affect our business growth, results of operations, and financial condition.

## **EXTERNAL RISK FACTORS**

**43. *Changes in government regulations or their implementation could disrupt our operations and adversely affect our business and results of operations.***

Our business and industry is regulated by different laws, rules and regulations framed by the Central and State Government. These regulations can be amended/ changed on a short notice at the discretion of the Government. If we fail to comply with all applicable regulations or if the regulations governing our business or their implementation change adversely, we may incur increased costs or be subject to penalties, which could disrupt our operations and adversely affect our business and results of operations.

**44. *Global economic, political and social conditions may harm our ability to do business, increase our costs and negatively affect our stock price.***

Global economic and political factors that are beyond our control, influence forecasts and directly affect performance. These factors include interest rates, rates of economic growth, fiscal and monetary policies of governments, inflation, deflation, foreign exchange fluctuations, consumer credit availability, fluctuations in commodities markets, consumer debt levels, unemployment trends and other matters that influence consumer confidence, spending and tourism. Increasing volatility in financial markets may cause these factors to change with a greater degree of frequency and magnitude, which may negatively affect our stock prices.



**45. *Terrorist attacks, civil unrest and other acts of violence or war involving India and other countries could adversely affect the financial markets and our business.***

Terrorist attacks and other acts of violence or war may negatively affect the Indian markets on which our Equity Shares will trade and also adversely affect the worldwide financial markets. These acts may also result in a loss of business confidence, impede travel and other services and ultimately adversely affect our business. In addition, any deterioration in relations between India and neighboring countries might result in investor concern about stability in the region, which could adversely affect the price of our Equity Shares. India has also witnessed civil disturbances in recent years and it is possible that future civil unrest as well as other adverse social, economic and political events in India could have a negative impact on the value of share prices generally as well as the price of our Equity Shares. Such incidents could also create a greater perception that investment in Indian companies involves a higher degree of risk and could have an adverse impact on our business and the price of our Equity Shares.

**46. *A decline in economic growth or political instability nationally or internationally or changes in the Government in India could adversely affect our business.***

Our performance and the growth of our business are necessarily dependent on the health and performance of the overall Indian economy. In the recent past, Indian economy has been affected by global economic uncertainties and liquidity crisis, domestic policy and political environment, volatility in interest rates, currency exchange rates, commodity and electricity prices, adverse conditions affecting agriculture, rising inflation rates and various other factors. Risk management initiatives by banks and lenders in such circumstances could affect the availability of funds in the future or the withdrawal of our existing credit facilities. The Indian economy is undergoing many changes and it is difficult to predict the impact of certain fundamental economic changes on our business. Conditions outside India, such as a slowdown or recession in the economic growth of other major countries, especially the United States, have an impact on the growth of the Indian economy. Additionally, an increase in trade deficit, a downgrading in India's sovereign debt rating or a decline in India's foreign exchange reserves could negatively affect interest rates and liquidity, which could adversely affect the Indian economy and our business. Any downturn in the macroeconomic environment in India could adversely affect our business, financial condition, results of operation and the trading price of our Equity Shares. Volatility, negativity, or uncertain economic conditions could undermine the business confidence and could have a significant impact on our results of operations. Changing demand patterns from economic volatility and uncertainty could have a significant negative impact on our results of operations.

Further, our performance and the market price and liquidity of the Equity Shares may be affected by changes in exchange rates and controls, interest rates, government policies, taxation, social and ethnic instability and other political and economic developments affecting India. The GoI has traditionally exercised and continues to exercise a significant influence over many aspects of the economy. Our business, the market price and liquidity of the Equity Shares may be affected by changes in GoI policy, taxation, social and civil unrest and other political, economic or other developments in or affecting India.

**47. *We are subject to regulatory, economic, social and political uncertainties and other factors beyond our control.***

We are incorporated in and our operations are in India. As a result, we are highly dependent on prevailing economic conditions in India and our results of operations are significantly affected by factors influencing the Indian economy.

Factors that may adversely affect the Indian economy, and hence our results of operations, may include: political instability, terrorism or military conflict in India or in countries in the region or globally, including in India's various neighboring countries;

- occurrence of natural or man-made disasters;
- any increase in Indian interest rates or inflation;
- any exchange rate fluctuations;
- any scarcity of credit or other financing in India, resulting in an adverse impact on economic conditions in India and scarcity of financing for our expansions;
- changes in India's tax, trade, fiscal or monetary policies;
- prevailing regional conditions,
- any downgrading of India's debt rating by a domestic or international rating agency;



- financial instability in financial markets; and
- Other significant regulatory or economic developments in or affecting India.

In addition, any slowdown or perceived slowdown in the Indian economy, or in specific sectors of the Indian economy, could adversely affect our business, results of operations and financial condition and the price of the Equity Shares.

**48. *If there is any change in tax laws or regulations, or their interpretation, such changes may significantly affect our financial statements for the current and future years, which may have a material adverse effect on our financial position, business and results of operations.***

Having our business operations in multiple jurisdictions, we are subject to varying central and state tax regimes. The applicable categories of taxes and tax rates also vary significantly from jurisdiction to jurisdiction, which may be amended from time to time. The final determination of our tax liabilities involves the interpretation of local tax laws and related regulations in each country as well as the significant use of estimates and assumptions regarding the scope of future operations and results achieved and the timing and nature of income earned, and expenditure incurred. Our business and financial performance may be adversely affected by unfavorable changes in or interpretations of existing, or the promulgation of new laws, rules and regulations applicable to us and our business or the regulator enforcing them in any one of those countries may adversely affect our results of operations.

To the extent that we are entitled to certain tax benefits in India which are available for a limited period of time, our profitability will be affected if such benefits will no longer be available, or are reduced or withdrawn prematurely or if we are subject to any dispute with the tax authorities in relation to these benefits or in the event we are unable to comply with the conditions required to be complied with in order to avail ourselves of each of these benefits. Please see “*Statement of Special Tax Benefits*” on page 63 of this Prospectus for details in relation to possible tax benefits available to our Company. In the event that any adverse development in the law or the manner of its implementation affects our ability to benefit from these tax incentives, our business, results of operations, financial condition and prospects may be adversely affected.

Changes in the operating environment, including changes in tax law, could impact the determination of our tax liabilities for any given tax year. Taxes and other levies imposed by the Government of India that affect our industry include income tax, goods and services tax and other taxes, duties or surcharges introduced from time to time. The tax scheme in India is extensive and subject to change from time to time and any adverse changes in any of the taxes levied by the Government of India may adversely affect our competitive position and profitability. We cannot assure you that the Government of India may not implement new regulations and policies which will require us to obtain approvals and licenses from the Government of India and other regulatory bodies or impose onerous requirements and conditions on our operations. Any such changes and the related uncertainties with respect to the applicability, interpretation and implementation of any amendment to, or change to governing laws, regulation or policy in the countries in which we operate may materially and adversely affect our business, results of operations and financial condition. In addition, we may have to incur expenditure to comply with the requirements of any new regulations, which may also materially harm our results of operations. We are also subject to these risks in all our overseas operations depending on each specific country. Any unfavorable changes to the laws and regulations applicable to us could also subject us to additional liabilities. As a result, any such changes or interpretations may adversely affect our business, financial condition and financial performance. Further, changes in capital gains tax or tax on capital market transactions or sale of shares may affect investor returns.

**49. *Any adverse change in India's credit rating by an international rating agency could materially adversely affect our business and profitability.***

India's sovereign rating is Baa3 with a “stable” outlook (Moody's), BBB-with a “stable” outlook (S&P) and BBB-with a “Stable” outlook (Fitch). India's sovereign rating could be downgraded due to various factors, including changes in tax or fiscal policy or a decline in India's foreign exchange reserves, which are outside our control. Any adverse change in India's credit ratings by international rating agencies may adversely impact the Indian economy and consequently our ability to raise additional financing, and the interest rates and other commercial terms at which such additional financing is available. This could have an adverse effect on our business and financial performance, ability to obtain financing for capital expenditures and the price of the Equity Shares

**50. *If inflation were to rise in India, we might not be able to increase the prices of our services at a proportional rate in order to pass costs on to our customers and our profits might decline.***

Inflation rates in India have been volatile in recent years, and such volatility may continue in the future. India has experienced high inflation in the recent past. Increased inflation can contribute to an increase in interest rates and increased costs to our business, including increased costs of transportation, wages, raw materials and other expenses relevant to our business. High fluctuations in inflation rates may make it more difficult for us to accurately estimate or control our costs. Any increase in inflation in India can increase our expenses, which we may not be able to pass on to our customers, whether entirely or in part, and may adversely affect our business, cash flows and financial condition. In particular, we might not be able to reduce our costs or increase the amount of commission to pass the increase in costs on to our customers. In such case, our business, results of operations, cash flows and financial condition may be adversely affected. Further, the Government of India has previously initiated economic measures to combat high inflation rates, and it is unclear whether these measures will remain in effect. There can be no assurance that Indian inflation levels will not worsen in the future.

***51. Instability in financial markets could materially and adversely affect our results of operations and financial condition.***

The Indian economy and financial markets are significantly influenced by worldwide economic, financial and market conditions. Any financial turmoil, especially in the United States of America or Europe, may have a negative impact on the Indian economy. Although economic conditions differ in each country, investors' reactions to any significant developments in one country can have adverse effects on the financial and market conditions other countries. A loss in investor confidence in the financial systems, particularly in other emerging markets, may cause increased volatility in Indian financial markets.

The global financial turmoil, an outcome of the sub-prime mortgage crisis which originated in the United States of America, led to a loss of investor confidence in worldwide financial markets. Indian financial markets have also experienced the contagion effect of the global financial turmoil, evident from the sharp decline in NIFTY, NSE's benchmark index. Any prolonged financial crisis may have an adverse impact on the Indian economy and us, thereby resulting in a material and adverse effect on our business, operations, financial condition, profitability and price of our Equity Shares.

## SECTION IV – INTRODUCTION

### THE ISSUE

<b>Equity Shares<sup>(1)</sup> :</b> Present Issue of Equity Shares by our Company <sup>(2)</sup>	5,04,000 Equity Shares of face value of ₹ 10 each for cash at a price of ₹126 per Equity Share aggregating to ₹ 635.04 lakhs
<b>Of which:</b>	
<b>Issue Reserved for the Market Maker</b>	28,000 Equity Shares of face value of ₹10 each for cash at a price of ₹126 per Equity Share aggregating to ₹ 35.28 lakhs.
<b>Net Issue to Public</b>	4,76,000 Equity Shares of face value of ₹ 10 each for cash at a price of ₹126 per Equity Share aggregating to ₹599.76 lakhs.
	<b>Of which<sup>(3)</sup>:</b>
	2,38,000 Equity Shares of ₹ 10 each at a price of ₹ 126 per Equity Share will be available for allocation for Investors of up to ₹ 2.00 lakhs
	2,38,000 Equity Shares of ₹ 10 each at a price of ₹ 126 per Equity Share will be available for allocation for Investors of above ₹ 2.00 lakhs
<b>Equity shares outstanding prior to the Issue</b>	11,77,500 Equity Shares of face value of ₹10 each
<b>Equity shares outstanding after the Issue</b>	16,81,500 Equity Shares of face value of ₹10 each
<b>Use of Net Proceeds</b>	Please refer to the section titled " <i>Objects of the Issue</i> " beginning on page no. 56 of this Prospectus.

<sup>(1)</sup> This Issue is being made in terms of Chapter IX of the SEBI (ICDR) Regulations, 2018, as amended from time to time. For further details, please see the section titled "Issue Information" beginning on page no. 170 of this Prospectus.

<sup>(2)</sup> The present Issue has been authorized pursuant to a resolution of our Board dated January 7, 2022 and by Special Resolution passed under Section 62(1)(C) of the Companies Act, 2013 at an Extra-Ordinary General Meeting of our shareholders held with a shorter notice on January 10, 2022.

<sup>(3)</sup> The allocation of the net Issue to the public category shall be made as per the requirements of Regulation 253(2) of SEBI (ICDR) Regulations, as amended from time to time:

a) Minimum fifty percent to retail individual investors; and

b) Remaining to

(i) Individual applicants other than retail individual investors; and

(ii) Other investors including corporate bodies or institutions, irrespective of the number of specified securities applied for

The unsubscribed portion in either of the categories specified in (a) or (b) above may be allocated to the applicants in the other category.

If the retail individual investor category is entitled to more than fifty per cent on proportionate basis, accordingly the retail individual investors shall be allocated that higher percentage.

For further details please refer to the chapter titled "Issue Structure" beginning on page no. 176 of this Prospectus.

**SUMMARY OF FINANCIAL INFORMATION**
**Annexure I**  
**STATEMENT OF ASSETS AND LIABILITIES, AS RESTATED**
*(Rs. in lakhs)*

Particulars	Annexure No	Financial Year Ended March		
		2022	2021	2020
<b>EQUITY AND LIABILITIES</b>				
<b>1. Shareholder's funds</b>				
a) Share Capital	VI	117.75	5.00	5.00
b) Reserves and surplus	VII	82.09	33.65	(2.15)
<b>Total Shareholder's Fund (1)</b>		<b>199.84</b>	<b>38.65</b>	<b>2.85</b>
<b>2. Share application money pending allotment</b>		-	-	-
<b>3. Non-current liabilities</b>				
a) Long term borrowings	VIII	217.52	-	0.25
b) Deferred Tax Liabilities ( Net)		0.52	-	-
c) Long Term Provisions		1.72	-	-
<b>Total (3)</b>		<b>219.76</b>	-	<b>0.25</b>
<b>4. Current liabilities</b>				
a) Short Term Borrowings	IX	193.59	-	-
b) Trade Payables	X			
- total outstanding dues of micro enterprises and small enterprises		105.10	-	-
- total outstanding dues of creditors other than micro enterprises and small enterprises		114.64	64.41	46.39
c) Other Current Liabilities	XI	49.58	17.54	4.51
d) Short-term provisions	XII	45.18	11.78	1.16
<b>Total (4)</b>		<b>508.09</b>	<b>93.73</b>	<b>52.06</b>
<b>TOTAL - (1)+(2)+(3)+(4)</b>		<b>927.69</b>	<b>132.38</b>	<b>55.16</b>
<b>ASSETS</b>				
<b>1. Non - Current Assets</b>				
a) Property, Plant & Equipment and Intangible Assets				
i.) Property, Plant & Equipment	XIII	23.73	0.24	-
ii) Intangible Assets		17.32	-	-
b) Deferred Tax Assets		-	-	-
c) Other Non-Current Assets	XIV	28.95	2.04	0.20
<b>Total (1)</b>		<b>70.00</b>	<b>2.28</b>	<b>0.20</b>
<b>2. Current Assets</b>				
a) Inventories	XV	118.25	45.00	11.12
b) Trade Receivables	XVI	709.64	64.71	30.19
c) Cash and Bank Balances	XVII	15.60	14.79	11.57
d) Short-term loans and advances	XVIII	4.62	2.10	1.03
e) Other Current Assets	XIX	9.58	3.50	1.05
<b>Total (2)</b>		<b>857.69</b>	<b>130.10</b>	<b>54.96</b>
<b>TOTAL - (1)+(2)</b>		<b>927.69</b>	<b>132.38</b>	<b>55.16</b>

**Annexure II**  
**STATEMENT OF PROFIT AND LOSS, AS RESTATED**

(Rs. in lakhs)

Particulars	Annexure No	Financial Year Ended March		
		2022	2021	2020
<b>INCOME</b>				
Revenue from Operations	XX	805.96	294.80	56.81
Other Income	XXI	1.59	0.43	0.02
<b>Total Income</b>		<b>807.55</b>	<b>295.23</b>	<b>56.83</b>
<b>EXPENSES:</b>				
Cost of material consumed	XXII	569.39	179.41	27.09
Trading Goods Purchases		-	28.13	26.00
Changes in Inventories	XXIII	(73.08)	(25.77)	(5.14)
Employee Benefit Expenses	XXIV	103.21	47.22	0.84
Financial Cost	XXV	15.62	-	-
Depreciation & Amortisation cost	XXVI	6.60	0.03	-
Other Expenses		69.21	19.79	3.73
<b>Total expenses</b>		<b>690.95</b>	<b>248.81</b>	<b>52.52</b>
<b>Exceptional and prior period items</b>		-	-	
<b>Net Profit / (Loss) before Tax</b>		<b>116.60</b>	<b>46.42</b>	<b>4.31</b>
<b>Less: Provision for Tax</b>				
(a) Current Tax		31.66	10.62	1.16
(b) Prior Period Tax		3.48	-	
(c) Deferred Tax		0.52	0.00	-
<b>Total</b>		<b>35.66</b>	<b>10.62</b>	<b>1.16</b>
<b>Net Profit / ( Loss ) for the period after tax but before extra-ordinary items</b>		<b>80.94</b>	<b>35.80</b>	<b>3.15</b>
Extraordinary Items		-	-	-
<b>Net Profit / ( Loss ) for the period after tax and after extra ordinary items available for appropriation</b>		<b>80.94</b>	<b>35.80</b>	<b>3.15</b>

**Annexure III**  
**CASH FLOW STATEMENT, AS RESTATED**

(Rs. in lakhs)

Particulars	Financial Year Ended March		
	2022	2021	2020
<b>Cash Flow From Operating Activities</b>			
Net Profit Before Tax	116.60	46.42	4.31
<b>Adjustments for :</b>			
Depreciation/Amortisation	6.60	0.03	-
Income From Other Sources	(1.59)	(0.43)	-
Finance cost	15.62	-	-
<b>Operating Profit Before Working Capital Adjustment</b>	<b>137.23</b>	<b>46.02</b>	<b>4.31</b>
<b>Adjustment for Changes in Working Capital</b>			
Trade and other payable	155.33	18.02	46.39
Inventories	(73.25)	(33.88)	(11.12)
Other Current Liabilities	32.04	13.03	4.51
Provisions	15.24	-	-
Trade and other Receivables	(644.93)	(34.52)	(30.19)
Other Non-Current assets	(26.91)	(1.84)	(0.20)
Short Term Loans & Advances	(2.51)	(1.07)	(1.03)
Other Current Assets	(4.91)	(1.83)	(1.05)
<b>Cash Flow Generated from Operations</b>	<b>(412.67)</b>	<b>3.93</b>	<b>11.62</b>
Taxes Paid	16.43	0.62	
<b>Net Cash flow from Operating activities (A)</b>	<b>(429.10)</b>	<b>3.31</b>	<b>11.62</b>
<b>Cash Flow From Investing Activities</b>			
(Purchase)/Sale of Fixed Assets	(47.42)	(0.27)	-
Changes in Capital WIP	-	-	-
Interest Received	1.59	0.43	-
<b>Net Cash Flow from Investing Activities ( B)</b>	<b>(45.83)</b>	<b>0.16</b>	<b>-</b>
<b>Cash Flow From Financing Activities</b>			
Proceeds from Share Capital + Securities Premium	80.25	-	5.00
Proceeds from/ ( Repayment of ) Borrowing	411.11	(0.25)	0.25
Finance cost	(15.62)	-	-
IPO Expenses	-	-	(5.30)
<b>Net Cash Flow From Financing Activities (C)</b>	<b>475.74</b>	<b>(0.25)</b>	<b>(0.05)</b>
Net Increase/ ( Decrease) in Cash and Cash Equivalents ( A + B + C )	0.81	3.22	11.57
Cash & Cash equivalent at the beginning of the year	14.79	11.57	-
<b>Cash &amp; Cash Equivalent at the end of the year</b>	<b>15.60</b>	<b>14.79</b>	<b>11.57</b>

Cash & Bank Balances comprises of:

(Rs. in lakhs)

Particulars	Financial Year Ended		
	2022	2021	2020
Cash-in-Hand	0.19	0.24	0.14
Balance with Banks	0.95	2.56	11.18
Balance in FD	14.46	11.99	0.25
Fixed deposit for Performance guarantee and Bank guarantee	-	-	-
<b>Total</b>	<b>15.60</b>	<b>14.79</b>	<b>11.57</b>



## GENERAL INFORMATION

Our Company was incorporated as EP Biocomposites Limited on January 17, 2020 under the Companies Act, 2013 with the Registrar of Companies, Goa bearing Registration number 014240. Further, pursuant to Business Takeover Agreement dated August 31, 2021, our Company acquired the business of M/s. OM Ventures, a proprietorship concern of one of our Promoter Leena Kamat. The Corporate Identification Number of our Company is U28900GA2020PLC014240. For further details pertaining to the change of name of our Company and the change in Registered Office, please refer the chapter “*History and Certain Corporate Matters*” on page no. 98 of this Prospectus.

### BRIEF COMPANY AND ISSUE INFORMATION

<b>Registered Office</b>	<b>EP BIOCOMPOSITES LIMITED</b> <b>Registered Office:</b> C/O OM Ventures, Shed No D-2/12, Bicholim Industrial Estate, Bicholim, Goa - 403504 <b>Tel No.:</b> +91-832-2431081/+91-9158005202 <b>Email ID:</b> info@epkamatgroup.com <b>Website:</b> www.epbiocomposites.com/
<b>Corporate Office</b>	1 <sup>st</sup> Floor, B.R. Commercial Centre, Opp. Parade Ground, Campal, Panaji, Goa-403001 <b>Tel. No:</b> +91-832-2431081/+91-9158005202
<b>Date of Incorporation</b>	January 17, 2020
<b>Company Registration Number</b>	014240
<b>Company Identification Number</b>	U28900GA2020PLC014240
<b>Address of the Registrar of Companies</b>	<b>Address:</b> Company Law Bhawan, EDC Complex, Plot No.21, Poatto Panaji, Goa - 403001 <b>Tel No:</b> -0832-2438617, 2438618 <b>Fax No:</b> 0832-2438617
<b>Issue Programme</b>	<b>Issue Opens on:</b> August 29, 2022 <b>Issue Closes on:</b> September 05, 2022
<b>Designated Stock Exchange</b>	BSE Limited

### Board of Directors

As on the date of this Prospectus, the Board of Directors of our Company comprises of the following:

Name	Designation	DIN	Residential Address
Rajkumar Kamat	Managing Director	01157652	H.No. 323, Sneh, Vodlem Bhat, Taleigao, Caranzalem, Goa- 403002
Shreyas Nadkarni	Executive Director	09396530	C-27, Sunil Apartments, Kastur Park, Shimpoli Road, Borivali (West), Mumbai, Maharashtra-400092
Leena Kamat	Non-Executive Director	02607730	H.No. 323, Sneh, Vodlem Bhat, Taleigao, Caranzalem, Goa- 403002
Nitin Kunkolienker	Non- Executive Independent Director	00005211	Plot No. 25, Sagar society- Donapaula, Caranzalem S.O North Goa- 403002
Dinesh Shenoy	Non- Executive Independent Director	08699459	61, Shantaae Par waddo, Bardez Assonora, Assonora North Goa- 403503.

For further details pertaining to the educational qualification and experience of our Directors, for details please refer to the chapter titled “*Our Management*” beginning on page no.101 of this Prospectus.

### CHIEF FINANCIAL OFFICER

#### Nilam Naresh Kadkade

**Address:** C/O OM Ventures, Shed No D-2/12, Bicholim Industrial Estate, Bicholim, Goa - 403504  
**Tel. No:** +91-832-2431081/91-9158005202  
**Email:** info@epkamatgroup.com

## COMPANY SECRETARY AND COMPLIANCE OFFICER

### Mohammad Faiyazul Haq

**Address:** C/O OM Ventures, Shed No D-2/12,  
Bicholim Industrial Estate, Bicholim, Goa – 403504  
**Tel. No:** +91-832-2431081/91-9158005202  
**Email:** [info@epkamatgroup.com](mailto:info@epkamatgroup.com)

### Investor Grievances

Investors may contact the Company Secretary and Compliance Officer and /or the Registrar to the Issue and/or Lead Manager in case of any pre-Issue or post-Issue related problems, such as non-receipt of letters of Allotment, non-credit of Allotted Equity Shares in the respective beneficiary account and non-receipt of funds by electronic mode.

All grievances may be addressed to the Registrar to the Issue with a copy to the relevant Designated Intermediary with whom the Application Form was submitted, giving full details such as name of the sole or First Applicant, Application Form number, Applicant's DP ID, Client ID, PAN, address of Applicant, number of Equity Shares applied for, ASBA Account number in which the amount equivalent to the Application Amount was blocked or the UPI ID (for Retail Individual Investors who make the payment of Application Amount through the UPI Mechanism), date of Application Form and the name and address of the relevant Designated Intermediary where the Application was submitted. Further, the Applicant shall enclose the Acknowledgment Slip or the application number from the Designated Intermediary in addition to the documents or information mentioned hereinabove. All grievances relating to Applicants submitted through Registered Brokers may be addressed to the Stock Exchanges with a copy to the Registrar to the Issue

In terms of SEBI circular no. SEBI/HO/CFD/DIL2/CIR/P/2018/22, dated February 15, 2018, any ASBA Applicant whose Application has not been considered for Allotment, due to failure on the part of any SCSB, shall have the option to seek redressal of the same by the concerned SCSB within three months of the date of listing of the Equity Shares. SCSBs are required to resolve these complaints within 15 days, failing which the concerned SCSB would have to pay interest at the rate of 15% per annum for any delay beyond this period of 15 days.

## DETAILS OF KEY INTERMEDIARIES PERTAINING TO THIS ISSUE AND OUR COMPANY

### LEAD MANAGER



#### ARYAMAN FINANCIAL SERVICES LIMITED

60, Khatau Building, Ground Floor  
Alkesh Dinesh Modi Marg  
Opp. P. J. Towers (BSE Building),  
Fort, Mumbai – 400 001  
**Tel No.:** +91 – 22 – 6216 6999

**Email:** [ipo@afsl.co.in](mailto:ipo@afsl.co.in)

**For Investor Grievances:** [feedback@afsl.co.in](mailto:feedback@afsl.co.in)

**Website:** [www.afsl.co.in](http://www.afsl.co.in)

**Contact Person:** Vatsal Ganatra

**SEBI Registration No.:** INM000011344

### REGISTRAR TO THE ISSUE



#### BIGSHARE SERVICES PRIVATE LIMITED

Office No. S6-2, 6th Floor, Pinnacle Business Park,  
Mahakali Caves Road, Next to Ahura Centre. Andheri  
(East), Mumbai – 400 093

**Tel. No.:** +91 22 6263 8200

**Email:** [ipo@bigshareonline.com](mailto:ipo@bigshareonline.com)

**Website:** [www.bigshareonline.com](http://www.bigshareonline.com)

**Investor Grievance Email:** [investor@bigshareonline.com](mailto:investor@bigshareonline.com)

**Contact Person:** Babu Rapheal

**SEBI Registration No.:** INR000001385

## LEGAL COUNSEL TO THE ISSUE

### Abdus Samee Abdul Qadir Maniyar (A. A.Maniyar) (Advocate)

Office No. 2-A, Ground Floor, Ali Chambers

Tamarind Street, Fort, Mumbai 400 001

**Tel No.:** +91 - 22 - 2265 5505

**Email:** advaamaniyar@gmail.com

**Contact Person:** Sayyed Allahnaksh

## STATUTORY AUDITOR / PEER REVIEW AUDITOR

### M/s. S.P. Bhandare & Associates, Chartered Accountants

3/UG-4, Models Residency, St. Inez, Panaji, Goa- 403001

**Tel:** +91- (832) 2221464

**Email:** [sandip.bhandare@gmail.com](mailto:sandip.bhandare@gmail.com)

**Contact Person:** CA Sandip P. Bhandare

**Membership No.:** 035615

**Firm Registration No.:** 101157W

**Peer Review No:** 011350

## CHANGES IN THE AUDITORS

Except as disclosed below, there has been no change in the statutory auditors during the three years immediately preceding the date of this Prospectus:

Sr. No.	Date of Change	From	To	Reason for change
1.	August 17, 2021	<b>M/s. Gupta Agarwal &amp; Associates., Chartered Accountants</b> 23, Gangadhar Babu Lane, Imax Lohia Square, 3 <sup>rd</sup> Floor, Room No. 3A, Kolkata-700 012 <b>Tel:</b> + 91 – 8232088288 <b>Email:</b> <a href="mailto:guptaagarwal.associate@gmail.com">guptaagarwal.associate@gmail.com</a> <b>Contact Person:</b> Jay Shanker Gupta <b>Membership No.:</b> 059535 <b>Firm Registration No.:</b> 329001E <b>Peer Review No:</b> 013306	<b>M/s. S.P. Bhandare &amp; Associates, Chartered Accountants</b> 3/UG-4, Models Residency, St. Inez, Panaji, Goa- 403001 <b>Tel No.:</b> +91- (832) 2221464 <b>Email:</b> <a href="mailto:sandip.bhandare@gmail.com">sandip.bhandare@gmail.com</a> <b>Contact Person:</b> Sandip P. Bhandare <b>Membership No.:</b> 035615 <b>Firm Registration No.:</b> 101157W <b>Peer Review No:</b> 011350	Casual Vacancy

## BANKERS TO OUR COMPANY



### CANARA BANK

18<sup>th</sup> June Road, Ground Floor, Mathiaz Plaza, Panaji Goa- 403001

**Contact Person:** Amitesh Kumar

**Tel no. :** 0832-2420646

**Email Id:** [cb0308@canarabank.co](mailto:cb0308@canarabank.co)

**Website:** <https://www.canarabank.com>

## BANKER(S) TO THE ISSUE / REFUND BANK / SPONSOR BANK



### AXIS BANK LIMITED

**Address:** Florence CHS, Ground Floor, Nehru Road, Vakola, Santacruz, Mumbai 400055.

**Contact Person:** Sitaram Pawar

**Tel no. :** +91-7387012441

**Email Id:** [Vakola.branchhead@axisbank.com](mailto:Vakola.branchhead@axisbank.com)

**Website:** <https://www.axisbank.com>

## **SELF-CERTIFIED SYNDICATE BANKS**

The list of banks that have been notified by SEBI to act as the SCSBs (i) in relation to the ASBA (other than through UPI Mechanism) is provided on the website of SEBI at <https://www.sebi.gov.in/sebiweb/other/OtherAction.do?doRecognisedFpi=yes&intmId=34> or <https://www.sebi.gov.in/sebiweb/other/OtherAction.do?doRecognisedFpi=yes&intmId=35>, as applicable or such other website as updated from time to time, and (ii) in relation to ASBA (through UPI Mechanism), a list of which is available on the website of SEBI at <https://sebi.gov.in/sebiweb/other/OtherAction.do?doRecognisedFpi=yes&intmId=40> or such other website as updated from time to time. For a list of branches of the SCSBs named by the respective SCSBs to receive the ASBA Forms from the Designated Intermediaries, refer to the above-mentioned link or any other such website as may be prescribed by SEBI from time to time.

## **INVESTORS BANKS OR ISSUER BANKS FOR UPI**

The list of Self Certified Syndicate Banks that have been notified by SEBI to act as Investors Bank or Issuer Bank for UPI mechanism are provide on the website of SEBI on <https://www.sebi.gov.in/sebiweb/other/OtherAction.do?doRecognisedFpi=yes&intmId=40>. For details on Designated Branches of SCSBs collecting the Bid Cum Application Forms, please refer to the above mentioned SEBI link.

## **REGISTERED BROKERS**

The list of the Registered Brokers eligible to accept ASBA forms, including details such as postal address, telephone number and e-mail address, is provided on the website of SEBI ([www.sebi.gov.in](http://www.sebi.gov.in)) at <https://www.sebi.gov.in/sebiweb/other/OtherAction.do?doRecognised=yes>, respectively, as updated from time to time.

## **REGISTRAR AND SHARE TRANSFER AGENTS**

The list of the RTAs eligible to accept ASBA Forms at the Designated RTA Locations, including details such as address, telephone number and e-mail address, is provided on the websites of SEBI ([www.sebi.gov.in](http://www.sebi.gov.in)) at <https://www.sebi.gov.in/sebiweb/other/OtherAction.do?doRecognised=yes>, respectively, as updated from time to time.

## **COLLECTING DEPOSITORY PARTICIPANTS**

The list of the CDPs eligible to accept ASBA Forms at the Designated CDP Locations, including details such as name and contact details, is provided on the website of SEBI ([www.sebi.gov.in](http://www.sebi.gov.in)) at <https://www.sebi.gov.in/sebiweb/other/OtherAction.do?doRecognised=yes>, respectively, as updated from time to time.

## **INTER SE ALLOCATION OF RESPONSIBILITIES FOR THE ISSUE**

Aryaman Financial Services Limited (AFSL) is the sole Lead Manager (LM) to the issue and all the responsibilities relating to co-ordination and other activities in relation to the Issue shall be performed by them.

## **MONITORING AGENCY**

Since the proceeds from the Fresh Issue does not exceed ₹ 10,000 Lakhs in terms of Regulation 262 (1) of the SEBI ICDR Regulations, our Company is not required to appoint a monitoring agency for the purposes of this Issue. However, as per Section 177 of the Companies Act, 2013, the Audit Committee of our Company, would be monitoring the utilization of the proceeds of the Issue.

## **APPRAISING AUTHORITY**

The objects of the Issue and deployment of funds are not appraised by any independent agency/ bank/ financial institution.

## **CREDIT RATING**

As the Issue is of Equity Shares, the appointment of a credit rating agency is not required.

## IPO GRADING

Since the Issue is being made in terms of Chapter IX of the SEBI (ICDR) Regulations there is no requirement of appointing an IPO Grading agency.

## GREEN SHOE OPTION

No green shoe option is applicable for the Issue.

## TRUSTEES

As this is an Issue of Equity Shares, the appointment of trustees is not required.

## EXPERT OPINION

Except as stated below, our Company has not obtained any expert opinions:

Our Company has received written consent from the Statutory Auditor namely, M/s. S.P. Bhandare & Associates, Chartered Accountants to include their name as required under Section 26(1)(a)(v) of the Companies Act, 2013 in this Prospectus and as “Expert” as defined under section 2(38) of the Companies Act, 2013 in respect to their Report on Restated Financial Statements dated June 06, 2022 and Report on Statement of Tax Benefits dated June 06, 2022 and issued by them, included in this Prospectus and such consent has not been withdrawn as on the date of this Prospectus.

However, the term “expert” shall not be construed to mean an “expert” as defined under the U.S. Securities Act.

## FILING OF ISSUE DOCUMENT

The Prospectus will not be filed with SEBI, nor will SEBI issue any observation on the Issue Document in terms of Regulation 246 (2) of SEBI ICDR Regulations. However, pursuant to sub regulation (5) of Regulation 246 of the SEBI ICDR Regulations, the copy of Prospectus shall be furnished to the Board in a soft copy.

Pursuant to SEBI Circular Number SEBI/HO/CFD/DIL1/CIR/P/2018/011 dated January 19, 2018, a copy of the Prospectus has been filed online through SEBI Intermediary Portal at <https://siportal.sebi.gov.in>. A copy of the Prospectus along with the documents required has been filed under Section 26 of the Companies Act, 2013 will be delivered to the Registrar of Company, Goa situated at Company Law Bhawan, EDC Complex, Plot No.21, Poatto Panaji, Goa – 403001

## ISSUE PROGRAMME

Event	Dates
Issue Opening Date	August 29, 2022
Issue Closing Date	September 05, 2022
Finalization of Basis of Allotment with the Designated Stock Exchange	September 08, 2022
Initiation of Allotment / Refunds / Unblocking of Funds	September 09, 2022
Credit of Equity Shares to demat accounts of allottees	September 12, 2022
Commencement of trading of Equity Shares on the Stock Exchange	September 13, 2022

The above timetable is indicative and does not constitute any obligation on our Company or the Lead Manager. Whilst our Company shall ensure that all steps for the completion of the necessary formalities for the listing and the commencement of trading of the Equity Shares on the Stock Exchange are taken within 6 Working Days of the Issue Closing Date, the timetable may change due to various factors, such as extension of the Issue Period by our Company, or any delays in receiving the final listing and trading approval from the Stock Exchange. The Commencement of trading of the Equity Shares will be entirely at the discretion of the Stock Exchange and in accordance with the applicable laws.

Applications and any revision to the same shall be accepted only between **10.00 a.m. and 5.00 p.m.** (IST) during the Issue Period (except for the Issue Closing Date). On the Issue Closing Date, the Applications and any revision to the same shall be accepted between **10.00 a.m. and 3.00 p.m.** (IST) or such extended time as permitted by the Stock Exchanges, in case of Applications by Retail Individual Applicants after taking into account the total number of applications received up to the closure of timings and reported by the Lead Manager to the Stock Exchanges. It is

clarified that Applications not uploaded on the electronic system would be rejected. Applications will be accepted only on Working Days, i.e., Monday to Friday (excluding any public holiday).

Due to limitation of time available for uploading the Applications on the Issue Closing Date, the Applicants are advised to submit their Applications one day prior to the Issue Closing Date and, in any case, no later than 3.00 p.m. (IST) on the Issue Closing Date. All times mentioned in this Prospectus are Indian Standard Times. Applicants are cautioned that in the event a large number of Applications are received on the Issue Closing Date, as is typically experienced in public offerings, some Applications may not get uploaded due to lack of sufficient time. Such Applications that cannot be uploaded will not be considered for allocation under the Issue. Applications will be accepted only on Business Days. Neither our Company, nor the Lead Manager is liable for any failure in uploading the Applications due to faults in any software/hardware system or otherwise.

In accordance with the SEBI Regulations, QIBs and Non-Institutional Applicants are not allowed to withdraw or lower the size of their Applications (in terms of the quantity of the Equity Shares or the Applications Amount) at any stage. Retail Individual Applicants can revise or withdraw their Applications prior to the Issue Closing Date. Except Allocation to Retail Individual Investors, Allocation in the Issue will be on a proportionate basis.

In case of discrepancy in the data entered in the electronic book vis-à-vis the data contained in the physical or the electronic Application Form, for a particular Applicant, the details as per the file received from the Stock Exchange may be taken as the final data for the purpose of Allotment. In case of discrepancy in the data entered in the electronic book vis-à-vis the data contained in the physical or electronic Application Form, for a particular ASBA Applicant, the Registrar to the Issue shall ask the relevant SCSB or the member of the Syndicate for rectified data.

#### UNDERWRITING AGREEMENT

This Issue is 100% Underwritten. The Underwriting agreement is dated March 09, 2022 and addendum dated June 02, 2022. Pursuant to the terms of the Underwriting Agreement, the obligations of the Underwriters are several and are subject to certain conditions specified therein. The Underwriters have indicated their intention to underwrite the following number of specified securities being offered through this Issue:

Details of the Underwriter	No. of Shares Underwritten	Amount Underwritten	% of total Issue size underwritten
<b>Aryaman Financial Services Limited</b> 60, Khatau Building, Gr. Floor, Alkesh Dinesh Modi Marg, Opp. P. J. Tower (BSE Bldg.), Fort, Mumbai – 400 001 <b>Tel. No.:</b> +91 – 22 – 6216 6999 <b>Email:</b> ipo@afsl.co.in	4,76,000	599.76 Lakhs	94.44%
<b>Aryaman Capital Markets Limited</b> 60, Khatau Building, Gr. Floor, Alkesh Dinesh Modi Marg, Opp. P. J. Tower (BSE Bldg.), Fort, Mumbai – 400 001 <b>Tel. No.:</b> +91 – 22 – 6216 6999 <b>Email:</b> aryacapm@gmail.com	28,000	35.28 lakhs	5.56%
<b>Total</b>	<b>5,04,000</b>	<b>635.04 lakhs</b>	<b>100.00%</b>

As per Regulation 260(2) of SEBI (ICDR) Regulations, 2018, the Lead Manager has agreed to underwrite to a minimum extent of 15% of the Issue out of its own account. In the opinion of the Board of Directors (based on certificate given by the Underwriters), the resources of the above mentioned Underwriters are sufficient to enable them to discharge their respective underwriting obligations in full. The above mentioned Underwriters are registered with SEBI under Section 12(1) of the SEBI Act or registered as broker with the Stock Exchange.

#### WITHDRAWAL OF THE ISSUE

Our Company in consultation with the Lead Manager, reserves the right not to proceed with the Issue at any time after the Issue Opening Date but before the Board meeting for Allotment. In such an event our Company would Issue a public notice in the newspapers, in which the pre- Issue advertisements were published, within two days of the Issue Closing Date or such other time as may be prescribed by SEBI, providing reasons for not proceeding with the Issue.



The Lead Manager, through the Registrar to the Issue, shall notify the SCsBs to unblock the bank accounts of the ASBA Applicants within one day of receipt of such notification. Our Company shall also promptly inform the Stock Exchange on which the Equity Shares were proposed to be listed. Notwithstanding the foregoing, the Issue is also subject to obtaining the final listing and trading approvals of the Stock Exchange, which our Company shall apply for after Allotment. If our Company withdraws the Issue after the Issue Closing Date and thereafter determines that it will proceed with an IPO, our Company shall be required to file a fresh Draft Prospectus.

## MARKET MAKER



### ARYAMAN CAPITAL MARKETS LIMITED

60, Khatau Building, Gr. Floor,  
Alkesh Dinesh Modi Marg,  
Opp. P. J. Tower (BSE Bldg.),  
Fort, Mumbai – 400 001

**Tel. No.:** +91 – 22 – 6216 6999

**Email:** aryacapm@gmail.com

**Contact Person:** Mr. Harshad Dhanawade

**SEBI Registration No.:** SMEMM0651421122012

### Details of the Market Making Arrangement for this Issue

Our Company and the Lead Manager, have entered into an agreement dated March 09, 2022 and addendum dated June 02, 2022, a Market Maker registered with SME Platform of BSE Limited in order to fulfil the obligations of Market Making

The Market Maker shall fulfil the applicable obligations and conditions as specified in the SEBI (ICDR) Regulations, and its amendments from time to time and the circulars issued by the BSE and SEBI regarding this matter from time to time.

Following is a summary of the key details pertaining to the Market Making arrangement:

1. The Market Maker shall be required to provide a 2-way quote for 75% of the time in a day. The same shall be monitored by the Stock Exchange. Further, the Market Maker shall inform the exchange in advance for each and every black out period when the quotes are not being offered by the Market Maker.
2. The minimum depth of the quote shall be ₹1, 00,000. However, the investors with holdings of value less than ₹ 1,00,000 shall be allowed to Issue their holding to the Market Maker in that scrip provided that he sells his entire holding in that scrip in one lot along with a declaration to the effect to the selling broker.
3. The Inventory Management and Buying/Selling Quotations and its mechanism shall be as per the relevant circulars issued by SEBI and SME Platform of BSE Limited from time to time.
4. Execution of the order at the quoted price and quantity must be guaranteed by the Market Maker, for the quotes given by him.
5. There would not be more than five Market Makers for a script at any point of time and the Market Makers may compete with other Market Makers for better quotes to the investors.
6. The shares of the Company will be traded in continuous trading session from the time and day the company gets listed on SME Platform of BSE Limited and Market Maker will remain present as per the guidelines mentioned under BSE and SEBI circulars.
7. There will be special circumstances under which the Market Maker may be allowed to withdraw temporarily/fully from the market – for instance due to system problems or any other problems. All controllable reasons require prior approval from the Exchange, while force-majeure will be applicable for non-controllable reasons. The decision of the Exchange for deciding controllable and non-controllable reasons would be final.
8. The price band shall be 20% and the Market Maker Spread (difference between the sell and the buy quote) shall be within 10% or as intimated by Exchange from time to time.

9. The Market Maker shall have the right to terminate the said arrangement by giving a three months' notice or on mutually acceptable terms to the Lead Manager, who shall then be responsible to appoint a replacement Market Maker.

In case of termination of the above mentioned Market Making Agreement prior to the completion of the compulsory Market Making period, it shall be the responsibility of the Lead Manager to arrange for another Market Maker in replacement during the term of the notice period being served by the Market Maker but prior to the date of releasing the existing Market Maker from its duties in order to ensure compliance with the requirements of regulation 261 of the SEBI (ICDR) Regulations, 2018. Further the Company and the Lead Manager reserve the right to appoint other Market Makers either as a replacement of the current Market Maker or as an additional Market Maker subject to the total number of Designated Market Makers does not exceed five or as specified by the relevant laws and regulations applicable at that particular point of time.

10. **Risk containment measures and monitoring for Market Maker:** SME Platform of BSE Limited will have all margins which are applicable on the BSE Main Board viz., Mark-to-Market, Value-At-Risk (VAR) Margin, Extreme Loss Margin, Special Margins and Base Minimum Capital etc. BSE can impose any other margins as deemed necessary from time-to-time.
11. **Punitive Action in case of default by Market Maker:** SME Platform of BSE Limited will monitor the obligations on a real-time basis and punitive action will be initiated for any exceptions and/or non-compliances. Penalties / fines may be imposed by the Exchange on the Market Maker, in case he is not able to provide the desired liquidity in a particular security as per the specified guidelines. These penalties / fines will be set by the Exchange from time to time. The Exchange will impose a penalty on the Market Maker in case he is not present in the market (offering two way quotes) for at least 75% of the time. The nature of the penalty will be monetary as well as suspension in market making activities / trading membership. The Department of Surveillance and Supervision of the Exchange would decide and publish the penalties / fines / suspension for any type of misconduct/ manipulation/ other irregularities by the Market Maker from time to time.
12. Price Band and Spreads: SEBI Circular bearing reference no: CIR/MRD/DP/ 02/2012 dated January 20, 2012, has laid down that for Issue size up to ₹ 250 Crores, the applicable price bands for the first day shall be:

- In case equilibrium price is discovered in the Call Auction, the price band in the normal trading session shall be 5% of the equilibrium price.
- In case equilibrium price is not discovered in the Call Auction, the price band in the normal trading session shall be 5% of the Issue price.

Additionally, the trading shall take place in TFT segment for first 10 days from commencement of trading. The price band shall be 20% and the Market Maker Spread (difference between the sell and the buy quote) shall be within 10% or as intimated by Exchange from time to time.

The following spread will be applicable on the SME Exchange Platform:

Sr. No.	Market Price Slab (in M)	Proposed spread (in % to sale price)
1.	Up to 50	9
2.	50 to 75	8
3.	75 to 100	7
4.	Above 100	6

13. Pursuant to SEBI Circular number CIR/MRD/DSA/31/2012 dated November 27, 2012, limits on the upper side for Markets Makers during market making process has been made applicable, based on the issue size and as follows:

<b>Issue Size</b>	<b>Buy quote exemption threshold (including mandatory initial inventory of 5% of the Issue Size)</b>	<b>Re-Entry threshold for buy quote (including mandatory initial inventory of 5% of the Issue Size)</b>
Up to ₹ 20 Crores	25%	24%
₹ 20 Crores to ₹ 50 Crores	20%	19%
₹ 50 Crores to ₹ 80 Crores	15%	14%
Above ₹ 80 Crores	12%	11%

**All the above mentioned conditions and systems regarding the Market Making Arrangement are subject to change based on changes or additional regulations and guidelines from SEBI and Stock Exchange from time to time.**

**On the first day of listing, there will be a pre-open session (call auction) and there after trading will happen as per the equity market hours. The circuits will apply from the first day of the listing on the discovered price during the pre-open call auction. The securities of the Company will be placed in SPOS and would remain in Trade for Trade settlement for 10 days from the date of listing of Equity Shares on the Stock Exchange.**

## CAPITAL STRUCTURE

The Equity Share capital of our Company, as on the date of this Prospectus and after giving effect to this Issue, is set forth below:

(₹ in lakhs except share data)

Sr. No.	Particulars	Aggregate Value at Face Value	Aggregate Value at Issue Price
<b>A.</b>	<b>Authorized Share Capital</b>		
	20,00,000 Equity Shares of face value of ₹10 each	200.00	-
<b>B.</b>	<b>Issued, Subscribed And Paid-Up Equity Capital before the Issue</b>		
	11,77,500 Equity Shares of face value of ₹10 each	117.75	-
<b>C.</b>	<b>Present Issue in Terms of this Prospectus</b>		
	Issue of 5,04,000 Equity Shares of face value of ₹10 each <sup>(1)</sup>	50.16	635.04
	<b>Which Comprises:</b>		
	28,000 Equity Shares of face value of ₹10 each at a price of ₹ 126 per Equity Share reserved as Market Maker Portion	2.64	35.28
	Net Issue to Public of 4,76,000 Equity Shares of face value of ₹10 each at a price of ₹126 per Equity Share to the Public	47.52	599.76
	<i>Of which<sup>(2)</sup></i>		
	Allocation to Retail Individual Investors of 2,38,000 Equity Shares	23.76	299.88
	Allocation to other than Retail Individual Investors of 2,38,000 Equity Shares	23.76	299.88
<b>D.</b>	<b>Paid-up Equity Capital after the Issue</b>		
	16,81,500 Equity Shares of face value of ₹10 each		168.15
<b>E.</b>	<b>Securities Premium Account</b>		
	Before the Issue		NIL
	After the Issue		584.64

<sup>(1)</sup> The present Issue has been authorized by our Board pursuant to a resolution passed at its meeting held on January 7, 2022 and by our Shareholders pursuant to a Special Resolution passed at the Extra-Ordinary General meeting held on January 10, 2022.

<sup>(2)</sup> Allocation to all categories shall be made on a proportionate basis subject to valid Applications received at or above the Issue Price. Under subscription, if any, in any of the categories, would be allowed to be met with spill-over from any of the other categories or a combination of categories at the discretion of our Company in consultation with the Lead Manager and Designated Stock Exchange. Such inter-se spill over, if any, would be affected in accordance with applicable laws, rules, regulations and guidelines.

Our Company has no outstanding convertible instruments as on the date of this Prospectus.

### CHANGES IN AUTHORIZED SHARE CAPITAL

Since incorporation, the capital structure of our Company has been altered in the following manner:

The initial Authorized Share Capital shares of ₹ 15,00,000 (Fifteen Lakhs) divided into 1,50,000 (One Lakh Fifty Thousand) Equity Shares of ₹ 10 each was increased to ₹ 2,00,00,000 (Two Crores) divided into 20,00,000 (Twenty Lakh) Equity Shares of ₹ 10 each pursuant to Shareholders Resolution passed at the Annual General Meeting held on July 7, 2021.

### NOTES TO THE CAPITAL STRUCTURE

#### 1. Equity Share Capital History of our Company

The following table sets forth details of the history of the Equity Share capital of our Company:

Date of Allotment	No. of Equity Shares allotted	Face Value (₹)	Issue Price (₹)	Nature of Consideration	Nature of Allotment	Cumulative No. of Equity Shares	Cumulative Paid Up Equity Shares Capital (₹)	Cumulative Share Premium (₹)
Upon Incorporation <sup>(1)</sup>	50,000	10	10	Cash	Subscription to MOA	50,000	5,00,000	NIL
September 16, 2021 <sup>(2)</sup>	3,25,000	10	N.A.	Other than Cash	Bonus Allotment	3,75,000	37,50,000	NIL
September 27, 2021 <sup>(3)</sup>	8,02,500	10	10	Cash	Rights Issue	11,77,500	1,17,75,000	NIL

<sup>(1)</sup> Initial Subscription to MoA of 45,000 Equity Shares by Leena Kamat, 2,000 Equity Shares by Rajkumar Kamat, 2,000 Equity Shares by Nimisha Kamat, 250 Equity Shares by Shreyas Nadkarni, 250 Equity Shares by Ashma Kamat, 250 Equity Shares by Dattaram Chimulkar, 250 Equity Shares by Hemant Kalangutkar.

<sup>(2)</sup> Vide resolution dated September 16, 2021, our Company has allotted 3,25,000 Equity Shares as Bonus Issue to Leena Kamat (2,92,500 Equity Share), Rajkumar Kamat (13,000 Equity Shares), Nimisha Kamat (13,000 Equity Shares), Shreyas Nadkarni (1,625 Equity Shares), Ashma Kamat (1,625 Equity Shares), Dattaram Chimulkar (1,625 Equity Shares), and Hemant Kalangutkar (1,625 Equity Shares) in the proportion of 13 Equity Shares for every 2 Equity Share held, by capitalization of Free reserves.

<sup>(3)</sup> Vide resolution dated September 27, 2021, our Company has allotted 8,02,500 Equity Shares as Rights Issue to Leena Kamat (7,54,348 Equity Shares) and Rajkumar Kamat (48,152 Equity shares) by way of Rights Issue in lieu of outstanding unsecured loan.

## 2. Details of Equity Shares issued for consideration other than cash:

Except as set out below we have not issued Equity Shares for consideration other than cash:

Date of Allotment	Number of Equity Shares	Face Value (₹)	Issue Price (₹)	Reasons for Allotment	Benefit accrued to Company
September 16, 2021 <sup>(1)</sup>	3,25,000	10	N.A.	Bonus Issue	Expansion of Capital

<sup>(1)</sup> Vide resolution dated September 16, 2021, our Company has allotted 3,25,000 Equity Shares as Bonus Issue to Leena Kamat (2,92,500 Equity Share), Rajkumar Kamat (13,000 Equity Shares), Nimisha Kamat (13,000 Equity Shares), Shreyas Nadkarni (1,625 Equity Shares), Ashma Kamat (1,625 Equity Shares), Dattaram Chimulkar (1,625 Equity Shares), and Hemant Kalangutkar (1,625 Equity Shares) in the proportion of 13 Equity Shares for every 2 Equity Share held, by capitalization of Free reserves.

3. No shares have been allotted in terms of any scheme approved under sections 230-234 of the Companies Act, 2013.

4. Our Company has not issued any shares pursuant to an Employee Stock Option Scheme.

No shares have been issued at a price lower than the Issue Price within the last one year from the date of the Prospectus except as mentioned under:

Date of Allotment	Name of Allottees	Number of Shares	Reasons for Allotment	Promoter/ Promoter Group
September 16, 2021	Leena Kamat	2,92,500	Bonus Issue	Yes
	Rajkumar Kamat	13,000		Yes
	Nimisha Kamat	13,000		Yes
	Shreyas Nadkarni	1,625		Yes
	Ashma Kamat	1,625		Yes
	Dattaram Chimulkar	1,625		No
	Hemant Kalangutkar	1,625		No

## 5. Shareholding Pattern of our Company

a) The table below presents the current shareholding pattern of our Company as on the date of this Prospectus.

Category (I)	Category of shareholder(II)	Nos. of shareholders (III)	No. of fully paid up equity shares held (IV)	No. of Partly paid-up equity shares held (V)	No. of shares underlying Depository Receipts (VI)	Total nos. shares held (VII) = (IV)+(V)+(VI)	Shareholding as a % of total no. of shares (calculated as per SCRR, 1957) (VIII) As a % of (A+B+C2)	Number of Voting Rights held in each class of securities (IX)				No. of Underlying Outstanding convertible securities (including Warrants) (X)	Shareholding, as a % assuming full convertible securities (as a percentage of diluted share capital) (XI)= (VII)+(X) As a % of (A+B+C2)	Number of Locked in shares (XII)		Number of Shares pledged or otherwise encumbered (XIII)		Number of equity shares held in dematerialized form (XIV)
								No of Voting Rights			Total as a % of (A+B+C)			No (a)	As a % of total Shares held (b)	No (a)	As a % of total Shares held (b)	
								Class-Equity	Class	Total								
A	Promoter & Promoter Group	4	11,65,416	-	-	11,65,416	98.97 %	11,65,416	-	11,65,416	98.97 %	-	-	-	-	-	-	11,65,416
B	Public	3	12,084	-	-	12,084	1.03%	12,084	-	12,084	1.03%	-	-	-	-	-	-	12,084
C	Non Promoter Non Public	-	-	-	-	-	-	-	-	-	-	-	-	-	-	-	-	-
C1	Shares underlying DRs	-	-	-	-	-	-	-	-	-	-	-	-	-	-	-	-	-
C2	Shares held by Employee Trusts	-	-	-	-	-	-	-	-	-	-	-	-	-	-	-	-	-
	<b>Total</b>	<b>7</b>	<b>11,77,500</b>	<b>-</b>	<b>-</b>	<b>11,77,500</b>	<b>100.00%</b>	<b>11,77,500</b>	<b>-</b>	<b>11,77,500</b>	<b>100.00%</b>	<b>-</b>	<b>-</b>	<b>-</b>	<b>-</b>	<b>-</b>	<b>-</b>	<b>11,77,500</b>



- b) Set forth below is a list of Shareholders holding 1% or more of the paid-up Share Capital of our Company as on the date of this Prospectus

Sr. No.	Name of the Shareholder	Number of Equity shares	Percentage of the pre-Issue Equity Share Capital (%)
1.	Leena Kamat	10,91,848	92.73%
2.	Rajkumar Kamat	63,152	5.36%
<b>Total</b>		<b>11,55,000</b>	<b>98.09%</b>

- c) Set forth below is a list of Shareholders holding 1% or more of the paid-up Share Capital of our Company as of two year prior to the date of this Prospectus.

Sr. No.	Name of the Shareholder	Number of Equity shares	Percentage of the pre-Issue Equity Share Capital (%)
1.	Leena Kamat	45,000	90.00%
2.	Rajkumar Kamat	2,000	4.00%
3..	Nimisha Kamat	2,000	4.00%
<b>Total</b>		<b>49,000</b>	<b>98.00%</b>

- d) Set forth below is a list of Shareholders holding 1% or more of the paid-up Share Capital of our Company as of One year prior to the date of this Prospectus.

Sr. No.	Name of the Shareholder	Number of Equity shares	Percentage of the pre-Issue Equity Share Capital (%)
1.	Leena Kamat	45,000	90.00%
2.	Rajkumar Kamat	2,000	4.00%
3..	Nimisha Kamat	2,000	4.00%
<b>Total</b>		<b>49,000</b>	<b>98.00%</b>

- e) Set forth below is a list of Shareholders holding 1% or more of the paid-up Share Capital of our Company, on a fully diluted basis, as of 10 days prior to the date of this Prospectus.

Sr. No.	Name of the Shareholder	Number of Equity shares	Percentage of the pre-Issue Equity Share Capital (%)
1.	Leena Kamat	10,91,848	92.73%
2.	Rajkumar Kamat	63,152	5.36%
3.	Nimisha Kamat	15,000	1.27%
<b>Total</b>		<b>11,70,000</b>	<b>99.36%</b>

- f) Except as stated above, our Company has not made any public issue since its incorporation.

6. Except as disclosed in this Prospectus, our Company does not have any intention or proposal to alter our capital structure within a period of 6 months from the date of opening of the Issue by way of split/ consolidation of the denomination of Equity Shares or further issue of Equity Shares (including issue of securities convertible into exchangeable, directly or indirectly, for our Equity Shares) whether preferential or bonus, rights, further public issue or qualified institutions placement or otherwise. However, our Company may further issue Equity Shares (including issue of securities convertible into Equity Shares) whether preferential or otherwise after the date of the opening of the Issue to finance an acquisition, merger or joint venture or for regulatory compliance or such other scheme of arrangement or any other purpose as the Board may deem fit, if an opportunity of such nature is determined by its Board of Directors to be in the interest of our Company.

## 7. Shareholding of our Promoter

a) Build-up of the shareholding of our Promoter in our Company since incorporation

Date of Allotment / Transfer	Nature of Issue / Transaction	Nature of Consideration	No. of Equity Shares	FV (₹)	Acquisition / Transfer Price	Cumulative No. of shares	% of Pre Issue Equity Share Capital	% of Post Issue Equity Share Capital
<b>Leena Kamat</b>								
Upon Incorporation <sup>(1)</sup>	Subscription to MOA	Cash	45,000	10	10	45,000	3.82%	2.68%
September 16, 2021 <sup>(2)</sup>	Bonus Allotment	Other than Cash	2,92,500	10	N.A	3,37,500	24.84%	17.42%
September 27, 2021 <sup>(3)</sup>	Rights Issue	Cash	7,54,348	10	10	10,91,848	64.06%	44.93%
<b>Rajkumar Kamat</b>								
Upon Incorporation <sup>(1)</sup>	Subscription to MOA	Cash	2000	10	10	2000	0.17%	0.12%
September 16, 2021 <sup>(2)</sup>	Bonus Allotment	Other than Cash	13,000	10	N.A	15,000	1.10%	0.77%
September 27, 2021 <sup>(3)</sup>	Rights Issue	Cash	48,152	10	10	63,152	4.09%	2.86%

### Notes:

- None of the shares belonging to our Promoter have been pledged till date.
- The entire Promoter's shares shall be subject to lock-in from the date of allotment of the equity shares issued through this Prospectus for periods as per applicable Regulations of the SEBI (ICDR) Regulations.
- Our Promoter have confirmed to the Company and the Lead Manager that the Equity Shares held by our Promoter have been financed from their personal funds and no loans or financial assistance from any bank or financial institution has been availed by them for this purpose.
- All the shares held by our Promoter, were fully paid-up on the respective dates of acquisition of such shares.

b) Pre-Issue and Post-Issue Shareholding of our, Promoter and Promoter Group

Category of Promoter	Pre-Issue		Post-Issue	
	No. of Shares	% of Pre-Issue Capital	No. of Shares	% of Post-Issue Capital
<b>1. Promoter</b>				
Leena Kamat	10,91,848	92.73%	10,91,848	65.02%
Rajkumar Kamat	63,152	5.36%	63,152	3.76%
<b>2. Promoter Group (as per defined by Reg. 2(1)(pp) of SEBI ICDR Regulations)</b>				
Nimisha Kamat	5,208	0.71%	5,208	0.31%
Ashma Kamat	5,208	0.71%	5,208	0.31%
<b>Total Promoter &amp; Promoter Group Holding</b>	<b>11,65,416</b>	<b>98.97%</b>	<b>11,65,416</b>	<b>69.40%</b>
<b>Total Paid up Capital</b>	<b>11,77,500</b>	<b>100.00%</b>	<b>16,79,100</b>	<b>100.00%</b>

All Equity Shares held by the Promoter and members of our Promoter Group have been dematerialised as on date of this Prospectus.

8. Our Company has Seven (7) shareholders, as on the date of this Prospectus.

9. We hereby confirm that:

- a) Except as mentioned below, None of the members of the Promoter, Promoter Group, Directors and their immediate relatives have Purchased or sold any Equity shares of our Company within the last six months from the date of the Draft Prospectus:

Sr. No.	Date of Transfer	Name of Transferor	No. of Shares	Name of Transferee
1.	June 03, 2022	Nimisha Kamat	3,333	Ashma Kamat
2.	June 03, 2022	Nimisha Kamat	6,459	Shreyas Dattatray

- b) None of the members of the Promoter Group, Directors and their immediate relatives have financed the purchase by any other person of Equity shares of our Company other than in the normal course of business of the financing entity within the period of six months immediately preceding the date of this Prospectus.

#### 10. Promoter's Contribution and Lock-in details

- a) *Details of Promoter's Contribution locked-in for three (3) years*

Pursuant to the Regulation 236 and 238 of the SEBI (ICDR) Regulations, an aggregate of 20% of the Post-Issue Equity Share Capital held by our Promoter shall be considered as promoter's contribution ("Promoter's Contribution") and locked-in for a period of three years from the date of Allotment. The lock-in of the Promoter's Contribution would be created as per applicable law and procedure and details of the same shall also be provided to the Stock Exchange before listing of the Equity Shares.

The details of the Promoter's Equity Shares proposed to be locked-in for a period of three years are as follows:

Name of the Promoter	Number of shares locked-in <sup>(1)</sup>	As a % of Post Issue Share Capital
Leena Kamat	3,33,000	19.83%
Rajkumar Kamat	12,000	0.71%
<b>Total</b>	<b>3,45,000</b>	<b>20.54%</b>

<sup>(1)</sup>For details on the date of Allotment of the above Equity Shares, the nature of Allotment, face value and the price at which they were acquired, please refer "Notes to Capital Structure" on page no. 48 of this Prospectus.

We confirm that in compliance with Regulation 237 of SEBI ICDR Regulations, the minimum Promoter contribution of 20% as shown above which is subject to lock-in for three years does not consist of:

- Equity Shares acquired during the preceding three years for consideration other than cash and out of revaluation of assets or capitalization of intangible assets or bonus shares out of revaluation reserves or reserves without accrual of cash resources.
- Equity Shares acquired by the Promoter during the preceding one year, at a price lower than the price at which Equity Shares are being issued to public in the Issue.
- The Equity Shares held by the Promoter and offered for minimum 20% Promoter' Contribution is not subject to any pledge.
- Equity Shares for which specific written consent has not been obtained from the shareholders for inclusion of their subscription in the minimum Promoter' Contribution subject to lock-in.

**We further confirm that our Promoter' Contribution of 20% of the Post Issue Equity does not include any contribution from Alternative Investment Funds or FVCI or Scheduled Commercial Banks or Public Financial Institutions or Insurance Companies.**

- a) *Details of share capital locked-in for one (1) year*

- i) Pursuant to Regulation 238 (b) of the SEBI (ICDR) Regulations, in addition to the Promoter's Contribution to be locked-in for a period of 3 years, as specified above, the entire Pre-Issue Equity Share capital will be locked in for a period of one (1) year from the date of Allotment in this Issue.

- ii) Pursuant to Regulation 242 of the SEBI Regulations, the Equity Shares held by our Promoter can be pledged only with banks or financial institutions as collateral security for loans granted by such banks or financial institutions for the purpose of financing one or more of the objects of the Issue and the pledge of shares is one of the terms of sanction of such loan. However, as on date of this Prospectus, none of the Equity Shares held by our Promoter have been pledged to any person, including banks and financial institutions.
  - iii) Pursuant to Regulation 243 of the SEBI (ICDR) Regulations, Equity Shares held by our Promoter, which are locked in as per Regulation 238 of the SEBI (ICDR) Regulations, may be transferred to and amongst our Promoter / Promoter Group or to a new promoter or persons in control of our Company subject to continuation of the lock-in in the hands of the transferees for the remaining period and compliance with Securities and Exchange Board of India (Substantial Acquisition of Shares and Takeover) Regulations, 2011 as applicable.
  - iv) Pursuant to Regulation 243 of the SEBI (ICDR) Regulations, Equity Shares held by shareholders other than our Promoter, which are locked-in as per Regulation 239 of the SEBI (ICDR) Regulations, may be transferred to any other person holding shares, subject to continuation of the lock-in in the hands of the transferees for the remaining period and compliance with Securities and Exchange Board of India (Substantial Acquisition of Shares and Takeover) Regulations, 2011 as applicable.
11. Neither the Company, nor its Promoter, Directors or the Lead Manager have entered into any buyback and/or standby arrangements for purchase of Equity Shares of the Company from any person.
  12. All Equity Shares issued pursuant to the Issue shall be fully paid-up at the time of Allotment and there are no partly paid-up Equity Shares as on the date of this Prospectus. Further, since the entire money in respect of the Issue is being called on application, all the successful Applicants will be issued fully paid-up Equity Shares
  13. As on the date of this Prospectus, the Lead Manager and their respective associates (as defined under the Securities and Exchange Board of India (Merchant Bankers) Regulations, 1992) do not hold any Equity Shares of our Company. The Lead Manager and their affiliates may engage in the transactions with and perform services for our Company in the ordinary course of business or may in the future engage in commercial banking and investment banking transactions with our Company for which they may in the future receive customary compensation.
  14. As on date of this Prospectus, there are no outstanding ESOP's, warrants, options or rights to convert debentures, loans or other instruments convertible into the Equity Shares, nor has the company ever allotted any equity shares pursuant to conversion of ESOP's till date.
  15. None of our Directors or Key Managerial Personnel holds Equity Shares in the Company, except as stated in the chapter titled "*Our Management*" beginning on page no. 101 of this Prospectus.
  16. Investors may note that in case of over-subscription, allotment will be on proportionate basis as detailed under "Basis of Allotment" in the chapter titled "*Issue Procedure*" beginning on page no 179 of this Prospectus. In case of over-subscription in all categories the allocation in the Issue shall be as per the requirements of Regulation 253 (2) of SEBI (ICDR) Regulations, as amended from time to time.
  17. An over-subscription to the extent of 10% of the Issue can be retained for the purpose of rounding off to the nearest integer during finalizing the allotment, subject to minimum allotment, which is the minimum application size in this Issue. Consequently, the actual allotment may go up by a maximum of 10% of the Issue, as a result of which, the post Issue paid up capital after the Issue would also increase by the excess amount of allotment so made. In such an event, the Equity Shares held by the Promoter and subject to lock-in shall be suitably increased; so as to ensure that 20% of the post Issue paid-up capital is locked in.
  18. Subject to valid applications being received at or above the Issue Price, under subscription, if any, in any of the categories, would be allowed to be met with spill-over from any of the other categories or a combination of categories at the discretion of our Company in consultation with the Lead Manager and Designated Stock Exchange. Such inter-se spill over, if any, would be effected in accordance with applicable laws, rules, regulations and guidelines
  19. No payment, direct, indirect in the nature of discount, commission, and allowance, or otherwise shall be made either by us or by our Promoter to the persons who receive allotments, if any, in this Issue.

20. There shall be only one denomination of Equity Shares of our Company unless otherwise permitted by law. Our Company shall comply with disclosure and accounting norms as may be specified by SEBI from time to time.
21. Our Company shall ensure that transactions in the Equity Shares by our Promoter and our Promoter Group between the date of this Prospectus and the Issue Closing Date shall be reported to the Stock Exchange within 24 hours of such transaction.
22. Our Promoter and Promoter Group will not participate in the Issue.
23. Our Company has not re-valued its assets and we do not have any revaluation reserves till date.

## SECTION V – PARTICULARS OF THE ISSUE

### OBJECTS OF THE ISSUE

#### Issue Proceeds & Net Issue Proceeds

The details of the proceeds of the Fresh Issue are set forth in the table below:

(₹ in lakhs)

Sr. No.	Particulars	Amount
1	Gross Proceeds of the Fresh Issue	635.04
2	Issue related Expenses <sup>(1)</sup>	55.00
	<b>Net Proceeds of the Fresh Issue</b>	<b>580.04</b>

<sup>(1)</sup> The Issue related expenses are estimated expenses and subject to change.

#### Net Proceeds from Fresh Issue

The Objects of the Net Proceeds from Fresh Issue is to raise funds for:

- Long term lease deposit for Manufacturing Facility Part Repayment of Loan
- Funding Working Capital Requirement
- General Corporate Purpose

Further, our Company expects that the listing of the Equity Shares will enhance our visibility and our brand image among our existing and potential customers.

The Main Objects clause as set out in the Memorandum of Association enables our Company to undertake its existing activities and the activities for which funds are being raised by the Company through the Present Issue. Further, we confirm that the activities that we have been conducting until now are in accordance with the objects clause of our Memorandum of Association.

#### Proposed Schedule of Implementation and Deployment of the Net Proceeds

The Net Proceeds of the Fresh Issue (“Net Proceeds”) are currently expected to be deployed in accordance with the schedule as stated below:

(₹ in lakhs)

Sr. No.	Object	Amount to be funded from Net Proceeds	Amount to be deployed from Net Proceeds in Fiscal 2023
1.	Long term lease deposit for manufacturing facilities	200.00	200.00
2.	Part Repayment of loan	80.00	80.00
3.	Funding Working Capital Requirement	151.18	151.18
4.	General Corporate Purpose	148.86	148.86
	<b>Total</b>	<b>580.04</b>	<b>580.04</b>

#### Requirement of Funds and Means of Finance

The fund requirements mentioned above are based on the internal management estimates of our Company and have not been verified by the Lead Managers or appraised by any bank, financial institution or any other external agency. They are based on current circumstances of our business and our Company may have to revise its estimates from time to time on account of various factors beyond its control, such as market conditions, competitive environment, costs of commodities and interest or exchange rate fluctuations. Consequently, the fund requirements of our Company are subject to revisions in the future at the discretion of the management. In the event of any shortfall of funds for the activities proposed to be financed out of the Net Proceeds as stated above, our Company may re-allocate the Net Proceeds to the activities where such shortfall has arisen, subject to compliance with applicable laws. Further, in case of a shortfall in the Net Proceeds or cost overruns, our management may explore a range of options including utilising our internal accruals or seeking debt financing.



The entire fund requirements are to be financed from the Net Fresh Issue Proceeds, and there is no requirement to make firm arrangements of finance under Regulation 230(1) (e) of the SEBI ICDR Regulations through verifiable means towards at least 75% of the stated means of finance, excluding the amounts to be raised through the Issue.

For further details on the risks involved in our proposed fund utilization as well as executing our business strategies, please refer the “Risk Factors” on page no. 19 of this Prospectus.

## **DETAILS OF THE FUND REQUIREMENTS**

### **1) Long term lease deposit for Manufacturing Facility**

Our company is incorporated on January 17, 2020, as a public limited company under the provisions of the Companies Act, 2013 with a vision to corporatize our business. Further, pursuant to Business Takeover Agreement dated August 31, 2021, our Company acquired the business of M/s. OM Ventures, a proprietorship firm of one of our Promoter Mrs. Leena Kamat.

Through Business Takeover Agreement our company has taken over only business except real estate in order to save the excess expenses of the company for buying the property and other relevant expenses for transfer of the property. We currently need the Manufacturing facility on a lease hold basis. The land of the said premise is leased by GIDC to M/s OM Ventures. Hence, we have entered into a sub-leasing agreement dated August 13, 2021 for the land as well as building of manufacturing facility, with the owner/lessee of this land and building. We propose to pay an interest free refundable security deposit to the owner/lessee of the manufacturing facility of ₹ 200.00 lakhs, in order to compensate for such land and asset being used by us. Further, by paying a sizable deposit, this allows us to keep our monthly lease costs low and hence helps us manage our cash flows and profitability better. Further it avoids sunk costs towards duties and transfer charges etc also when we move to another property in the future and we get our deposit back upon vacating this premise without the hassle and costs of transfer etc at such stage.

### **2) Part Repayment of Loan**

We have from time to time availed unsecured loan from our Directors. As on March 31, 2022, our Company had total outstanding unsecured loan from Leena Kamat, i.e. Promoter Director amounting to ₹ 92.91 lakhs as confirmed by the Statutory Auditor M/s. S. P. Bhandare & Associates., Chartered Accountants, vide Certificate dated June 06, 2022. This loan carries interest at the rate of 10.50%. M/s. S. P. Bhandare & Associates., Chartered Accountants, has further confirmed that this loan was mainly utilized for working capital needs & other funding requirements of the Company from time to time. For further details, see “Financial Indebtedness” on page no. 151 of this Prospectus.

Our Company proposes to utilize an amount of ₹ 80.00lakhs out of the Net Proceeds towards repayment of the borrowings obtained from Leena Kamat- our Promoter Director.

As of the date of this Prospectus, Our Company has not repaid the above mentioned loan availed from Leena Kamat. However, we may repay the above loan, before we obtain proceeds from the Issue, through other means and source of financing, including bridge loan or other financial arrangements, which then will be repaid from the proceeds of the Issue.

### **3) Funding Working Capital Requirement**

Our business was originally being run as a proprietorship named M/s. OM Ventures. Further, our company has taken over the business with a vision to corporatize our business. A Business Transfer Agreement dated August 31, 2021 has been entered into to give effect to the takeover of the business of M/s. OM Ventures (Proprietor Leena Kamat)

Our Company is into manufacturing and supply of fibre re-inforced polymers (FRP) products such as door shutters, frames, Biodigestor Tanks, Bio toilets besides Bacteria Inoculum & allied products. Our business is working capital intensive and we fund the majority of our working capital requirements in the ordinary course of our business from financing from bank, unsecured loan from directors, financial institutions and internal accruals. As at March 31, 2022, our fund-based sanctioned working capital facilities comprised ₹196 lakhs from banks & other financial institutions. For further information, please refer “Financial Indebtedness” on page no. 151 of this Prospectus.

Our company is incorporated on January 17, 2020, as a public limited company under the provisions of the Companies Act, 2013. Our Company has recently acquired the business of M/s OM ventures (Proprietor Leena Kamat) w.e.f. August 31, 2021 and Fiscal 2022-23 will be the first full year of consolidated businesses into the company. Hence, the historical

audited data is not comparable with the estimated data. The details of our Company's expected working capital requirement as for Fiscal 2022-23 is set out in the table below:

(₹ in lakhs)

Sr. No.	Particulars	Holding Level (days)	For Fiscal 2022-23 (Estimated)
<b>I.</b>	<b>Current Assets:</b>		
1.	Inventories	84	321.00
2.	Trade Receivable	180	690.00
3.	Short Term Loans & Advances	2	8.00
	<b>Total Current Assets (A)</b>		<b>1,019.00</b>
<b>II.</b>	<b>Current Liabilities</b>		
1.	Trade Payables	202	465.00
2.	Other Current Liabilities and Short Term Provisions	43	100.00
	<b>Total Current Liabilities (B)</b>		<b>565.00</b>
<b>III.</b>	<b>Total Working Capital Gap (A – B)</b>		<b>454.00</b>
<b>IV.</b>	<b>Funding Pattern:</b>		
1.	Working Capital Facilities from Banks <sup>(1)</sup>		196.00
2.	Unsecured Loan		106.82
3.	Part of the Net proceeds to be utilized		151.18

<sup>(1)</sup> Our sanctioned working capital facilities as on date of this Prospectus comprised of ₹ 196.00 lakhs from banks and other financial institutions.

<sup>(2)</sup> As on March 31, 2022, we have unsecured loan of ₹224.01 lakhs. We propose to repay ₹ 80.00 lakhs from the Net Issue Proceeds. After such repayment and other repayment, we have assumed our unsecured loan would reduce to ₹ 106.82 lakhs.

#### Justification for holding period levels

Particulars	Details
<b>Current Assets</b>	
Inventories	We procure our raw material required for manufacturing of products in advance based on estimated requirement; hence we have estimated the inventory levels at an average 84 days.
Trade Receivables	We are a manufacturing company of fibre re-inforced polymers (FRP) products such as door shutters, frames, Biodigester Tanks, Bio toilets besides Bacteria Inoculum & allied products. We work with private as well as the government sector for the projects. We get our revenue once project is completed. Our sales collection tenures would differ from project to project. Hence we have estimated the trade receivable levels at an average of 180 days.
<b>Current Liabilities</b>	
Trade Payables	Since our debtor cycles are slow hence we ensure that even our suppliers are managed around similar credit period. Based on the same we have assumed to take creditors payment period to be at around 202 days for FY 2022-23.

#### 4) General Corporate Purpose

Our management will have flexibility to deploy ₹148.86 lakhs, aggregating to 24.36% of the Gross Proceeds towards general corporate purposes, including but not restricted to strategic initiatives, partnerships, joint ventures and acquisitions, branding, marketing, new client referral fees meeting exigencies which our Company may face in the ordinary course of business, to renovate and refurbish certain of our existing Company owned/leased and operated facilities or premises, towards brand promotion activities or any other purposes as may be approved by our Board, subject to compliance with the necessary provisions of the Companies Act.

Our management, in accordance with the policies of the Board, will have flexibility in utilizing any amounts for general corporate purposes under the overall guidance and policies of our Board. The quantum of utilization of funds towards any of the purposes will be determined by the Board, based on the amount actually available under this head and the business requirements of our Company, from time to time.

We confirm that any issue related expenses shall not be considered as a part of General Corporate Purpose. Further, we confirm that in terms of Regulation 230(2) of the SEBI ICDR Regulations, the extent of the Net Proceeds according to this Prospectus, proposed to be used for general corporate purposes, shall not exceed 25% of the amount raised by our Company through the Issue of Equity Shares.

### ISSUE RELATED EXPENSES

The total estimated Issue Expenses are ₹ 55.00 Lakhs, which is 8.66% of the total Issue Size. The details of the Issue Expenses are tabulated below:

Sr. No.	Particulars	Amount (₹ in lakhs)	% of Total Expenses	% of Total Issue size
1	Issue Management fees including fees and payment to other intermediaries such as Legal Advisors, Registrars and other out of pocket expenses.	42.10	76.55%	6.63%
2	Brokerage and selling commission <sup>(1)(2)(3)(4)</sup>	3.18	5.77%	0.50%
3	Printing & Stationery, Distribution, Postage, etc.	1.50	2.73%	0.24%
4	Advertisement and Marketing Expenses	1.50	2.73%	0.24%
5	Stock Exchange Fees, Regulatory and other Expenses	6.72	12.22%	1.06%
	<b>Total</b>	<b>55.00</b>	<b>100.00%</b>	<b>8.66%</b>

- 1) *The SCSBs and other intermediaries will be entitled to a commission of 10 per every valid Application Form submitted to them and uploaded on the electronic system of the Stock Exchange by them.*
- 2) *The SCSBs would be entitled to processing fees of 10 per Application Form, for processing the Application Forms procured by other intermediaries and submitted to the SCSBs.*
- 3) *Further the SCSBs and other intermediaries will be entitled to selling commission of 0.01 % of the Amount allotted (product of the number of Equity Shares Allotted and the Issue Price) for the forms directly procured by them and uploaded on the electronic system of the Stock Exchange by them.*
- 4) *The payment towards commission and processing fees will be completed within 30 days from the date of receipt of final invoice from the respective entities.*

The Issue expenses are estimated expenses and subject to change. The Issue expenses shall be payable within 30 working days post the date of receipt of the final invoice from the respective Intermediaries by our Company.

### Appraisal and Bridge Loans

Our Company has not raised any bridge loans from any bank or financial institution as on the date of this Prospectus, which are proposed to be repaid from the Net Proceeds.

### Year wise Deployment of Funds / Schedule of Implementation

As on the date of this Prospectus, no funds have been deployed on these objects. The entire Issue size is proposed to be deployed in the Financial Year 2022 – 23.

### Monitoring of Utilization of Funds

Since the proceeds from the Issue do not exceed ₹ 10,000 lakhs, in terms of Regulation 262 of the SEBI ICDR Regulations, our Company is not required to appoint a monitoring agency for the purposes of this Issue. Our Board and Audit Committee will monitor the utilisation of the proceeds of the Issue. Our Company will disclose the utilization of the Net Proceeds under a separate head in our balance sheet along with the relevant details, for all such amounts that have not been utilized. Our Company will indicate investments, if any, of unutilised Net Proceeds in the balance sheet of our Company for the relevant fiscals subsequent to receipt of listing and trading approvals from the Stock Exchange.

Pursuant to the SEBI Listing Regulations, our Company shall disclose to the Audit Committee of the Board of Directors the uses and applications of the Net Proceeds. Our Company shall prepare a statement of funds utilised for purposes other

than those stated in the Prospectus and place it before the Audit Committee of the Board of Directors, as required under applicable law. Such disclosure shall be made only until such time that all the Net Proceeds have been utilised in full. The statement shall be certified by the statutory auditor of our Company. Furthermore, in accordance with the Regulation 32(1) of the SEBI Listing Regulations, our Company shall furnish to the Stock Exchange on a half yearly basis, a statement indicating (i) deviations, if any, in the utilisation of the proceeds of the Issue from the objects of the Issue as stated above; and (ii) details of category wise variations in the utilisation of the proceeds from the Issue from the objects of the Issue as stated above.

### **Interim Use of Funds**

Pending utilization of the Net Proceeds for the purposes described above, our Company will deposit the Net Proceeds with scheduled commercial banks included in schedule II of the RBI Act. Our Company confirms that it shall not use the Net Proceeds for buying, trading or otherwise dealing in shares of any listed company or for any investment in the equity markets.

### **Variation in Objects**

In accordance with Section 27 of the Companies Act, 2013, our Company shall not vary the objects of the Issue without our Company being authorised to do so by the Shareholders by way of a special resolution. In addition, the notice issued to the Shareholders in relation to the passing of such special resolution shall specify the prescribed details as required under the Companies Act. The notice in respect of such resolution to Shareholders shall simultaneously be published in the newspapers, one in English and one in Regional language of the jurisdiction where our Registered Office is situated. The Shareholders who do not agree to the above stated proposal, our Promoter or controlling Shareholders will be required to provide an exit opportunity to such dissenting Shareholders, at a price as may be prescribed by SEBI, in this regard.

### **Other Confirmations / Payment to Promoters and Directors and Promoter's Group from the IPO Proceeds**

Except as mentioned under the section 'Details of Funds Requirement' in this Chapter above, no part of the Net Proceeds will be paid by our Company as consideration to our Promoters, our board of Directors, our Key Management Personnel or Group Companies except in the normal course of business in compliance with applicable law

## BASIS OF ISSUE PRICE

The Issue Price has been determined by our Company in consultation with the Lead Manager on the basis of the key business strengths. The face value of the Equity Shares is ₹ 10 and Issue Price is ₹ 126 per Equity Shares and is 12.60 time of the face value. Investors should read the following basis with the sections titled “Risk Factors”, “Financial Information” and the chapter titled “Our Business” beginning on page nos. 19, 121 and 72 respectively, of this Prospectus to get a more informed view before making any investment decisions. The trading price of the Equity Shares of Our Company could decline due to these risk factors and you may lose all or part of your investments.

### Qualitative Factors

Some of the qualitative factors and our strengths which form the basis for the Issue Price are:

1. Wide Range of products and services
2. Technology
3. Wide Range of products and services
4. Consistent and Standardized Product Quality
5. Experienced Promoter
6. Environmentally-friendly and Sustainable System
7. Strong Client Base

For more details on qualitative factors, refer to chapter “Our Business” on page no. 72 of this Prospectus.

### Quantitative Factors

The information presented in this section is derived from our Restated Financial Statements. For more details on financial information, investors please refer the chapter titled “Financial Statements as Restated” on page no. 121 of this Prospectus.

Investors should evaluate our Company taking into consideration its earnings and based on its growth strategy. Some of the quantitative factors which may form the basis for computing the price are as follows:

#### 1. Basic and Diluted Earnings / Loss Per Share (“EPS”)

Year ended March 31,	Basic & Diluted	
	EPS (in ₹) <sup>(1)</sup>	Weights
2022	9.48	3
2021	6.97	2
2020	0.61	1
<b>Weighted Average</b>		<b>7.17</b>

<sup>(1)</sup> Based on Restated Financials of our Company

#### Notes:

- a. Basic EPS has been calculated as per the following formula:

$$\text{Basic EPS (₹)} = \frac{\text{Net profit/ (loss) as restated, attributable to Equity Shareholders}}{\text{Weighted average number of Equity Shares outstanding during the year/period}}$$

- b. Diluted EPS has been calculated as per the following formula:

$$\text{Diluted EPS (₹)} = \frac{\text{Net profit/ (loss) as restated, attributable to Equity Shareholders}}{\text{Diluted Weighted average number of Equity Shares outstanding during the year/period}}$$

- c. Basic and Diluted EPS calculations are in accordance with Accounting Standard 20 “Earnings per Share”, notified under section 133 of Companies Act, 2013 read together with paragraph 7 of Companies (Accounting) Rules, 2014.
- d. The above statement should be read in conjunction with Significant Accounting Policies and Notes to Restated Financial Statements as appearing in “Annexure IV & V - Financial Information” beginning on page no. 121 Prospectus.

## 2. Price Earnings Ratio (“P/E”) in relation to the Price of ₹126 per share of ₹ 10 each

Particulars	P/E*
P/E ratio based on Basic and Diluted EPS as at March 31, 2022	13.29
P/E ratio based on Weighted Average EPS	17.59

## 3. Return on Net worth (RoNW)

Year ended March 31,	RoNW (%) <sup>(1)</sup>	Weight
2022	40.50%	3
2021	92.63%	2
2020	110.53%	1
<b>Weighted Average</b>	<b>69.55%</b>	

<sup>(1)</sup> Based on Restated Financials of our Company

**Note:** Return on Net worth has been calculated as per the following formula:

$$\text{RoNW} = \frac{\text{Net profit/loss after tax, as restated}}{\text{Net worth excluding preference share capital and revaluation reserve}}$$

## 4. Net Asset Value (NAV) based on actual no. of equity shares at the end of the year

Financial Year	NAV (₹)
NAV as at March 31, 2022	16.97
NAV after Issue	49.65
Issue Price (₹)	126.00

**Note:** Net Asset Value has been calculated as per the following formula:

$$\text{NAV} = \frac{\text{Net worth excluding preference share capital and revaluation reserve}}{\text{Outstanding number of Equity shares at the end of the year}}$$

## 5. Comparison with Industry Peers

We believe that there is no other listed company which is specifically comparable to us w.r.t our business model, size and financials.

- The face value of our share is ₹10.00 per share and the Issue Price is of ₹ 126 per share and is 12.60 times of the face value.
- The Company in consultation with the Lead Manager believes that the Issue price of ₹ 126 per share for the Public Issue is justified in view of the above parameters. The investors may also want to peruse the Risk Factors and Financials of the Company including important profitability and return ratios, as set out in the Financial Statements included in this Prospectus to have more informed view about the investment proposition. The Face Value of the Equity Shares is ₹ 10 per share and the Issue Price is 12.60 times of the face value i.e. ₹ 126 per share.



## STATEMENT OF TAX BENEFITS

To,  
**The Board of Directors,**  
**EP Biocomposites Limited**  
D2/12, Bicholim Industrial Estate  
Bicholim, Goa- 403504

Dear Sirs,

**Sub: Statement of Possible Special Tax Benefits available to EP Biocomposites Limited and its shareholders prepared in accordance with Securities and Exchange Board of India (Issue of Capital and Disclosure Requirements) Regulations, 2018 (“SEBI Regulations”) and the Companies Act, 2013, as amended (the “Act”).**

We hereby report that the accompanying Statement states the possible special tax benefits available to the Company and shareholders of the Company (hereinafter referred to as “**the Statement**”) under the Income Tax Act, 1961 (read with Income Tax Rules, circulars, notifications) as amended by the Finance Act, 2021 presently in force in India (together referred to as the “**Direct Tax Laws**”), the Goods and Service Tax laws & Customs Act, 1962 (read with rules, circulars, notifications) presently in force in India (together referred to as the “**Indirect Tax Laws**”).

These possible special tax benefits are dependent on the Company and/ or the Company’s shareholders fulfilling the conditions prescribed under relevant Direct Tax Laws, Indirect Tax Laws and other laws. Hence, the ability of the Company or the Company’s shareholders to derive these possible special tax benefits is dependent upon their fulfilling such conditions, which is based on business imperatives the Company may face in the future and accordingly, the Company or the Company’s shareholders may or may not choose to fulfil. The Company does not have any subsidiary as on date of the Prospectus/ Prospectus.

The benefits discussed in the enclosed Statement are not exhaustive and only cover the possible special direct and indirect tax benefits available to the Company and the Company’s shareholders. The Statement is neither designed nor intended to be a substitute for professional tax advice and each investor is advised to consult his or her own tax consultant with respect to the specific tax implications arising out of their participation in the proposed initial public offering of equity shares of the Company.

We do not express any opinion or provide any assurance as to whether:

- a) the Company or its shareholders will continue to obtain these possible special tax benefits in future; or
- b) the conditions prescribed for availing the possible special tax benefits, where applicable, have been/would be met with; and

The contents of this Statement are based on the information, explanations and representations obtained from the Company and on the basis of our understanding of the business activities and operations of the Company.

No assurance is given that the revenue authorities/ courts will concur with the views expressed herein. Our views are based on the existing provisions of law and its interpretation, which are subject to change from time to time. We do not assume responsibility to update the views consequent to such changes.

We conducted our examination in accordance with the “Guidance Note on Reports or Certificates for Special Purposes (Revised 2016)” (“**Guidance Note**”) issued by the Institute of Chartered Accountants of India. The Guidance Note requires that we comply with ethical requirements of the Code of Ethics issued by the Institute of Chartered Accountants of India.

We hereby give consent to include this Statement in the Draft Prospectus and Prospectus in connection with the proposed initial public offering of the Company.

Yours faithfully,

**For M/s. S.P. Bhandare & Associates,**  
**Chartered Accountants**  
FRN: 101157W

S. P. Bhandare  
Proprietor  
Membership No: 035615

Place: Goa  
Date: 06<sup>th</sup> June, 2022  
UDIN: 22035615AKTDYN4O30  
Email: sandip.bhandare@gmail.com

## Annexure

### STATEMENT OF POSSIBLE SPECIAL TAX BENEFITS AVAILABLE TO THE COMPANY AND COMPANY'S SHAREHOLDERS

Outlined below are the possible special tax benefits available to **EP Biocomposites Limited** (“the Company”) and to its Shareholders under the Direct and Indirect Tax Laws in force in India.

#### **A. SPECIAL TAX BENEFITS AVAILABLE TO THE COMPANY**

##### **1. Direct Tax**

There are no special direct tax benefits available to the Company.

##### **2. Indirect Tax**

There are no special indirect tax benefits available to the Company.

#### **B. SPECIAL TAX BENEFITS AVAILABLE TO THE SHAREHOLDERS OF THE COMPANY**

##### **1. Direct Tax**

There are no special direct tax benefits available to the Shareholders of the Company.

##### **2. Indirect Tax**

There are no special indirect tax benefits available to the Shareholders of the Company.

## SECTION VI – ABOUT OUR COMPANY

### INDUSTRY OVERVIEW

*The information in this section includes extracts from publicly available information, data and statistics and has been derived from various government publications, publically available documents and industry sources. Neither we nor any other person connected with the Issue have verified this information. The data may have been re-classified by us for the purposes of presentation. Industry sources and publications generally state that the information contained therein has been obtained from sources generally believed to be reliable, but that their accuracy, completeness and underlying assumptions are not guaranteed and their reliability cannot be assured and, accordingly, investment decisions should not be based on such information. You should read the entire Prospectus, including the information contained in the sections titled “Risk Factors” and “Financial Statements” and related notes beginning on page nos. 19 and 121 of this Prospectus.*

#### **Global Economic Overview**

The global economic recovery is continuing, even as the pandemic resurges. The fault lines opened up by COVID-19 are looking more persistent—near-term divergences are expected to leave lasting imprints on medium-term performance. Vaccine access and early policy support are the principal drivers of the gaps. The global economy is projected to grow 5.9 percent in 2021 and 4.9 percent in 2022, 0.1 percentage point lower for 2021 than in the July forecast. The downward revision for 2021 reflects a downgrade for advanced economies—in part due to supply disruptions—and for low-income developing countries, largely due to worsening pandemic dynamics. This is partially offset by stronger near-term prospects among some commodity-exporting emerging market and developing economies. Rapid spread of Delta and the threat of new variants have increased uncertainty about how quickly the pandemic can be overcome. Policy choices have become more difficult, with limited room to maneuver.

The global economic recovery continues amid a resurging pandemic that poses unique policy challenges. Gaps in expected recoveries across economy groups have widened since the July forecast, for instance between advanced economies and low-income developing countries. Meanwhile, inflation has increased markedly in the United States and some emerging market economies. As restrictions are relaxed, demand has accelerated, but supply has been slower to respond. Although price pressures are expected to subside in most countries in 2022, inflation prospects are highly uncertain. These increases in inflation are occurring even as employment is below pre-pandemic levels in many economies, forcing difficult choices on policymakers. Strong policy effort at the multilateral level is needed on vaccine deployment, climate change, and international liquidity to strengthen global economic prospects. National policies to complement the multilateral effort will require much more tailoring to country-specific conditions and better targeting, as policy space constraints become more binding the longer the pandemic lasts.

The global economic recovery continues amid a resurging pandemic that poses unique policy challenges. Gaps in expected recoveries across economy groups have widened since the July forecast, for instance between advanced economies and low-income developing countries. Meanwhile, inflation has increased markedly in the United States and some emerging market economies. As restrictions are relaxed, demand has accelerated, but supply has been slower to respond. Although price pressures are expected to subside in most countries in 2022, inflation prospects are highly uncertain. These increases in inflation are occurring even as employment is below pre-pandemic levels in many economies, forcing difficult choices on policymakers. Strong policy effort at the multilateral level is needed on vaccine deployment, climate change, and international liquidity to strengthen global economic prospects. National policies to complement the multilateral effort will require much more tailoring to country-specific conditions and better targeting, as policy space constraints become more binding the longer the pandemic lasts.

Despite recent increases in headline inflation in both advanced and emerging market economies, long-term inflation expectations remain anchored. Looking ahead, headline inflation is projected to peak in the final months of 2021 but is expected to return to pre-pandemic levels by mid-2022 for most economies. But given the recovery’s uncharted nature, considerable uncertainty remains, and inflation could exceed forecasts for a variety of reasons. Clear communication, combined with appropriate monetary and fiscal policies, can help prevent “inflation scares” from unhinging inflation expectations.

*(Source: <https://www.imf.org/en/Publications/WEO/Issues/2021/10/12/world-economic-outlook-october-2021>)*

#### **Indian Economic Overview**

Since the 2000s, India has made remarkable progress in reducing absolute poverty. Between 2011 and 2015, more than 90 million people were lifted out of extreme poverty.

However, the COVID-19 pandemic led India's economy into a contraction of 7.3 percent in FY21, despite well-crafted fiscal and monetary policy support. Following the deadly 'second wave,' growth in FY22 is expected to be nearer to the lower bound of the range of 7.5 to 12.5 percent – still putting India among the fastest growing economies in the world. The pace of vaccination, which is increasing, will determine economic prospects this year and beyond. Successful implementation of agriculture and labour reforms would boost medium-term growth, while weakened household and corporate balance sheets may constrain it. The economic slowdown triggered by the outbreak is believed to have had a significant impact especially on poor and vulnerable households. Recent projections of GDP per capita growth, taking into account the impact of the pandemic, suggest that poverty rates in 2020 have likely reverted to estimated levels in 2016.

The informal sector, where the vast majority of India's labour force is employed, has been particularly affected. As in most countries, the pandemic has exacerbated vulnerabilities for traditionally excluded groups, such as youth, women, and migrants. Labour market indicators suggest that urban households are now more vulnerable to fall into poverty than they were before the onset of the pandemic.

The response of the government to the COVID-19 outbreak has been swift and comprehensive. A national lockdown to contain the health emergency was complemented by a comprehensive policy package to mitigate the impact on the poorest households (through various social protection measures) as well as on small and medium enterprises (through enhanced liquidity and financial support).

To build back better, it will be essential for India to stay focused on reducing inequality, even as it implements growth-oriented reforms to get the economy back on track. The World Bank is partnering with the government in this effort by helping strengthen policies, institutions, and investments to create a better future for the country and the people through green, resilient and inclusive development.

### ***Economic Outlook***

After growing at very high rates for years, India's economy had already begun to slow down before the onset of the COVID-19 pandemic. Between FY17 and FY20, growth decelerated from 8.3 percent to 4.0 percent, with weaknesses in the financial sector compounded by a decline in the growth of private consumption. In FY21, the economy contracted by 7.3 percent.

In response to the COVID-19 shock, the government and the Reserve Bank of India took several monetary and fiscal policy measures to support vulnerable firms and households, expand service delivery (with increased spending on health and social protection) and cushion the impact of the crisis on the economy. Thanks in part to these proactive measures, the economy is expected to rebound - with a strong base effect materializing in FY22 - and growth is expected to stabilize at around 7 percent thereafter.

*(Source: <https://www.worldbank.org/en/country/india/overview#1>)*

### **Sanitation market- Global:**

Globally [3.6 billion people](#) lack access to safely managed sanitation services. Almost 8% of the global population practices open defecation. Despite significant gains — 2.4 billion people gained access to improved toilets or latrines between 2000 and 2020 — sanitation was one of the most off-track Millennium Development Goals (MDGs) globally. Today, 1.7 billion people still lack even basic services. Among those, 580 million shared improved sanitation facilities with other households, counted as “limited” services and 616 million used “unimproved” facilities. The data reveal pronounced disparities, with two thirds of people who still lacked even basic services lived in rural areas. Nearly half of them lived in sub-Saharan Africa. The world missed the MDG target for sanitation by almost 700 million people.

In addition to the challenges of providing many millions of rural households with adequate sanitation, the world continues to urbanize, and cities and small towns will increasingly bear the burden of poor sanitation — with an estimated 57% of urban dwellers lacking access to toilets that provide a full sanitation service, 16% of urban dwellers lacking access to basic sanitation services, and almost 100 million urban residents practicing open defecation.

The benefits of tackling the challenges of sanitation are manifold. Improved sanitation leads to lower disease burden, improved nutrition, reduced stunting, improved quality of life, increased attendance of girls at school, healthier living environments, better environmental stewardship, increased job opportunities and wages, improved competitiveness of cities, and economic and social gains to society more broadly.

Recent analysis shows that ending open defecation can save children's lives by reducing disease transmission, stunting, and under-nutrition, which are important for childhood cognitive development and future economic productivity. Without adequate sanitation facilities, girls are more likely to drop out of school or are vulnerable to attacks while seeking privacy.

A lack of sanitation also holds back economic growth. Poor sanitation [costs billions](#) to some countries, amounting to the equivalent of 6.3% of GDP in Bangladesh (2007), 6.4% of GDP in India (2006), 7.2% of GDP in Cambodia (2005), 2.4% of GDP in Niger (2012), and 3.9% of GDP in Pakistan (2006). The economic losses are mainly driven by premature deaths, the cost of health care treatment, lost time and productivity seeking treatment, and lost time and productivity finding access to sanitation facilities. Pollution resulting from improper disposal and treatment of wastewater and domestic faecal sludge also affects both water resources and ecosystems. At the same time, faecal sludge and wastewater can provide valuable resources (water, nutrients, soil conditioner, briquettes and energy) and economic opportunities, especially in urban areas and in water-scarce environments.

### **Strategy:**

The World Bank Group (WBG) has been addressing water and sanitation issues globally with large-scale finance and technical assistance to countries across the world. With its impact on so many aspects of human and economic development, sanitation will be one of the key drivers to ending extreme poverty by 2030, as it will be an important input to the World Bank's Human Capital Index. The World Bank Group is committed to using innovative approaches to help meet the sanitation challenges of ending open defecation, improving service delivery, and closing the loop from access to sanitation facilities through to sustainable disposal or reuse of wastewater and faecal sludge. To date, the World Bank has committed US\$10 billion to sanitation and water services, which will reach 132 million people. Earlier work by the Bank on advocacy, innovative approaches and policy dialogue, has led to large scale impact in rural and urban sanitation projects in countries such as India, Vietnam, Egypt, Haiti, Mozambique, Tanzania, Ethiopia, Bangladesh, Bolivia and Ghana.

Another strategy to expand access to sanitation — in both urban and rural locations — is the recognition that private sector participation will be key in helping us meet the needs of all citizens. To accelerate access to basic sanitation services for 2.4 billion people, and access to safely managed services for an additional 2.2 billion people, governments will need to further leverage the private sector's professional capacity and investment. Partnering with the private sector can tap into its capacity to innovate new affordable and aspirational products and service delivery for poorer households, strengthen distribution and supply chains, increase responsiveness to customer demand, and apply the best social and commercial marketing practices to change behaviour, a particularly crucial consideration for sanitation. Private sector participation can also be tapped into for the efficient collection, conveyance, treatment and proper disposal/reuse of faecal sludge and wastewater.

(Source: <https://www.worldbank.org/en/topic/sanitation#1> )

### **Sanitation – Indian Overview**

India has made rapid progress in ending open defecation across the Country which is having a huge impact on improving water, sanitation and hygiene (WASH). Just a few years ago, in 2015, nearly half of India's population of around 568 million people suffered the indignity of defecating in fields, forests, bodies of water, or other public spaces due to lack of access to toilets. India alone accounted for 90 per cent of the people in South Asia and half of the 1.2 billion people in the world that defecated in the open.

By 2019, according to the latest estimates, the number of people without access to toilets has reduced significantly by an estimated 450 million people. A tremendous achievement, only possible because of the Swachh Bharat Mission (SBM) (Clean India Campaign), led by the Prime Minister. UNICEF has been a proud partner of the Swachh Bharat Mission. Going forward, it is important to ensure that there is sustained usage of toilets by, all at all time.

Whether in the cities or the countryside, open defecation has historically been most prevalent among the poorest citizens. This practice amounted to tonnes of faeces introduced daily into the environment, which regularly exposed India's children to excrement through direct contact. The risk of spreading diarrheal and waterborne diseases is compounded by the lack of regular hand washing and microbial contamination of water in their homes and communities. The situation contributed to nearly 100,000 diarrhoeal deaths of children under five years in India.

Poor sanitation can also have a ripple effect when it hinders national development because workers are suffering from illnesses and living shorter lives, thereby producing and earning less, and unable to afford education and stable futures for their children. Inadequate water, sanitation and hygiene (WASH) services in India's health facilities, contributes to



the high neonatal mortality rate, which is currently 24 deaths per 1000 live births. Sepsis – mostly spread in health facilities – contributes to 15 per cent of the overall neonatal mortality and 11 per cent of maternal deaths. And the risks do not end there when they are brought home to a community that lacks toilets.

In India's schools, recent reports also showed that 22 per cent did not have appropriate toilets for girls, 58 per cent of preschools had no toilet at all and 56 per cent of preschools had no water on the premises. Less than 50 per cent of the population has access to safely managed drinking water (located on premises, available when needed and free of contamination). Chemical contamination of water, mainly through fluoride and arsenic, is present in 1.96 million dwellings. Moreover, two-thirds of India's 718 districts are affected by extreme water depletion, and the current lack of planning for water safety and security is a major concern. India has made rapid progress in ending open defecation across the Country. The number of people defecating in open in India has reduced significantly by an estimated 450 million people. However, we all need to ensure sustained use of toilets and hygiene practices by all, at all times.

(Source: <https://www.unicef.org/india/what-we-do/water-sanitation-hygiene>)

### **Ensuring Sustainability of Sanitation Services**

On the 150th birth anniversary of Mahatma Gandhi, India celebrated the end of the five-year Swachh Bharat Mission (SBM), the world's biggest behaviour change programme to eliminate open defecation. While the country was commended for having gone from 39 per cent to almost universal toilet coverage in just five years, a lot was remained to be accomplished.

According to the national statistics, over 100 million household toilets were constructed by the deadline benefitting 500 million people across 630,000 villages, but the government acknowledged that more had to be done. Consistent reinvestment in building up and strengthening the rest of the sanitation cycle and reaching last-mile populations remained a priority in the way forward.

To sustain the gains achieved in the first phase of SBM, the Government of India launched the second phase of the flagship programme to ensure that communities remain clean by preventing faecal waste from flowing into fields and contaminating the surroundings.

According to the State of the World's Sanitation Report by UNICEF and WHO, over half the world's population (around 4.2 billion people), despite the progress being made in sanitation, use services that leave human waste untreated, threatening human and environmental health. This hampers child development and social and economic progress, making the fulfilment of child rights, good physical, mental and social well-being unattainable in the absence of safe sanitation.

Getting thousands of gram panchayat to reach this milestone calls for decentralized planning, investment in human resources, budgetary provision, and an excellent supervisory and management structure to ensure that the behaviour change activities are undertaken even after the initial declaration of ODF status.

(Source: <https://www.unicef.org/india/what-we-do/ending-open-defecation>)

### **India Water and Wastewater Treatment (WWT) Technology Market**

The Indian water and wastewater treatment (WWT) technology market was valued at USD 2,042.91 million in 2020. The COVID-19 outbreak has been negatively affecting the economy of India. The pandemic negatively affected the operations of several end-user industries of the market studied, which reduced the outflow of industrial wastewater. The COVID-19 pandemic resulted in a huge drop in oil demand. The drop in demand resulted in the futures market for oil turning negative. This resulted in the decreased investments and a major scaling back in the drilling activities. As a result, the demand for water treatment technologies in the industry declined. In the food and beverage industry, labour shortage and the shutdown of plants reduced the food production levels in 2020. The food and beverages industry accounts for ~3% of India's GDP, and it is the single largest employer in the country, with more than 7.3 million workforces. Food items other than staple food and ready-to-eat food witnessed a significant decline, owing to the decreased food consumption in restaurants and hotels. These trends negatively impacted the growth of the food industry. Furthermore, in the pulp and paper industry, reduced imports of packaging material by major consumers resulted in a domestic oversupply of pulp and paper products in the manufacturing countries.

This oversupply issue is negatively affecting the growth of the industry.

- In the medium term, the rapidly diminishing freshwater resources and growing wastewater complexities are likely to drive the demand for water and wastewater treatment technologies in India.

- The high cost of water treatment plants and the impact of the COVID-19 pandemic are expected to hinder the growth of the market studied.
- Innovations in water treatment technologies are anticipated to act as an opportunity for the market studied.

**The Indian water and wastewater treatment (WWT) technology market is segmented by equipment type and end-user industry:**

Equipment Type	Treatment Equipment	Oil/Water Separation Suspended Solids Removal Dissolved Solids Removal Biological Treatment/Nutrient and Metals Recovery Disinfection/Oxidation Other Treatment Equipment
	Process Control Equipment and Pumps	
End-user Industry	Municipal Food and Beverage Pulp and Paper Oil and Gas Healthcare Poultry and Agriculture Chemical and Petrochemical Other End-user Industries	

#### **The Municipal Segment to Dominate the Market:**

Wastewater treatment is necessary and used across India in different cities. The major applications of treatment technologies include preliminary treatment, primary and secondary treatment, tertiary treatment, biological nutrient removal (BNR), resource recovery, and energy generation. Municipal wastewater treatment involves a lot of biomass. Therefore, biological treatment is a major step used for the treatment of bio waste. Wastewater technology is primarily used in municipal wastewater treatment by the municipal authority of various cities across India. The constant rise in the urban population in major Indian cities has created the demand for wastewater treatment facilities in the country to balance the population with the availability of freshwater. According to a survey by the United Nations, in 2030, 40.76% of the country's population is expected to reside in urban areas. As per the World Bank, India, along with China, Indonesia, Nigeria, and the United States, will lead the world's urban population surge by 2050.

In the coming years, desalination is expected to be a prominent technology in the Indian cities for the filtration of water due to the rising scarcity of fresh water in the country. Desalination is a process through which the salinity of seawater is removed, thereby converting it into potable water. The two main desalination processes are the distillation process and the membrane process. The distillation process includes multi-stage flash evaporation (MSFE), multi-effect distillation (MED), vapor compression (VC), and multi-effect distillation-vapor compression (MED-VC) cover approximately 50% of the total desalination process.

(Source: <https://www.mordorintelligence.com/industry-reports/india-water-and-wastewater-treatment-wwt-technology-market>)

#### **Fibre Reinforced Plastic (FRP) Composite Market**

Global Fibre-reinforced Polymer (FRP) Composites Market is valued at 6,194 kilotons in 2020.

The market was negatively impacted by COVID-19 in 2020. Considering the pandemic scenario, the construction activities were stopped temporarily during the lockdown in order to curb the spread of COVID-19. For instance the construction output had decreased by 28.4% in the euro area (EU-19 member countries) and by 24% in the European Union (EU-27 member countries) in April 2020 compared to April 2019, mainly due to the impact of the COVID-19. This decreased the demand for FRP composites materials in the construction sector. However, the demand for FRP composites has increased significantly to construct medical shelters for COVID-19 patients across different parts of the

globe, including the United States, India, and others. For instance, in June 2020, Tata Steel introduced FRP composites-based 500-bed Greenfield hospital for quarantining COVID-19 patients in Kasargod, Kerala, India.

Over the short term, the increasing demand from the construction sector and the growing demand for energy efficiency in the aerospace and automotive industries are expected to drive the market's growth. On the flip side, declining automotive production, high initial cost, and technical challenges regarding the FRP composites outbreak are expected to hinder the growth of the market studied. The building and construction industry is expected to dominate the fibre-reinforced polymer (FRP) composites market over the forecast period.

Asia-Pacific is expected to represent the largest market, owing to the increasing consumption from countries such as China, India, and Japan.

### **Key Market Trends**

- Increasing Demand from Transportation Sector
- Fibre-reinforced polymer (FRP) composites are widely used in the transportation industry in automotive, aircraft, helicopters, and spacecraft to boats and ships.
- Fibre-reinforced polymer (FRP) are composites used in almost every type of advanced engineering structure, with their usage ranging from aircraft, helicopters, and spacecraft through to boats, ships and offshore platforms, and to automobiles.
- In the transportation industry, fibre-reinforced polymer (FRP) composite material serves as the best alternatives to conventional materials like steel or aluminium owing to weight and cost issues. FRPs are ideal replacements for wood, in marine waterfront environments, or on ships, where they reduce the structural weight and enhance corrosion resistance.
- Overall, FRP composites can weigh up to 75% less than steel while being lighter and stronger than concrete. Owing to this, they are widely being used in the transportation industry. Overall, the rising production of various modes of transportation is expected to drive market growth.

(Source <https://www.mordorintelligence.com/industry-reports/fiber-reinforced-polymer-frp-composites-market>)

## OUR BUSINESS

This chapter should be read in conjunction with, and is qualified in its entirety by, the more detailed information about our Company and its financial statements, including the notes thereto, in the sections titled ‘Risk Factors’ and ‘Financial Information’ and the chapter titled ‘Management Discussion and Analysis of Financial Condition and Results of Operations’ beginning on page nos.19, 121 and 141 respectively of this Prospectus.

Unless otherwise indicated, the financial information included herein is based on our Restated Financial Statements included in this Prospectus. For further information, see “Financial Statements” on page no. 121 of this Prospectus.

Unless the context otherwise requires, in this section, reference to “we”, “us”, “our”, “Company” or “Our Company” refers to EP Biocomposites Limited.

### OVERVIEW

Our company was incorporated on January 17, 2020 and is into manufacturing and supply of fibre re-inforced polymers (FRP) products such as door shutters, frames, Biodigester Tanks, Bio toilets and allied products for construction and Industrial applications which meets customer requirements. The Company got into highly potential sector of waste water recycling in 2021. The company has taken over the running business of our promoter, ‘M/s Om Ventures’, a sole proprietorship through a business transfer agreement dated August 31, 2021. For further details please refer to “History and other corporate matters” beginning on page no. 98 of this Prospectus.

We focus on giving sanitation solutions to those who do not have access to toilets, as well as to those who have toilets but face trouble treating and managing the waste through septic tanks. We provide sanitation infrastructure and human waste management solutions and services, involving innovative and simple bio-digester technology licensed from Defence Research and Development Organisation (DRDO) and Industry Interface and Technology Management, operating under the aegis of DRDO, Ministry of Defence, Government of India. The anaerobic bio-digester technology helps users manage waste onsite, without depending on expensive and energy-consuming sewage infrastructure.

The Sewage Treatment Plant helps contaminant concentrations to be lowered to a safe level before wastewater can be reused or returned to the environment. The effluent water treatment - a technique used for processing industrial wastewater for reuse or safe discharge to the environment. The company also specializes in FRP allied products. FRP which stands for Fiber Reinforced Polymer is an eco-friendly substitute for wood that has long been the chosen building material - a limited resource that has resulted in major environmental problems, such as fast forest decline.

The group has supplied more than 2, 00,000 doors thereby saving thousands trees and has supplied more than 2,500 Bio toilets to households helping in reduction of open defecation thereby contributing to clean and green surroundings. For our innovation and continuous contribution for betterment of society, we as a group have been recognized and acclaimed with the National Award for Outstanding Efforts in Entrepreneurship in MSEs (Manufacturing).

Our revenue from operations was Rs 805.96, Rs 294.80 lakhs and Rs 56.81 lakhs for Fiscal 2022, 2021 and 2020 respectively. It may be noted that, despite pandemic the company has been growing exponentially

Our EBITDA was Rs 116.60, Rs 46.42 lakhs and Rs 4.31 lakhs for Fiscal 2022, 2021 and 2020 respectively. Our restated profit after tax was Rs 80.94, Rs 35.80 lakhs and Rs 3.15 lakhs for Fiscal 2022, 2021 and 2020 respectively.

### Business response to COVID-19

Since the onset of the COVID-19 pandemic in March 2020, our Company has responded swiftly by implementing various processes to ensure our operations continue seamlessly. In 2020, cases of the novel corona virus started rapidly increasing in India, which led the government of India to impose a nationwide lockdown. The spread of Covid-19 and its recent developments have had and might continue to have repercussions across local, national and global economies. We are engaged in the manufacturing and supply of fibre re-inforced polymers (FRP) products such as door shutters, frames, Biodigester Tanks, Bio toilets & allied products for construction and industrial applications. A strong base of loyal customers and diversified product range caters to multiple customer segments like Hotels, Industry, Government besides Individuals & construction sector helped us continue our operations inspite of Covid. An Increase in Raw material prices due to its shortage in the market has affected our profitability. Average of nearly 15% increase in raw material costs has impacted our bottom line, through the Top line has grown healthily. We continued our operations after making arrangements to meet the government’s requirements on sanitization, people movement and social distancing. However the raw material prices have started falling in place with economy opening up.

We consider that our swift response and proactive steps taken have mitigated the impact of COVID- 19 pandemic on our business and personnel thus far. And we were able to remain growth oriented and profit oriented. The future impact of COVID-19 or any other severe communicable disease on our business and results of operations depends on several factors including those discussed in “Risk Factors” on page 19 of this Prospectus. We are continuously monitoring the economic conditions and have outlined certain measures to combat the pandemic situation and to minimize the impact on our business. For more details, see Risk Factors Affecting Results of Operations and Financial Condition – COVID-19 Pandemic on page 19 of this Prospectus.

## **STRENGTHS**

### **1. *Partnerships with industry and non-governmental players***

DRDO, the inventor of the technology, is our technology partner. NGOs and non-profit organizations are our partners in installing household and community toilets, and creating awareness. In association with them, we reach out to the rural populace and urban slums. Besides our basic product range of Doors, Bio Digester Toilets and STP / ETP's we would like to tie up with Entrepreneurs offering containerised STPs & Precast products, SMC tanks etc. considering a huge demand for these in our targeted market segment.

In order to take advantage of our diversified product portfolio and existing client base of above mentioned products, we are planning to diversify our product portfolio by adding Delivery of clean water Dispensers by partnering with Wayout International AB (Wayout), a foreign entity. Currently we are at initial stage and working on the feasibility model. Upon completion of the feasibility model, we will enter into the agreement with Wayout International AB (Wayout) & will foray into this space.

### **2. *Technology***

The company utilises sandwich technology from TIFAC (Technology investigations & Forecasting) for FRP Doors and unique DRDO (Defence research Development Organisation) Biodigester technology for bio-toilets to offer Greener products for Swachh Bharat Mission. The company is a licensee (through transfer of technology) and has partnered with DRDO for technology commercialization for large-scale deployment of sanitation systems. The technology is effective in resolving the huge challenge of open defecation in India. We also continue to explore more application areas of the technology. With many successful projects in place, and recognition from the government, industry and academia – we have overcome many entry barriers, as also made a mark for ourselves.

### **3. *Wide Range of products and services***

We are a manufacturing company having varied product segments. Our diversified portfolio of products and services for greener and safer planet consists of Fibre Reinforced Polymer (FRP) doors and allied products, Bio Digester toilets with one of its kind DRDO technology and actively contributing to wastewater recycling through its solution in Sewage Treatment Plant (STP) and Effluent Treatment Plants.(ETP)

### **4. *Consistent and Standardised Product Quality***

Our Company has received ISO Certification from Paramount Quality Certifications and was found to be in accordance with the requirements of ISO 9001:2015 in regards to manufacturing and supply of fibre reinforced polymer (FRP) products such as door shutters, frames, Biodigester tanks, bio toilets and allied products for construction and Industrial Applications. Our Company undertakes stringent quality control as mandated in its Quality Manual to adhere to the quality norms of ISO. The brief details of the internal Quality Manual detailing the Quality Management System (QMS) are enumerated in the section “Quality Manual” in the chapter “Our Business” on page no. 72 of this Prospectus

### **5. *Experienced and Qualified Team***

The Promoter and the management team of our Company have significant industry experience and have been instrumental in the consistent growth of our Company's performance. Our Promoter Mr. Rajkumar Kamat has close to 3 decades of business experience and has been instrumental in the consistent growth of our Company's performance. He has been the main guiding force behind the growth and business strategy of our Company. A dynamic and multi-faceted personality, he handles the marketing, operations, finance, and business growth and development of the organization. Further, our promoter is supported by a team of well qualified and experienced professionals. We believe that our management team's experience will enable us to continue to take advantage of both, current and future opportunities. It is

also expected to help us in addressing and mitigating various risks inherent in our business, including significant competition. For further details of our Promoter’s experience and background, please refer the chapter titled “Our Promoter and Promoter Group” on page no. 113 of this Prospectus.

### 6. *Environmentally-friendly and Sustainable System*

**Bio STPs** + utilizes multiple technologies innovatively , to customize the waste treatment process for optimum results and minimal cost, while delivering output fully in line with the latest 2020 pollution control norms, thereby contributing effectively to environment protection. The mission is to become the leader in sanitation and water recycling space in India by introducing the most technologically advanced yet environmentally friendly products. By the year 2025, the company hopes to achieve their goal of recycling 100 million liters of water every day.

The bio-toilet is a complete environmentally-friendly system. The faecal matter isn’t left to ground, nor does it pollute the ecology in any manner. The system ensures that the human waste is completely degraded or “eaten up”. The effluent water is pathogen-free, can be re-used or left to seep into the ground. Even as it percolates, it recharges the water table. Above all, the system doesn’t require any energy source or other input for treatment, rather gives out utilizable biogas. There is a growing need to conserve more water and make India more self-sustainable. The bio-toilet can be easily installed without high cost, for the economically challenged or for the people at the bottom of pyramid (BoP). Bio STP Plus utilizes multiple technologies innovatively, to customize the waste treatment process for optimum results and minimal cost. Our company also manufactures FRP Doors that are unique, eco-friendly and greener alternatives to wooden doors. Our company also manufactures FRP Doors that are unique, eco-friendly and greener alternatives to wooden doors.

### 7. *Strong Client Base*

We have developed a strong client base for our product and services. Also, for our products we have developed corporate client base as well including public sector undertakings (PSUs), publicly-listed and private companies, construction, infrastructure and Hotel companies, Foundations, NGOs and other organizations. We have expanded our market across, urban, peri-urban and rural India.

### **OUR STRATEGIES**





### ***1. Partnerships with industry and non-governmental players***

DRDO, the inventor of the technology, is our technology partner. NGOs and non-profit organizations are our partners in installing household and community toilets, and creating awareness. In association with them, we reach out to the rural populace and urban slums. Besides our basic product range of Doors, Bio Digester Toilets and STP / ETP's we would like to tie up with Entrepreneurs offering containerised STPs & Precast products, SMC tanks etc. considering a huge demand for these in our targeted market segment.

In order to take advantage of our diversified product portfolio and existing client base of above mentioned products, we are planning to diversify our product portfolio by adding Supply of Safe & pure drinking water in partnering with Wayout International AB (Wayout) a swedish entity and using their water Micro factories. Currently we are at initial Stage and working on the right feasibility mode along with wayout. As soon as this is established we will work on implementing the agreement and foray into this space, which aims at elimination of use of plastic bottles in the water dispensation cycle - Another Environment as a friendly product line as a part of AQUA Division.

### ***2. Market Expansion***

We propose to cater to both, domestic as well as international markets. We aim to further develop our domestic sales networks in two ways: By Strengthening our local presence in Goa by having full scale showroom and increase the number of retailers and secondly by creating new distribution channels in non-penetrated geographies considering various cities. We currently supply in Goa , North Karnataka (Belgaum, Hubli & Dharward) and United Arab Emirates (UAE). We want to expand our market by leveraging our business platform and tie up with Business Associates / Distributors throughout India. Our company is focusing on increasing growth in the export markets like the neighbouring hilly & coastal countries like Nepal, Bhutan, Sri Lanka, and Bangladesh to market Bio Digester Tanks & North America & Europe to Market FRP Doors in a phased manner. Exports brings in better realization of margins, prompt delivery due to faster and planned pace of projects, better payment terms and access to larger markets. This also reduces the risk of dependence on a single market and ensures that any slowdown in the market would not affect overall growth and performance of our company. We believe that we have developed good clientele network in domestic markets and going forward shall be able to take advantage of our existing operations and network to expand these markets

### ***3. Investing in Human Resources and Building a Professional Organization***

We believe that the successful implementation of our business and growth strategies depends on our employees' commitment to our vision. We also believe that to sustain our future growth, we need to continue to train and empower our employees. As we expand our business into other geographical region, our ability to successfully train our existing and new employees will play a crucial role. We believe in transparency, commitment and coordination in our work, with our suppliers and customers. We have a blend of experienced, young and sufficient staff for taking care of our day to day operations.

### ***4. Networking***

Our promoter is heading the Goa region of BNI (Business Network International), a Global Organization with more than 2, and 70,000 Businessmen & Professional as members worldwide. His key position in various organizations helps him connect easily to these Entrepreneurs for support in Pan India & Global Expansion. EP Biocomposites limited is a member of Business Network International. All these connections help us network with, and build relationships. Thus corporations and the non-profit sector help us in reaching out to users and clients.

### ***5. Strengthening Supply Chain***

We would like to focus on our core competency of composites manufacturing products and composites develop a strong supply chain for other products. We have developed bonds with suppliers of Raw Materials, besides Precast & Aluminium Toilet manufacturers. As we embark on the growth trajectory, idea would be to have multiple suppliers for each item with close communication & collaboration.

### ***6. Digital Marketing***

We actively use social media for customer engagement, service provision and interaction with our vendors. We intend to increase our touch points and engagement with customers through various digital and technology initiatives. We are already active on social media websites such as Instagram, LinkedIn and Face book. We believe that the granularity of data available with us, both geographically and across various segments will enable us to enhance our distributions and help us to increase our customer base both locally and globally.

## DETAILS OF OUR BUSINESS

### Location

<b>Registered Office</b>	C/O OM Ventures, Shed No D-2/12, Bicholim Industrial Estate, Bicholim, Goa - 403504
<b>Corporate Office</b>	1 <sup>st</sup> Floor, B.R. Commercial Centre, Opp. Parade Ground, Campal, Panaji, Goa-403001

Our Books of Accounts are being maintained at our Corporate Office and not at our Registered Office.

### Our Reach

Presently, Goa and North Karnataka (Belgaum, Hubli & Dharward) are the regions in which the company is operating through its Sales Representative, Retailers & Business Associates.

Our State Wise Revenue details are as illustrated below:

(Rs in lakhs)

States	2021-22		2020-21		2019-20	
	Revenue	%	Revenue	%	Revenue	%
Goa	773.27	95.94%	286.18	97.07%	54.98	96.77%
Karnataka	24.80	3.08%	8.63	2.93%	1.84	3.23%
Maharashtra	4.61	0.57%	-	-	-	-
Exports	3.28	0.41%	-	-	-	-
	<b>805.96</b>	<b>100%</b>	<b>294.81</b>	<b>100%</b>	<b>56.81</b>	<b>100%</b>

### Our Segment Wise Revenue

(Rs in lakhs)

Particulars	2021-22		2020-21		2019-20	
	Revenue	%	Revenue	%	Revenue	%
• Corporate	623.01	77.30%	155.98	52.91%	35.73	62.89%
• Traders	69.87	8.67%	30.33	10.29%	3.02	5.31%
• Individuals	113.08	14.03%	108.50	36.80%	18.07	31.81%

### Our Target Market

Name Of The Product	Target Market			
	Builders & Contractors	Hotel & Industries	Government & Institutions	Individuals
FRP Doors & Frames	Major	Minor	Minor	Major
FRP Bio Digester Tanks & Toilets	Minor	Minor	Major	Major
Customized & FRP Allied Products	Minor	Major	Minor	-
Sewage & Effluent Treatment	Minor	Major	Minor	-

## PRODUCTS AND SERVICES

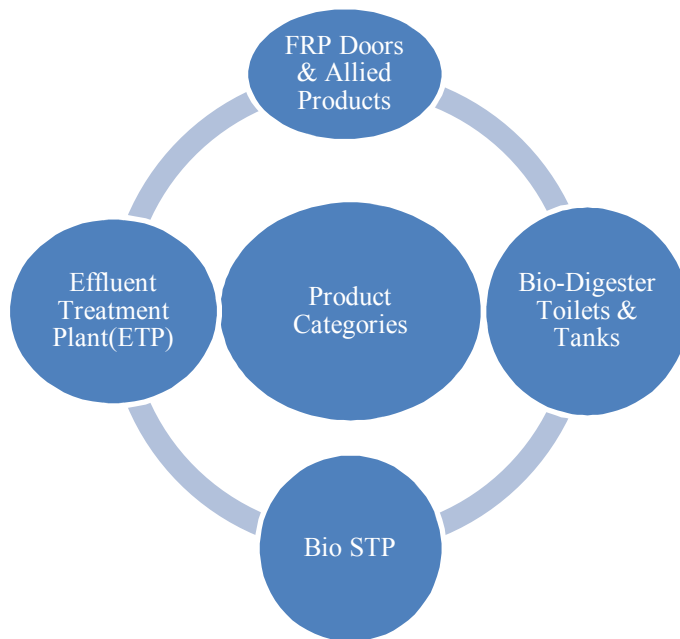

The product categories being offered by EPBL are as follows:

### 1. Bio-Digester Tank



Bio-Digester Tank



AMI Inoculum (Bacteria) Plant



FRP Toilet With Bio-Digester Tank

It is a unique sanitation technology which provides complete breakdown of human waste at all scales. With DRDO certified technology, an Inoculum's bacterium deactivates 99% of pathogens under anaerobic conditions, being easily operable in even extreme weather conditions. The only by-products are water, which is fit for gardening, and odourless gas. Only one bacterial inoculation and this system can degrade even detergents and phenyl.

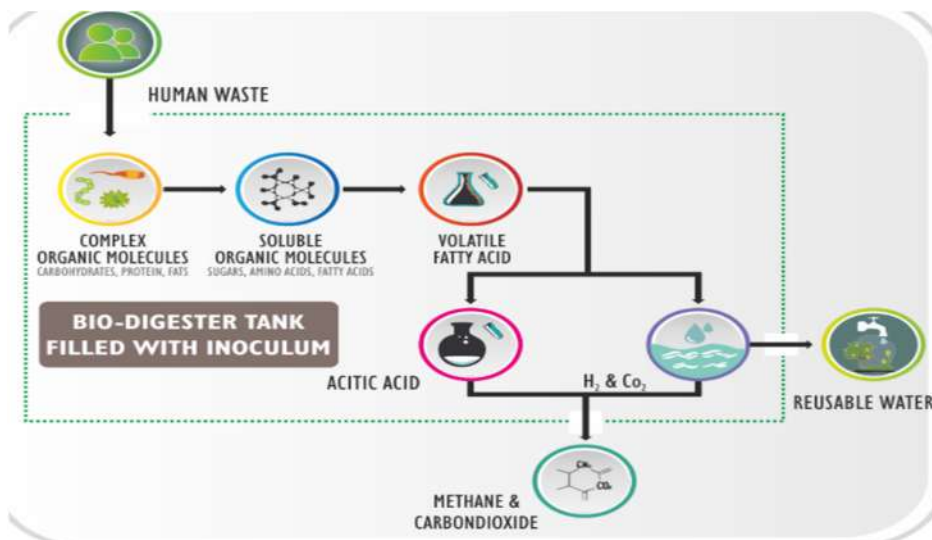

With the cutting-edge technology of DRDO, benefits of the Bio-Digester toilet are many; some of these benefits are:

- Eco-Friendly
- Cost Effective
- Wide applicability in varying climatic conditions and usage
- Simple design and construction
- Maintenance Free and no recurring costs
- Minimum water consumption

### The Technology

Bio-digester uses a consortium of anaerobic bacteria that have been screened and gradually adapted to work at temperatures as low as  $-5^{\circ}\text{C}$  through the isolation of psychrophilic bacteria from Antarctica/Siachen. These act as inoculums (seed material) to the bio-digesters and convert the organic waste into methane and  $\text{CO}_2$ . The anaerobic process inactivates the pathogens responsible for water-borne diseases. Bio-digesters serve as reaction vessels for bio-methanation and provide anaerobic conditions and the required temperature for the bacteria.

We manufacture/produce the entire range of base products: bio-toilets, bio-tanks and bacterial culture, and services consultancy. We have been working on product innovations and applying this technology to varied sanitation requirements.

### Installation of bioloo

The installation of bioloo, comprising of super-structure and the bio-tanks (specially designed) below or behind the toilet structure, are carried out at the site. The site engineer at the installation site ensures that everything is according to the plan and drawing. Pre-fabricated toilet is supplied to be installed at the site as per the requirement and budget. The toilet super-structure and the bio-tank are made in the plant and transported to the place of installation, and our team members fit the toilet at the customer site.

## 2. BIO STP

### Sewage Treatment Plants



The company Designs, Fabricates, Supplies, Erects and Commission Sewage Treatment Plants (STP) for treating sewage generated by Industry, large colonies, Hotels, Hospitals, IT Parks and commercial buildings. As per new National pollution control norms, the Sewage Treatment Plant (STP) has become a statutory requirement of all the State Pollution Control Boards.

#### *Features of BIO- STP*

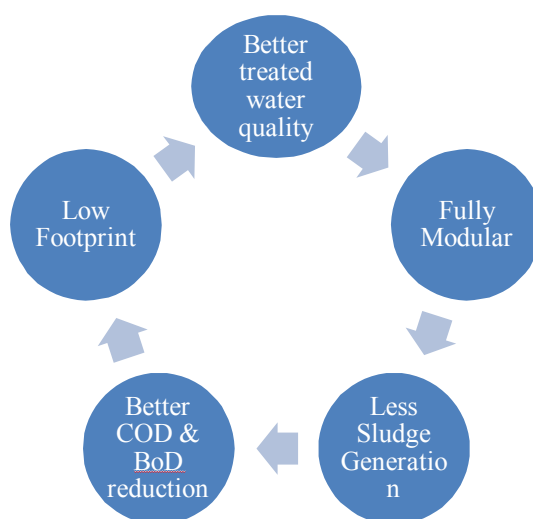

#### **The Principle**

STP work on the principle of Aerobic Treatment with the help of aerobic bacteria, which is most conventional and proven method throughout the world known as anaerobic digestion. Bio STP combines the Aerobic & Anaerobic Treatment.

#### **Technologies Used**

- MBBR: Moving Bed Bio reactor
- SBR: Sequential Bioreactor
- MBR: Membrane Bio Reactor

## MBR: Membrane Bio Reactor

This technology is a combination of membrane process like microfiltration, nanofiltration, and ultrafiltration with biological waste water treatment process. It is one of the most important innovation in waste water treatment as it overcome the drawbacks of the conventional ASP(Activated Sludge Process), including large space requirement for secondary clarifiers, liquid–solid separation issues, production of excess sludge, and limitations with removal of recalcitrant. Its claimed ability to hold and sustain mixed liquor suspended solids (MLSS) of three to four times than what is possible in the conventional aeration tanks which in turn offers minimization of the footprint of the treatment plant.

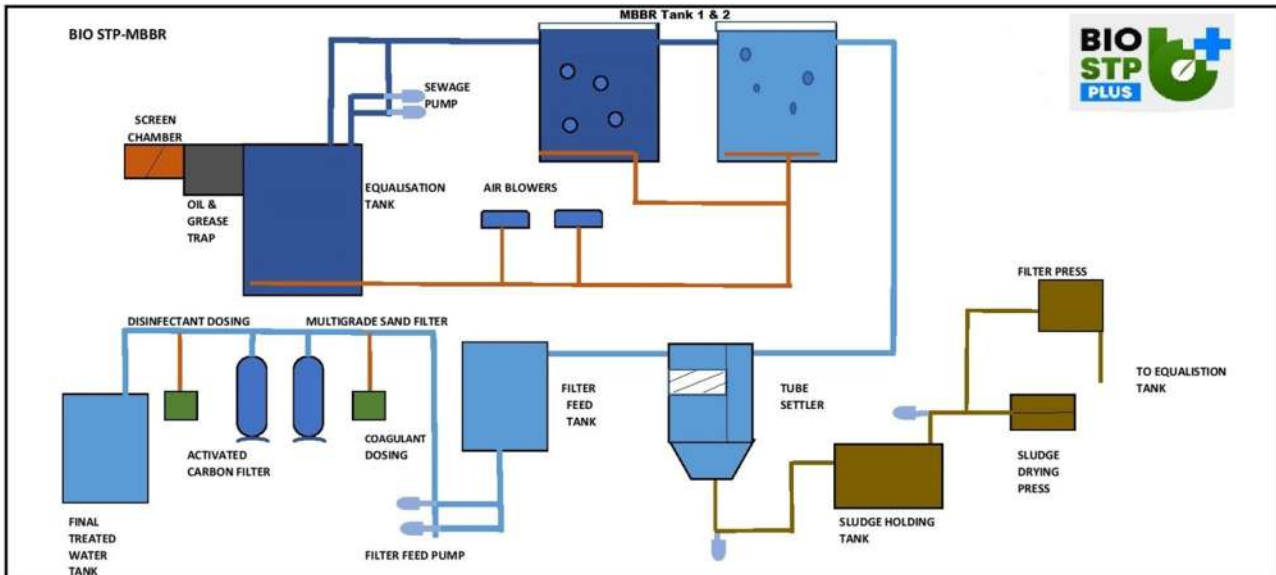

## TYPES OF BIO STP

### ➤ *BIO STP-Containerized Type*

**Capacity:**  
**Technology:**

1–50KLD  
MBBR/SBR/MBR

### Features:

- Semi-automatic Operation.
- Required less space.
- Very Compact and aesthetic.
- Reduced Installation and commissioning time on site.
- Plug and play operation.
- Easy installation and transportation.
- Customised product.
- Civil Work – Collection Tank and Container Foundation.

**Typical Customer Segment:** Suitable segments for setting up the plant are IT Complex, Hotels & Restaurants, Labour Camps, etc.

### ➤ *BIO STP- Civil Type*

**Capacity:** 1KLD TO 1 MLD  
**Technology:** MBBR/SBR/MBR

### Features:

- Semi-automatic Operation
- Minimum Maintenance Required
- Underground Civil Work (RCC) Construction



- Erection and commissioning by Trained and experienced Team
- Treated Water can use for Irrigation, Gardening, Flushing Purpose

**Typical Customer Segment:** Suitable segments for setting up the plant are Large Societies, Hospitals, Hotels, Large Industries, and Commercial Complex.

### Membrane Bio- Reactor

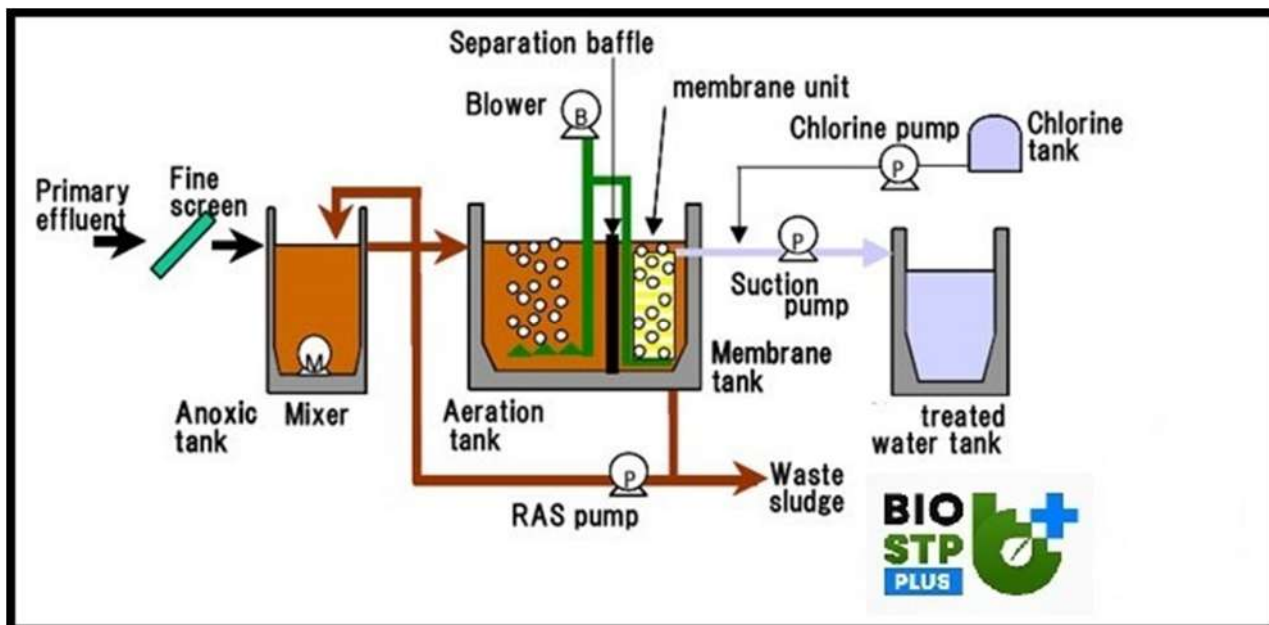

### 3. Effluent Treatment Plan



It is Designed, Manufactured, Supplied, Erection and Commissioning Effluent Treatment Plant (ETP) on Turnkey basis for various types and natures of waste Waters, effluents which helps in removing contaminations from wastewater and Industrial effluent, water that are used by Industry , hospitals, & Hotel are degraded in quality as a result of the introduction of contaminating constituents during Process & Uses Like - Organic wastes, suspended solids, bacteria, Oil & Grease , Chemicals, Metals, Resins, Colorant, & Surfactant are pollutants that are commonly called Effluent. It includes Physical, Chemical, and Biological Process to remove Physical, Chemical, and Biological contaminations. Its objective is to produce an environmentally safe water waste stream.

**Process** - The effluent samples are analysed for different effluent parameters as per nature and compositions, carry out the treatability studies by using different methods and then designed treatment schemes, processes accordingly to suit the purpose and need.

The ETP systems are very compact, tailor made designs, portable, requires very less foot-print to accommodate, energy efficient. Customised up-gradation, modification in the existing ETP system to achieve desired limiting standard as per the norm by the Pollution Control Board (PCB).

## ETP CHEMICAL TREATMENT

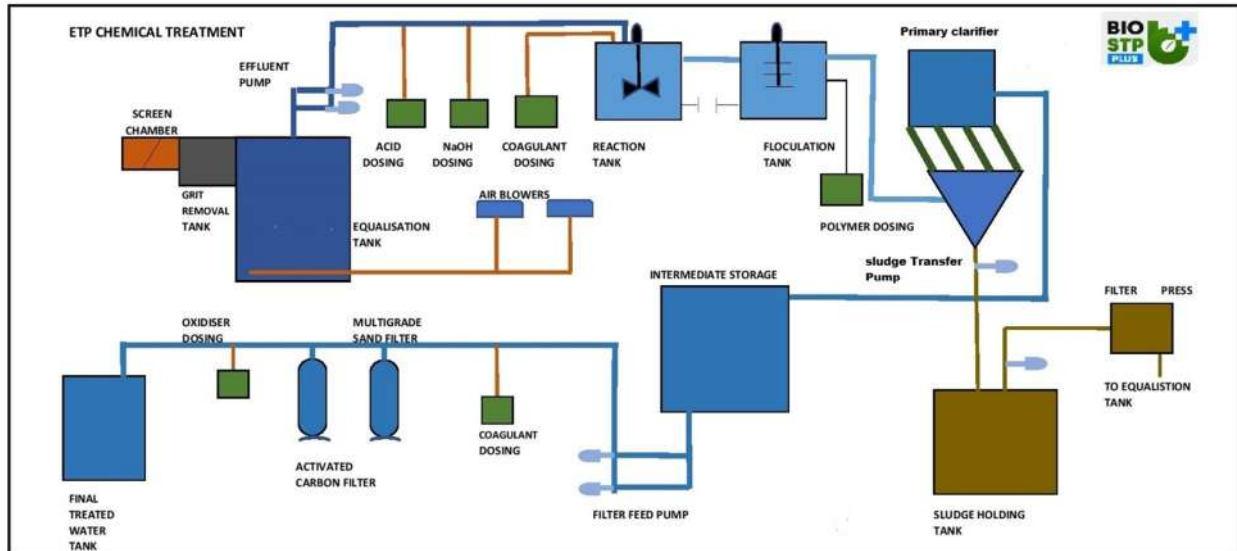

## TYPES OF ETP:

### ETP Containerised Type

Capacity: 1–50KLD, as per client Requirement Technology: Physical/Chemical/Biological/UI Filtration

#### Features:

- Semi-automatic Operation.
- Required less space.
- Very Compact and aesthetic.
- Plug and play operation.
- Ease of installation & transportation.
- Customised product.
- Civil Work for Collection Tank and Container Foundation.
- Reduced time of Installation and commissioning on site

### ETP – Civil Type

Capacity: 1KLD TO 1MLD

Technology: MBBR/SBR/MBR

#### Features:

- Semi-automatic Operation
- Minimum Maintenance Required
- Underground Civil Work (RCC) Construction
- Erection and commissioning by Trained and experienced EP Biocomposites Ltd Team
- Treated Water can use for Irrigation, Gardening, Flushing Purpose

#### 4. FRP Doors



FRP (Fibre Reinforced Polymer) doors are made of versatile, man-made composite materials that are rapidly becoming popular around the world, replacing wood, metal and concrete as sustainable substitutes. Usage of FRP ranges from Aerospace and Defence to housing, marine construction, transportation, chemical and other engineering uses. Shutter and frames

#### Other Products

1. EPEE Security cabins
2. EPEE Frp louvres
3. EPEE Garden benches
4. EPEE Dustbins
5. EPEE Sundar Patti
6. EPEE Light poles
7. EPEE Roof tiles
8. EPEE Weather woods for industrial purposes

#### FRP Shutters:

Our ISO 9001-2015 certified factory manufactures and supplied Fibre Glass shutters of 31/35/44mm (+/-1mm) thickness with seasoned hard wood of styles such as top rail, lock rail and bottom rail. The FRP skin is 1.5mm/2mm thick. Shutters are waterproof as well as mild acid/alkali resistant, manufactured rigorously in line with IS 4020 1998 test standards.

#### NPC Frames:

We supply GRP frames.

#### Advantages of FRP:

Wood has traditionally been the preferred material for building products; however it is a scarce resource and has led to serious environmental crises, including rapid depletion of forest cover. In the pursuit of finding suitable and superior substitutes, there has been extensive R&D for FRP (Fibre Reinforced Polymer) and GRP (Glass Reinforced Polymers). Sandwich technology used in Doors & Submarines has been found to effective for doors.



### Installation of FRP Doors

One of the many benefits of FRP Doors includes the ease of installation. This means they can be fixed in wooden, marble, masonry, Ferro cement or FRP Frames, making them the ideal choice for any type of aesthetic looks that need to be achieved.

### Sandwich Structure

FRP is made of a sandwich structure, which consists of two albeit high strength face sheets (Glass Fibre Polymers composites); bonded by liquid adhesive to a light-weight core that is Expanded Polystyrene (EPS) or Polyurethane Foam. Each component by itself is relatively weak and flexible; however, when combined in a sandwich panel, they produce a stiff, strong yet light-weight structure. Core materials serve to stabilize face sheets against buckling under compression, torsion or bending loads, providing a rigid and highly effective structure. Sandwich concept is one of the most widely accepted forms of composite structures in primary load bearing structures and their construction.



2 Panel Classic



6 Panel Colonist



Fantasy



4 Panel Estasy



6 Panel Ecstasy



Panel Sunrise



Ten Panel colonist



Panel Colonist





Panel Rectangular



Light grain Flush



Fantasy with glass and side lites



6 Panel Ecstasy Polished wood finish



Fantasy with wood finish



2 Panel rectangular with glass



French Door



Fantasy with glass and wood finish

## 5. FRP Allied Products



**FRP ALLIED PRODUCTS**

- FRP HYDRANT DOOR
- SECURITY CABIN
- ROOFTILE
- HYDRANT DOOR
- FRP GARDEN BENCH



FRP Garden Bench



Security Cabin



Rabbit Shape FRP Dust Bin



Roof Tiles



FRP Toilet



FRP Decorative trim



FRP Frame



FRP Hydrant Door



FRP Lamp post



FRP Tank



Louvers



Letter Box



FRP Dam Doors



Hydrant Door



FRP Machine covers



FRP Water Meter Cover



## BUSINESS SYSTEMS AND ORGANIZATIONS

### OUR BUSINESS PROCESS

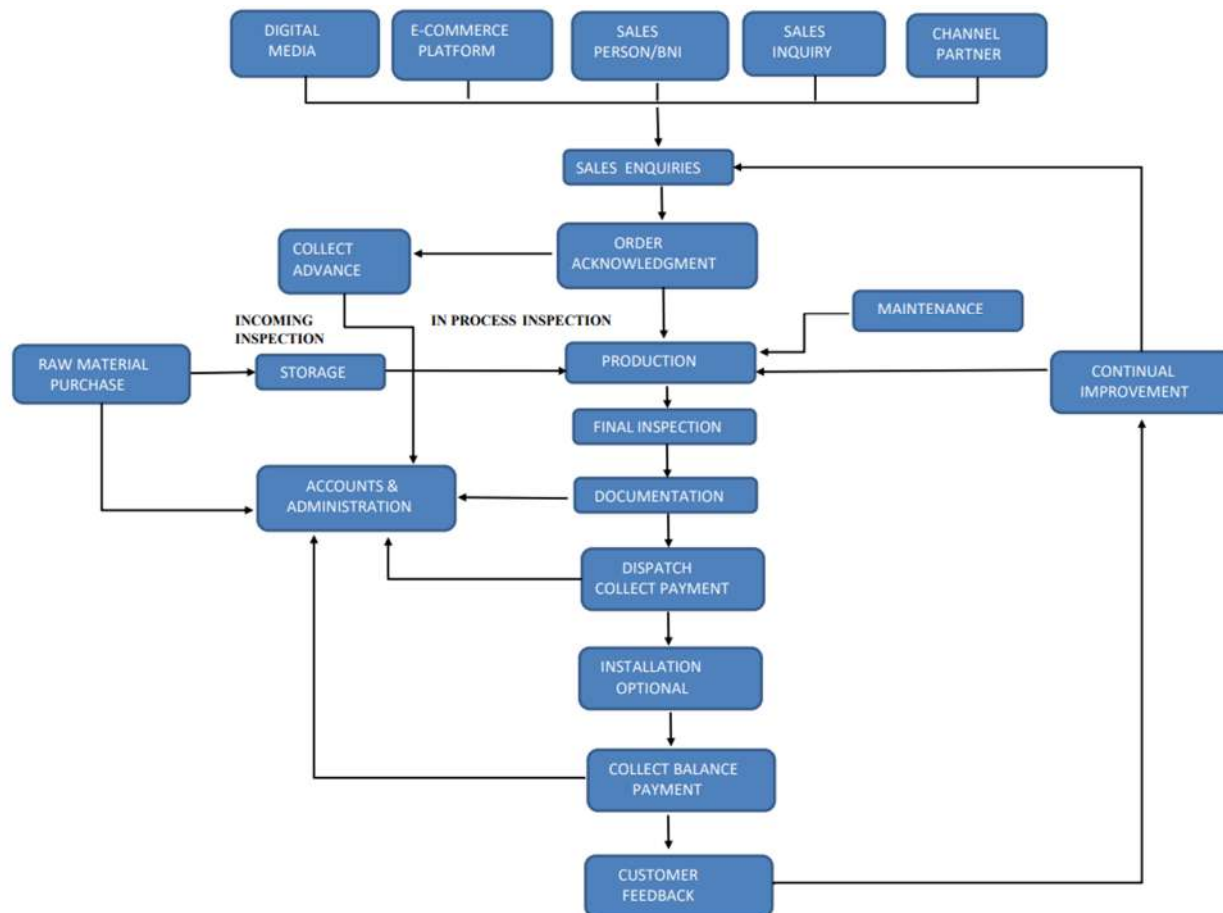

### UTILITIES

### PLANT & MACHINERY

Sr. No	Name Of The Machines	Qty
1	Hydraulic Press Machine	2 Nos
2	Circular Saw	1 No
3	Wood Cutter Machine	3 Nos
4	Oven	1 No
5	Finger Jointing Machine	1 No
6	9" Planer Stand With Avon Motor	1 No
7	Door Side Cutter	1 No
8	Twisting Machine	1 No
9	Hydraulic Material Lift	1 No
10	Hot Air Spraying Machine	1 No
11	Hammer Machines	2 Nos
12	Blowers	2 Nos
13	Grinders	3 Nos
14	Weighing Machines	2 Nos
15	CO2 Welding Machine	1 No
16	Welding Machine	6 Nos
17	Electric Mixer	1No
18	Bacteria Generating plant including chillers & compressors	1 Set

## Raw Materials

Major Raw material used in the process includes:

➤ **Glass Fibre:**

We use 450 GSM chopped Strand Matt, which acts as Reinforcement and is manufactured by Binani Glass Fibre Ltd one of the leading companies who also export their products.

➤ **Unsaturated Polyester Resin :**

This forms the binding material and provides the flexibility to the Glass Fibre Composites. This is sourced from multiple manufactures in Pune, Bangalore & Goa.

The other raw materials used are as follows:

Sr. No	Name Of The Raw Materials
1	Pigments
2	Adhesives
3	Accelerator
4	Catalyst
5	Chalk Power
6	Cowdung
7	M.S. Square Tube
8	Fibre Cement Board
9	Checkard Plate

### Water

Small quantity of Water is used in cleaning the doors once finished. Water requirement at our manufacturing facility is met through Goa Industrial Development Corporation.

### Power

Our manufacturing plant has adequate power supply position from the public supply utilities.

## CAPACITY UTILIZATION

Sr. No	Products	Units	Installed capacity	Capacity Utilized For The Years		
				F.Y 21-22	F.Y 20-21	F.Y 19-20
				( Full year)	( Full year)	(Two Months)
1	Doors	Sq.Fts		79,600.01	60,70.47	11,303.75
2	Frames	Sq. Fts		9,952.65	8,572.94	1,262.98
3	Frp Allied Products	Sq. Fts.		20,927.22	8,357.54	978.60
4	FRP Toilets	Sq. Fts.		8,832.00	5,184.00	-
5	FRP Bio Digestor Tank	Sq. Fts.		71,136.00	38,496.00	2,592.00
	<b>Total</b>		<b>2,40,000</b>	<b>1,90,447.87</b>	<b>1,21,380.95</b>	<b>16,137.32</b>
				<b>79.35%</b>	<b>50.42%</b>	<b>40.00%</b>

## OUR MAJOR CUSTOMERS

With a clientele of more than 3500 people, the organisation works with many architects, builders, consultants and extend their services to those in various sectors all over Goa which are as follows:

- Industrial sector
- Hospital sector
- Residential & Commercial Complexes

- Government institutions
- NGO Institutions
- Hospitality
- Channel Partners / Retailers

The percentage of income derived from our top customers in the last three financial years is given below

Sr. No	Particulars	FY 21-22		FY 20-21		FY 19-20	
		Revenue	Percentage (%)	Revenue	Percentage (%)	Revenue	Percentage (%)
1	Income from Top 10 Customers	555.51	68.92%	128.93	43.79%	36.13	63.59%
2	Income from Top 5 Customers (%)	530.55	65.83%	115.87	39.35%	32.89	57.89%

## COLLABORATIONS

We have not entered into any technical or financial collaboration agreements with any party.

## SEASONALITY

Our business is not seasonable in nature.

## EXPORT AND EXPORT OBLIGATIONS

The total exports of the company for fiscal year 2021-22 is Rs 3.28 lakhs. There were no exports in the fiscal year 2020-21 and 2019-20.

There are no Export Obligations as on date of this Prospectus.

## HUMAN RESOURCES

Human resource is the key element for developing a company's growth strategy and handling the day to day activities within the organization. We focus on attracting and retaining the best possible talent. Our team is a blend of experienced, professional and a strategically organized group of personnel.

As on date of this March 31, 2022, we have 30 employees on our payroll, which look after the day to day business operations, administrative, secretarial, legal and accounting functions in accordance with their respective designated duties.

Sr. No	Category	Number of employees
1.	Executive Director	2
2.	Key Managerial Personnel (KMP)	2
3.	Other Employees	26
	<b>Total</b>	<b>30</b>

## QUALITY MANUAL

Company has established the Quality management system in accordance with the requirements of ISO 9001: 2015. Company has considered the legal and regulatory requirements during the establishment of the system. The system is documented in Quality manual and related documents at various levels. The resources and the information required for the processes and methods needed to control and carryout the processes are also determined in the respective documents. The organization also determined the controls to monitor, analyze and improve the process continually to achieve the planned objectives. Wherever the processes are outsourced, company identifies and implements suitable control over such processes within Quality Management System.

### *Process Approach:*

Company identifies and implements suitable control over each process with process approach of:

- Define the inputs specific to that process along with measurable objectives.
- Installed control on pre-defined inputs like Competent Person, Maintained Resources, Documented Information, Controlled Monitoring & Measuring Resources and Obligation compliance.
- Perform controlled activity as per set procedure and methods.
- Target the desired output conformance and target continual improvement.
- In case of Non-conforming outputs situation, resolve them as per risk management methods and corrective actions.

One process output is an input for the next process steps and company works with a motto of “Satisfy the Internal Customer First” approach.

**PDCA CYCLE:**

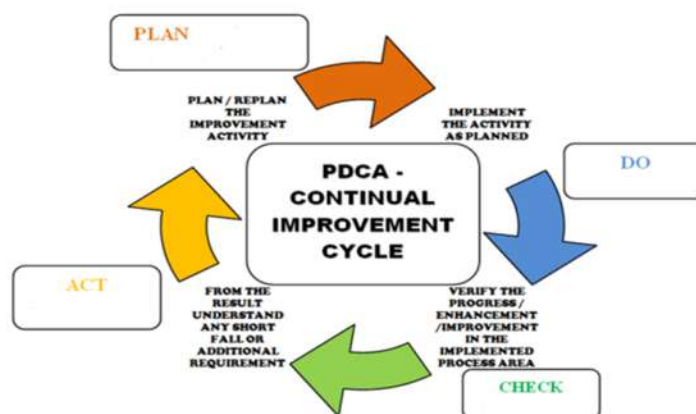

**COMPETITION**

We face competition from various domestic and other players in the market. Most of our competitors in the regional level are from the unorganized sector of the industry. We intend to continue competing vigorously to capture more market share and manage our growth in an optimal way. We expect that our commitment to quality, past record of timely execution and transparency will provide us with an edge over our competitors. Further we believe that our competition also depends on several factors which include changing business framework, competitive price, and established relationship with suppliers, brand recognition etc. We are one of the few companies manufacturing FRP Doors and Bio Digester Tanks in the Organized Sector. With the introduction of GST, unorganized market is shrinking at faster rate than before and organized companies like ours can expand rapidly in collaboration with local entrepreneurs in other areas. The focus will be on expanding to the huge untapped markets in India and abroad as substantial part of the funds will be utilized to strengthen this aspect. We therefore believe that we will be able to grow healthily despite competition.

**PROPERTIES**

**Rented Property**

The registered office and manufacturing unit of our company is located at Plot No 57, Shed No D-2/12, Bicholim Industrial Estate, Bicholim, Goa, 403504 which is provided by our Promoter. We have been using the mentioned premises since incorporation. However, the same was not formalised and the company had obtained NOC for operating from the mentioned premises. Hence in order to formalise such arrangement, we have entered into a sub leasing agreement dated August 13, 2021 for the land as well as building of manufacturing facility by paying one time refundable security deposit. For further details, please refer chapter “Objects of the Issue ‘on page no. 56 of this Prospectus.

Sr. No.	Name of the Licensor	Name of the Licensee	Details of the Property	Sub Lease Charges and Security Deposit	Purpose
1.	M/s Om Ventures	EP Biocomposites Limited	No 57, Shed No D-2/12, Bicholim Industrial Estate,	License Fee: ₹ 1.50 lakhs p.m.*	Registered office and Manufacturing

Sr. No.	Name of the Licensor	Name of the Licensee	Details of the Property	Sub Lease Charges and Security Deposit	Purpose
			Bicholim, Goa-	<b>Deposit:</b> ₹200 .00 lakhs	Unit
2.	Shri. Rashmi Narandas Kotecha	EP Biocomposites Limited	1 <sup>st</sup> Floor, B.R. Commercial Centre, Opp. Parade Ground, Campal, Panaji, Goa-403001	<b>License Fee:</b> ₹0.85 lakhs p.m. <b>Deposit:</b> ₹5.10 lakhs	Corporate Office

*\*Upon the payment of the entire security deposit, the sub lease charges shall be reduced to Rs 20,000 for the rest of the duration of the sub lease.*

## INTELLECTUAL PROPERTY

We have following trademark registered in our company's name for our business operations.

Sr. No.	Particulars of Intellectual Property	Mark Type	Status	Valid Upto	Application No.	Class
1.		Device	Registered	June 17, 2030	4533722	11

The following Trademark is registered in the name of our promoter - Mr Rajkumar Kamat\*

Sr. No.	Particulars of Intellectual Property	Mark Type	Status	Valid Upto	Application No.	Class
1.		Device	Registered	November 21, 2025	1400439	20

*\*Mr. Rajkumar Kamat has accorded permission to the Company for making use of the said trademark via a No Objection Certificate (NOC). For further details, please refer to risk factor no. 12 appearing on page no. 19 of the section titled "Risk Factors" of this Prospectus.*

## Certificates/Licenses Obtained

Accreditation/ Certifications	Issuing authority	Certificate No	Validity period	Description
ISO 9001:2015	Paramount Quality Certifications	836/Q/210320	21.03.2020 to 20.03.2023	Manufacturing and supply of fibre reinforced polymer FRP products such as door shutters, Frames, Biodigester tanks, bio toilets besides bacteria inoculums and allied products for construction and industrial applications.

## INSURANCE

We have taken sufficient insurance to cover different risks which we believe is sufficient to cover all material risks to our operations and revenue. Our operations are subject to hazards inherent to the safe keeping of a physical inventory, such as risks relating to work accidents, fire, earthquake, burglary and transit. This includes hazards that may cause injury and loss of life, damage and destruction of property and equipment. Our Company has obtained standard fire and special perils policy.

## KEY INDUSTRY REGULATIONS AND POLICIES

*In carrying on our business as described in the section titled “Our Business” on page no.72 of this Prospectus, our Company is regulated by the following legislations in India. The following description is a summary of the relevant regulations and policies as prescribed by the Government of India and other regulatory bodies that are applicable to our business. The information detailed in this Chapter has been obtained from the various legislations, including rules and regulations promulgated by the regulatory bodies and the bye laws of the respective local authorities that are available in the public domain. The regulations and policies set out below may not be exhaustive and are only intended to provide general information to the investors and are neither designed nor intended to be a substitute for professional legal advice. For details of Government Approvals obtained by the Company in compliance with these regulations, kindly refer to the Chapter titled “Government and Other Key Approvals” beginning on page no. 157 of this Prospectus.*

### A. **INDUSTRY RELATED LEGISLATIONS:**

#### **The Factories Act, 1948("Factories Act")**

The Factories Act seeks to regulate labour employed in factories and makes provisions for the safety, health and welfare of the workers. An occupier of a factory under the Factories Act, means the person who has ultimate control over the affairs of the factory. The occupier or manager of the factory is required to obtain a registration for the factory. The Factories Act also requires inter alia the maintenance of various registers dealing with safety, labour standards, holidays and extent of child labour including their conditions. Further, notice of accident or dangerous occurrence in the factory is to be provided to the inspector by the manager of the factory.

The Goa Factories Rules, 1985 is also applicable to our Company.

#### **Goa Shops and Establishment Act, 1973**

The Goa Shops & Establishments Act and Rules are applicable to all the shops and commercial establishments in the areas notified by Government of Goa.

The Act is enacted for the purpose of protecting the rights of employees. The Act provides regulations of the payment of wages, terms of services, work hours, rest intervals, overtime work, opening and closing hours, closed days, holidays, leaves, maternity leave and benefits, work conditions, rules for employment of children, records maintenance, etc.

#### **The Employees State Insurance Act, 1948 (“ESI Act”)**

The Employees State Insurance Act, 1948 provides for certain benefits to employees in case of sickness, maternity and employment injury. All employees in establishments covered by the ESI Act are required to be insured, with an obligation imposed on the employer to make certain contributions in relation thereto. Employers of factories and establishments covered under the ESI Act are required to pay contributions to the Employees State Insurance Corporation, in respect of each employee at the rate prescribed by the Central Government. Companies which are controlled by the Government are exempt from this requirement if employees receive benefits similar or superior to the benefits prescribed under the ESI Act. In addition, the employer is also required to register itself under the ESI Act and maintain prescribed records and registers.

#### **The Micro, Small and Medium Enterprises Development Act, 2006 and Industries (Development and Regulation) Act, 1951(“MSMED Act”)**

In order to promote and enhance the competitiveness of Micro, Small and Medium Enterprise (MSME) the Micro, Small and Medium Enterprises Development Act, 2006 is enacted. A National Board shall be appointed and established by the Central Government for MSME enterprise with its head office at Delhi in the case of the enterprises engaged in the manufacture or production of goods pertaining to any industry mentioned in first schedule to Industries (Development and Regulation) Act, 1951. The Central Government has vide its notification numbering 1702(E) dated June 1, 2020 amended the definition of MSME which has come into effect from July 1, 2020. The revised definition is as under: i. a micro enterprise, where the investment in Plant and Machinery or Equipment does not exceed one Crore rupees and turnover does not exceed five Crore rupees; ii. a small enterprise, where the investment in Plant and Machinery or Equipment does not exceed ten Crore rupees and turnover does not exceed fifty Crore rupees; and iii. a medium enterprise, where the investment in Plant and



Machinery or Equipment does not exceed fifty Crore rupees and turnover does not exceed two hundred and fifty Crore rupees. The MSMED Act provides for the memorandum of micro, small and medium enterprises to be submitted by the relevant enterprises to the prescribed authority. The MSMED Act also provides for the establishment of the Micro and Small Enterprises Facilitation Council ('Council'). The Council has jurisdiction to act as an arbitrator or conciliator in a dispute between the supplier located within its jurisdiction and a buyer located anywhere in India.

## **B. LABOUR RELATED REGULATIONS:**

Certain other laws and regulations that may be applicable to us in India include the following:

- Employee State Insurance Act, 1948;
- Employees Provident Fund and Miscellaneous Provisions Act, 1952
- Child Labour (Prohibition and Regulation) Act, 1986
- Employees' Compensation Act, 1923;
- Equal Remuneration Act, 1976;
- Inter-State Migrant Workmen (Regulation of Employment and Conditions of Service) Act, 1979;
- Maternity Benefit Act, 1961;
- Minimum Wages Act, 1948;
- Payment of Wages Act, 1936;
- Sexual Harassment of Women at Workplace (Prevention, Prohibition and Redressal) Act, 2013;
- The Payment of Bonus Act, 1965; and
- Payment of Gratuity Act, 1972.
- The Code on Wages, 2019\*;
- The Occupational Safety, Health and Working Conditions Code, 2020\*\*;
- The Industrial Relations Code, 2020\*\*\*;
- The Code on Social Security, 2020\*\*\*\*; and
- Industrial Employment (Standing Order), Act, 1946.

*\*The Government of India enacted 'The Code on Wages, 2019' which received the assent of the President of India on August 8, 2019. It proposes to subsume four separate legislations, namely, the Payment of Wages Act, 1936, the Minimum Wages Act, 1948, the Payment of Bonus Act, 1965 and the Equal Remuneration Act, 1976. Certain provisions of this code pertaining to central advisory board, have been brought into force by the Ministry of Labour and Employment through a notification dated December 18, 2020 and other provisions of this code will be brought into force on a date to be notified by the Central Government.*

*\*\*The Government of India enacted 'The Occupational Safety, Health and Working Conditions Code, 2020' which received the assent of the President of India on September 28, 2020. The provisions of this code have not yet been brought into force. It proposes to subsume several separate legislations, including the Factories Act, 1948, the Contract Labour (Regulation and Abolition) Act, 1970, the Inter-State Migrant Workmen (Regulation of Employment and Conditions of Service) Act, 1979 and the Building and Other Construction Workers (Regulation of Employment and Conditions of Service) Act, 1996.*

*\*\*\*The Government of India enacted 'The Industrial Relations Code, 2020' which received the assent of the President of India on September 28, 2020. The provisions of this code have not yet been brought into force. It proposes to subsume three separate legislations, namely, the Industrial Disputes Act, 1947, the Trade Unions Act, 1926 and the Industrial Employment (Standing Orders) Act, 1946.*

*\*\*\*\*The Government of India enacted 'The Code on Social Security, 2020' which received the assent of the President of India on September 28, 2020. It proposes to subsume several separate legislations including the Employee's Compensation Act, 1923, the Employees' State Insurance Act, 1948, the Employees' Provident Funds and Miscellaneous Provisions Act, 1952, the Maternity Benefit Act, 1961, the Payment of Gratuity Act, 1972, the Building and Other Construction Workers' Welfare Cess Act, 1996 and the Unorganised Workers' Social Security Act, 2008. Section 142 of the Code on Social Security, 2020 has been brought into force from May 3, 2021 by the Ministry of Labour and Employment through a notification dated April 30, 2021 and other provisions of this code will be brought into force on a date to be notified by the Central Government.*

## C. ENVIRONMENTAL REGULATIONS:

### **Environmental regulations**

We are subject to various environmental regulations as the operation of our establishments might have an impact on the environment. The basic purpose of such statutes is to control, abate and prevent pollution. In order to achieve these objectives, Pollution Control Boards (“PCBs”), have been set up in each state and at a central level. Establishments, as prescribed under various regulations may be required to obtain consent orders from the PCBs. These consent orders are required to be renewed periodically.

### **Environment Protection Act, 1986 (“EPA”)**

The EPA has been enacted with the objective of protecting and improving the environment and for matters connected therewith. As per the EPA, the Central Government has been given the power to take all such measures for the purpose of protecting and improving the quality of the environment and to prevent, control and abate environmental pollution. Further, the Central Government has been given the power to give directions in writing to any person or officer or any authority for any of the purposes of the EPA, including the power to direct the closure, prohibition or regulation of any industry, operation or process. Further, the Environment (Protection) Act, 1986 provides for, *inter alia*, standards for emissions or discharge of environmental pollutants, prohibitions and restrictions on the location of industries and the carrying on processes and operations in different areas, procedure for submission of samples for analysis and functions of environmental laboratories.

### **Air (Prevention and Control of Pollution) Act, 1981 (“Air Act”)**

The Air Act requires that any industrial plant emitting any air pollutant into the atmosphere must apply in a prescribed form and obtain consent from the state PCB prior to commencing any activity. The state PCB is required to grant, or refuse, consent within four months of receipt of the application. The consent may contain conditions relating to specifications of pollution control equipment to be installed.

### **Water (Prevention and Control of Pollution) Act, 1974 (“Water Act”)**

The Water Act prohibits the use of any stream or well or land for the disposal of any poisonous, noxious or polluting matter, in violation of the standards set out by the concerned PCB. The Water Act also provides that the consent of the concerned PCB must be obtained prior to opening of, *inter-alia*, any industry, operation or process, which is likely to discharge sewage or trade effluent.

### **Hazardous and Other Wastes (Management and Transboundary Movement) Rules, 2016 (“Hazardous Waste Rules”)**

An “occupier” has been defined as any person who has control over the affairs of a factory or premises or any person in possession of hazardous or other waste. In terms of the Hazardous Waste Rules, occupiers have been, *inter alia*, made responsible for safe and environmentally sound handling of hazardous and other wastes generated in their establishments and are required to obtain license/ authorization from concerned PCBs, for handling, generating, collecting, processing, treating, packaging, storing, transporting, using, recycling, recovering, pre-processing, co-processing, offering for sale, or the like of the hazardous and other wastes.

## D. TAX RELATED LEGISLATIONS:

### **Income-tax Act, 1961**

Income-tax Act, 1961 (“IT Act”) is applicable to every company, whether domestic or foreign whose income is taxable under the provisions of this Act or Rules made there under depending upon its ‘Residential Status’ and ‘Type of Income’ involved. Every assessee, under the IT Act, which includes a company, is required to comply with the provisions thereof, including those relating to tax deduction at source, advance tax, minimum alternative tax and like.

### **Professional Tax**

The professional tax slabs in India are applicable to those citizens of India who are either involved in any profession or trade. The State Government of each State is empowered with the responsibility of structuring as

well as formulating the respective professional tax criteria and is also required to collect funds through professional tax. The professional taxes are charged on the incomes of individuals, profits of business or gains in vocations. The professional tax is charged as per the List II of the Constitution. The professional taxes are classified under various tax slabs in India. The tax payable under the State Acts by any person earning a salary or wage shall be deducted by his employer from the salary or wages payable to such person before such salary or wages is paid to him, and such employer shall, irrespective of whether such deduction has been made or not when the salary and wage is paid to such persons, be liable to pay tax on behalf of such person and employer has to obtain the registration from the assessing authority in the prescribed manner. Every person liable to pay tax under these Acts (other than a person earning salary or wages, in respect of whom the tax is payable by the employer), shall obtain a certificate of enrolment from the assessing authority.

### **Central Goods and Services Tax Act, 2017**

The Central Goods and Services Tax Act, 2017 (“**CGST Act**”) regulates the levy and collection of tax on the intra- State supply of goods and services by the Central Government or State Governments. The CGST Act amalgamates a large number of Central and State taxes into a single tax. The CGST Act mandates every supplier providing the goods or services to be registered within the State or Union Territory it falls under, within 30 days from the day on which he becomes liable for such registration. Such registrations can be amended, as well as cancelled by the proper office on receipt of application by the registered person or his legal heirs. There would be four tax rates namely 5%, 12%, 18% and 28%. The rates of GST applied are subject to variations based on the goods or services.

### **Integrated Goods and Services Tax Act, 2017**

Integrated Goods and Services Tax Act, 2017 (“**IGST Act**”) is a Central Act enacted to levy tax on the supply of any goods and/ or services in the course of inter-State trade or commerce. IGST is levied and collected by Centre on interstate supplies. The IGST Act sets out the rules for determination of the place of supply of goods. Where the supply involves movement of goods, the place of supply shall be the location of goods at the time at which the movement of goods terminates for delivery to the recipient. The IGST Act also provides for determination of place of supply of service where both supplier and recipient are located in India or where supplier or recipient is located outside India. The provisions relating to assessment, audit, valuation, time of supply, invoice, accounts, records, adjudication, appeal etc. given under the CGST Act are applicable to IGST Act.

Further, the Company is also governed by various State Goods and Service Tax statutes for levy and collection of tax on intra-State supply of goods and services or both which are as follows:

- *Goa Goods and Service Tax Act, 2017.*

## **E. OTHER LEGISLATIONS:**

### **Transfer of Property Act, 1882(“T.P. Act.”)**

The transfer of property, including immovable property, between living persons, as opposed to the transfer property by operation of law, is governed by the T.P. Act. The T.P. Act establishes the general principles relating to the transfer of property, including among other things, identifying the categories of property that are capable of being transferred, the persons competent to transfer property, the validity of restrictions and conditions imposed on the transfer and the creation of contingent and vested interest in the property. Transfer of property is subject to stamping and registration under the specific statutes enacted for the purposes which have been dealt with hereinafter.

The T.P. Act recognizes, among others, the following forms in which an interest in an immovable property may be transferred:

- Sale: The transfer of ownership in property for a price paid or promised to be paid.
- Mortgage: The transfer of an interest in property for the purpose of securing the payment of a loan, existing or future debt, or performance of an engagement which gives rise to a pecuniary liability. The T.P. Act recognizes several forms of mortgages over a property.
- Charges: Transactions including the creation of security over property for payment of money to another which are not classifiable as a mortgage. Charges can be created either by operation of law, e.g. decree of the court attaching to specified immovable property, or by an act of the parties.

- Leases: The transfer of a right to enjoy property for consideration paid or rendered periodically or on specified occasions.
- Leave and License: The transfer of a right to do something upon immovable property without creating interest in the property.

Further, it may be noted that with regards to the transfer of any interest in a property, the transferor transfers such interest, including any incidents, in the property which he is capable of passing and under the law, he cannot transfer a better title than he himself possesses.

### **The Registration Act, 1908 (“Registration Act”)**

The Registration Act was passed to consolidate the enactments relating to the registration of documents. The main purpose for which the Registration Act was designed was to ensure information about all deals concerning land so that correct land records could be maintained. The Registration Act is used for proper recording of transactions relating to other immovable property also. The Registration Act provides for registration of other documents also, which can give these documents more authenticity. Registering authorities have been provided in all the districts for this purpose.

### **The Indian Contract Act, 1872 (“Contract Act”)**

The Indian Contract Act codifies the way in which a contract may be entered into, executed, implementation of the provisions of a contract and effects of breach of a contract. A person is free to contract on any terms he chooses. The Contract Act consists of limiting factors subject to which contract may be entered into, executed and the breach enforced. It provides a framework of rules and regulations that govern formation and performance of contract. The contracting parties themselves decide the rights and duties of parties and terms of agreement.

### **The Specific Relief Act, 1963 (“Specific Relief Act”)**

The Specific Relief Act is complimentary to the provisions of the Contract Act and the Transfer of Property Act, as the Act applies both to movable property and immovable property. The Specific Relief Act applies in cases where the Court can order specific performance of a contract. Specific relief can be granted only for purpose of enforcing individual civil rights and not for the mere purpose of enforcing a civil law. ‘Specific performance’ means Court will order the party to perform his part of agreement, instead of imposing on him any monetary liability to pay damages to other party.

The Competition Act aims to prevent anti-competitive practices that cause or are likely to cause an appreciable adverse effect on competition in the relevant market in India. The Competition Act regulates anti-competitive agreements, abuse of dominant position and combinations. The Competition Commission of India (“**Competition Commission**”) which became operational from May 20, 2009 has been established under the Competition Act to deal with inquiries relating to anti-competitive agreements and abuse of dominant position and regulate combinations. The Competition Act also provides that the Competition Commission has the jurisdiction to inquire into and pass orders in relation to an anti-competitive agreement, abuse of dominant position or a combination, which even though entered into, arising or taking place outside India or signed between one or more non-Indian parties, but causes an appreciable adverse effect in the relevant market in India.

### **The Companies Act, 2013 (the “Companies Act”)**

The Companies Act, *inter alia*, regulates the incorporation of companies, prescribes the roles and responsibilities of directors, shareholders and key managerial personnel and the procedure for undertaking various corporate actions by the company. Declaration of dividends by companies is regulated, among other sections, under Section 123 of the Companies Act. One of the conditions stated therein is that dividend can be declared by a company out of profits for the year or out of profits for the previous financial year, subject to compliance with the specified conditions, or out of money provided by the state or central government for the payment of dividend by the company. Also, dividend can be declared and paid only from the free reserves of the company. Similarly, a number of restrictions and conditions are set out in Section 68 of the Companies Act for undertaking a buy back by companies. For instance, a buy-back can be conducted by a company only from its free reserves, securities premium account or from proceeds of the Issue of any shares or other specified securities subject to compliance with specified conditions. Further, a company is not permitted to undertake a buy-back of more than twenty five per cent of the aggregate of paid-up capital and free reserves of the company in a particular financial year and no

offer or buy-back can be made within a period of one year from the date of closure of the preceding offer or buy-back, if any.

We are also required to comply with the Competition Act, 2002, as amended (“**Competition Act**”), which regulates practices having an appreciable adverse effect on competition in the relevant market in India and combinations (including mergers, amalgamations and acquisitions) in excess of certain thresholds.

#### **The Trademarks Act, 1999 (“Trademarks Act”)**

Under the Trademarks Act, a trademark is a mark capable of being represented graphically and which is capable of distinguishing the goods or services of one person from those of others used in relation to goods and services to indicate a connection in the course of trade between the goods and some person having the right as proprietor to use the mark. A ‘mark’ may consist of a device, brand, heading, label, ticket, name signature, word, letter, numeral, shape of goods, packaging or combination of colors or any combination thereof. Section 18 of the Trademarks Act requires that any person claiming to be the proprietor of a trade mark used or proposed to be used by him, must apply for registration in writing to the registrar of trademarks. The trademark, once applied for and which is accepted by the Registrar of Trademarks (“**the Registrar**”), is to be advertised in the trademarks journal by the Registrar. Oppositions, if any, are invited and, after satisfactory adjudications of the same, a certificate of registration is issued by the Registrar. The right to use the mark can be exercised either by the registered proprietor or a registered user. The present term of registration of a trademark is 10 (ten) years, which may be renewed for similar periods on payment of a prescribed renewal fee.

#### **F. REGULATIONS REGARDING FOREIGN INVESTMENT**

Foreign investment in India is governed by the applicable provisions of Foreign Exchange Management Act, 1999 (“**the FEMA**”) along with the provisions of Foreign Exchange Management (Non-Debt Instruments Rules), 2019, as amended (“**Non-Debt Instrument Rules**”) as well as the FDI Policy, defined below, issued by the Department for Promotion of Industry and Internal Trade (“**DPIIT**”), from time to time. Further, the RBI has enacted the Foreign Exchange Management (Mode of Payment and Reporting of Non-Debt Instruments) Regulations, 2019 which regulate the mode of payment and reporting requirements for investments in India by a person resident outside India.

The DPIIT, Ministry of Commerce and Industry has issued ‘Consolidated FDI Policy Circular of 2020’ (“**FDI Policy**”) which consolidates the policy framework on Foreign Direct Investment (“**FDI**”), with effect from October 15, 2010. The FDI Circular consolidates and subsumes all the press notes, press releases, and clarifications on FDI issued by DIPP till October 15, 2020.

The foreign investment in our Company is governed *inter alia* by the FEMA, as amended, Non-Debt Instrument Rules, as amended, the FDI Policy issued and amended by way of press notes, and the SEBI FPI Regulations.

Currently, 100% FDI is permitted under the automatic route subject to compliance with relevant regulations.



## HISTORY AND CERTAIN CORPORATE MATTERS

Our Company was incorporated as EP Biocomposites Limited on January 17, 2020 under the Companies Act, 2013 with the Registrar of Companies, Goa bearing Registration number 014240. Further, pursuant to Business Takeover Agreement dated August 31, 2021, our Company acquired the business of M/s. OM Ventures, a proprietorship concern of one of our Promoter Leena Kamat. The Corporate Identification Number of our Company is U28900GA2020PLC014240. Our Company is managed by our Promoter Directors Rajkumar Kamat. For further details, see “Our Promoter and Promoter Group” and “Our Management” on page nos. 113 and 101 respectively of this Prospectus.

Our Company has Seven (7) shareholders as on the date of filing of this Prospectus.

### OVERVIEW

Our company was incorporated on 17 January 2020 and is into manufacturing and supply of fibre re-inforced polymers (FRP) products such as door shutters, frames, Biodigester Tanks, Bio toilets besides Bacteria Inoculum & allied products for construction and Industrial applications which meets customer requirements The company has taken over the running business of our promoter, ‘Om Ventures’, a sole proprietorship through a business transfer agreement dated August 31, 2021. For further details please refer to “History and other corporate matters” beginning on page no. 98 of this Prospectus.

We focus on giving sanitation solutions to those who do not have access to toilets, as well as to those who have toilets but face trouble treating and managing the waste. We provide sanitation infrastructure and human waste management solutions and services, involving innovative and simple bio-digester technology licensed from Defence Research and Development Organisation (DRDO) and Industry Interface and Technology Management, operating under the aegis of DRDO, Ministry of Defence, and Government of India. The anaerobic bio-digester technology helps users manage waste onsite, without depending on expensive and energy-consuming sewage infrastructure. The Sewage Treatment Plant helps contaminant concentrations to be lowered to a safe level before wastewater can be reused or returned to the environment. The effluent water treatment - a technique used for processing industrial wastewater for reuse or safe discharge to the environment. The company also specializes in FRP allied products. FRP which stands for Fiber Reinforced Polymer is an eco-friendly substitute for wood that has long been the chosen building material - a limited resource that has resulted in major environmental problems, such as fast forest decline.

The company has supplied more than 2,00,000 FRP doors thereby saving more than thousands of trees and 2500 Bio Toilets to household helping reduction to open defecation thereby contributing to clean and green surroundings. For our innovation and continuous contribution for betterment of society, we as a group have been recognized and acclaimed with the National Award for Outstanding Efforts in Entrepreneurship in MSEs (Manufacturing)

Our revenue from operations was Rs 805.96, Rs 294.80 lakhs and Rs 56.81 lakhs for Fiscal 2022, 2021 and 2020 respectively. It may be noted that, despite pandemic the company has been growing exponentially

Our EBITDA was Rs 116.60, Rs 46.42 lakhs and Rs 4.31 lakhs for Fiscal 2022, 2021 and 2020 respectively. Our restated profit after tax was Rs 80.94, Rs 35.80 lakhs and Rs 3.15 lakhs for Fiscal 2022, 2021 and 2020 respectively.

### MAJOR EVENTS IN THE HISTORY OF OUR COMPANY

Month & Year	Key Events/Milestones/Achievements
January, 2020	Incorporation of Company
August, 2021	Takeover of Proprietorship Concern pursuant to Business Takeover Agreement dated August 31, 2021

### MAIN OBJECTS OF OUR COMPANY

1. To carry on the business of Manufacturing, Designing, Developing, Selling, Importing, Dealing, Exporting, products such as WPC, GRP, FRP Doors, Frames, Bio Digester Tanks, Toilets, and other Allied products and manufacture of MS gates, Grills, railings, and other Architectural products and manufacture of Fire Retardant doors and passive Fire protection Systems with accessories and other allied products.
2. To manufacture, sell, export, all kinds of composites, Fiber Reinforced Polymer products and also to develop, manufacture, provides, undertake, design, import, export, distribute and deal with waste Management Solutions besides



fire safety and prevention products and Exquisite product to Beautify and protect Homes and Workplaces while contributing towards a Clean, Green and Safe Surrounding

3. To carry on business of manufacturing, buying, selling, importing, exporting, and dealing in Green Technology & Waste Management products, environment friendly machines, equipment's, patterns, products and services including such products & services which are concerning saving the earth's resources and to manufacture, import, export and otherwise deal in coated paper, and other coated products.

4. To buy import, export, sell and generally deal in all implements, accessories, tools, goods or things and all related for main objects.

#### **CHANGES IN THE REGISTERED OFFICE OF OUR COMPANY**

There has been no change in the Registered Office of our Company since Incorporation till the date of this Prospectus

#### **AMENDMENTS TO THE MEMORANDUM OF ASSOCIATION OF OUR COMPANY SINCE INCORPORATION**

The following changes have been made to the Memorandum of Association of our Company:

<b>Sr. No.</b>	<b>Date of Shareholder's Resolution</b>	<b>Nature of Amendment</b>
1.	July 7, 2021	The initial Authorized Share Capital of ₹ 15,00,000 (Rupees Fifteen Lakh) divided into 1,50,000 (One Lakh Fifty Thousand) Equity Shares of ₹ 10 each was increased to ₹ 2,00,00,000 (Rupees Two Crores) divided into 20,00,000 (Twenty Lakh) Equity Shares of ₹ 10 each pursuant to Shareholders Resolution passed at the Annual General Meeting held on July 7, 2021.

#### **OUR HOLDING COMPANY**

As on the date of this Prospectus, our Company does not have any Holding Company.

#### **OUR SUBSIDIARIES / JOINT VENTURE**

As on the date of this Prospectus, there are no subsidiaries of our Company.

#### **THE AMOUNT OF ACCUMULATED PROFIT / (LOSSES) NOT ACCOUNTED FOR BY OUR COMPANY**

There is no accumulated profit / (losses) not accounted for by our Company.

#### **FINANCIAL PARTNERS**

We do not have any financial partners as on the date of this Prospectus.

#### **STRATEGIC PARTNERS**

We do not have any strategic partners as on the date of this Prospectus.

#### **SHAREHOLDERS' AGREEMENT**

Our Company has not entered into any Shareholders Agreement as on the date of this Prospectus.

#### **OTHER AGREEMENTS**

Except the contracts / agreements entered in the ordinary course of the business carried on or intended to be carried on by our Company, we have not entered into any other agreement / contract as on the date of this Prospectus.

#### **COLLABORATION**

Our Company has not entered into any Collaboration as on the date of this Prospectus.

## **ACQUISITION OF BUSINESSES/UNDERTAKINGS, MERGER, AMALGAMATION OR REVALUATION OF ASSETS IN LAST 10 YEARS**

Our business was originally being run as a proprietorship named M/s. OM Ventures. Further, our company is incorporated on January 17, 2020, as a public limited company under the name 'EP Biocomposites Limited' under the provisions of the Companies Act, 2013 with the Registrar of Companies, Goa with a vision to corporatize our business. Further, pursuant to Business Takeover Agreement dated August 31, 2021, our Company acquired the business of M/s. OM Ventures, a proprietorship concern of one of our Promoter Leena Kamat.

## **LAUNCH OF KEY PRODUCTS OR SERVICES, ENTRY INTO NEW GEOGRAPHIES OR EXIT FROM EXISTING MARKETS, CAPACITY/ FACILITY CREATION OR LOCATION OF PLANTS**

For details of key products or services launched by our Company, entry into new geographies or exit from existing markets, capacity/facility creation, and location of our manufacturing facilities, see "*Our Business*" on page 72 of this Prospectus.

## **TIME/COST OVERRUN IN SETTING UP PROJECTS**

As on date of this Prospectus, there has been no time and cost overruns in the Company.

## **LOCK-OUT AND STRIKES**

There have been no instances of strikes or lock-outs at any time in our Company.

## **DEFAULTS OR RESCHEDULING OF BORROWINGS WITH FINANCIAL INSTITUTIONS/ BANKS**

As on date of this Prospectus, our Company has not made any defaults / re-scheduling of its borrowings.

## **INJUNCTION OR RESTRAINING ORDERS**

There are no injunctions/restraining orders that have been passed against the company.

## OUR MANAGEMENT

### BOARD OF DIRECTORS

As on the date of this Prospectus, our Board consists of Five (5) Directors including One (1) as Managing Director, One (1) as Executive Director, One (1) as Non-Executive Director and Two (2) are Non-Executive Independent Directors. Further, we have one (1) Women Director on our Board

The details of the Directors are as mentioned in the below table:

Sr. No.	Name , Designation, Address, Date of Birth, Occupation, Term and DIN	Nationality	Age	Other Directorships
1.	<p><b>Rajkumar Kamat</b></p> <p><b>Designation:</b> Chairperson &amp; Managing Director</p> <p><b>Date of Birth:</b> October 22, 1959</p> <p><b>Address:</b> H. No-323 Sneh, Vodlem Bhat, Taleigao, Tiswadi, Caranzalem, North Goa, Tiswadi, Goa-403002</p> <p><b>Date of Appointment as Director:</b> January 17, 2020</p> <p><b>Date of Appointment as Managing Director:</b> 28/04/2020</p> <p><b>Term:</b> Appointed as Managing Director for a period of five years i.e. till April 27, 2025</p> <p><b>Occupation:</b> Business</p> <p><b>DIN:</b> 01157652</p>	Indian	62 years	<ul style="list-style-type: none"> <li>Epee Metal Goa Private Limited</li> <li>Epee Bio Solutions Private Limited</li> </ul>
2.	<p><b>Shreyas Nadkarni</b></p> <p><b>Designation:</b> Executive Director</p> <p><b>Date of Birth:</b> September 21, 1986</p> <p><b>Address:</b> C-27, Sunil Apartments, Kastur Park Shimpoli Road, Borivali (West) Mumbai-400092</p> <p><b>Date of Appointment as Additional Director:</b> January 7, 2022</p> <p><b>Date of Appointment as Non-Executive Director:</b> June 10, 2022</p> <p><b>Term:</b> Shall be liable to retire by rotation</p> <p><b>Occupation:</b> Business</p> <p><b>DIN:</b> 09396530</p>	Indian	36 years	Nil

Sr. No.	Name , Designation, Address, Date of Birth, Occupation, Term and DIN	Nationality	Age	Other Directorships
3.	<p><b>Leena Kamat</b></p> <p><b>Designation:</b> Non-Executive Director</p> <p><b>Date of Birth:</b> September 14, 1965</p> <p><b>Address:</b> H. No-323 Sneh, Vodlem Bhat, Taleigao, Tiswadi, Caranzalem, North Goa, Tiswadi, Goa-403002</p> <p><b>Date of Appointment as Non-Executive Director:</b> January 17, 2020</p> <p><b>Term:</b> Shall be liable to retire by rotation</p> <p><b>Occupation:</b> Business</p> <p><b>DIN:</b> 02607730</p>	Indian	56 years	<ul style="list-style-type: none"> <li>• Epee Metal Goa Private Limited</li> <li>• Epee Bio Solutions Private Limited</li> </ul>
4.	<p><b>Nitin Kunkolienker</b></p> <p><b>Designation:</b> Non-Executive Independent Director</p> <p><b>Date of Birth:</b> April 14, 1968</p> <p><b>Address:</b> Plot No. 25, Sagar society- Donapaula, Caranzalem S.O North Goa- 403002</p> <p><b>Date of Appointment as Additional Independent Director:</b> April 28, 2020</p> <p><b>Date of Appointment as Non-Executive Independent Director:</b> December 15, 2020</p> <p><b>Term:</b> Appointed as Non-Executive Independent Director for a period of five years i.e. till April 27, 2025 and not liable to retire by rotation</p> <p><b>Occupation:</b> Professional</p> <p><b>DIN:</b> 00005211</p>	Indian	53 years	<ul style="list-style-type: none"> <li>• Dyna Link Electronics Limited</li> <li>• Dyna Link Private Limited</li> <li>• Intercorridor Systems Limited</li> <li>• Mercury Link Systems Limited</li> <li>• Electronics Sector Skills Council Of India</li> <li>• Synegra Ems Limited</li> <li>• Attort Legal Consultancy Private Limited</li> <li>• Epic Electronics Products Foundation</li> </ul>

Sr. No.	Name , Designation, Address, Date of Birth, Occupation, Term and DIN	Nationality	Age	Other Directorships
5.	<p><b>Dinesh Shenoy</b></p> <p><b>Designation:</b> Non-Executive Independent Director</p> <p><b>Date of Birth:</b> June 08, 1963</p> <p><b>Address:</b> 61, Shantae Par waddo, Bardez Assonora, Assonora North Goa- 403503</p> <p><b>Date of Appointment as Additional Independent Director:</b> February 17, 2020</p> <p><b>Date of Appointment as Non-Executive Independent Director:</b> December 15, 2020</p> <p><b>Term:</b> Appointed as Independent Director for a period of five years i.e. till February 16, 2025 and not liable to retire by rotation</p> <p><b>Occupation:</b> Professional</p> <p><b>DIN:</b> 08699459</p>	Indian	59 years	Nil

#### BRIEF PROFILE OF OUR DIRECTORS

**Rajkumar Kamat**, aged 62 years is the Promoter, Chairperson & Managing Director of our Company. He graduated with a Diploma degree in the field of Science from University of Goa in the year 1981. He is into Manufacturing and Processing Business since 1991. He was previously associated with OM Ventures where he was responsible to oversee entire operations of the company which is into Manufacturing of composites, Bio and Metal products since 2002 in addition to his own business. He was also associated with Franchisee of Business Network International for Goa. He also has had a close encounter with Variety of Industries and Businesses for more than a decade like: 1) Past President of Goa State Industries Association ( GSIA ) 2) Founder President of Fire & Security Association of India ( FSAI ) 3) Ex Director of Goa Industrial Development Corporation ( GIDC ) 4) Managing Committee Member of Goa Chamber of Commerce & Industry ( GCCI ) 5) Member of Goa Investment Promotion Board ( IPB ).

**Shreyas Nadkarni**, aged 36 Years is Executive Director of our company. He has completed Post Graduate Diploma in Business Administration (PGDBA) Specialization - Operations Management Welingkar Institute of Management Development & Research, Mumbai. He was associated with the companies such as BNI (Business Network International) - Hubli Dharwad, Karnataka, Telstra India Pvt Ltd Bangalore, Zettata Technologies Pvt. Ltd, Bangalore, Bharti Airtel Limited Mumbai, SAP India Pvt. Ltd Mumbai, REGUS Business Centre Dubai, UAE

**Leena Kamat**, aged 56 years is the Promoter and Non- Executive Director of our Company. She has completed her Bachelor's Degree in the field of Science (B.SC.) from University of Bombay, Mumbai in the year 1988. She is into Manufacturing Business and is also responsible for Overseeing Operations of OM Ventures which is into Manufacture of Composite, Bio and Metal products since 2002 in addition to her own business.

**Nitin Kunkolienker**, aged 53 years is the Non-Executive Independent Director of Our Company. He has completed his Bachelor's of Commerce from Mumbai University in the year 1988. He holds various positions as member of committees like President of MAIT - 'Manufacturers' Association for Information Technology', (INDIA'S TOP BUSINESS ASSOCIATION COMMITTED TO MISSION DIGITAL INDIA OF HON. PRIME MINISTER), Chairman - Vibrant Goa Foundation, CII National Council 2021-22, Member of Managing Committee ASSOCHAM Board of Trustee of International Centre Goa, Permanent Invitee of Managing Committee of Goa chamber of Commerce and Industry Being past President of GCCI, Member of Governing Council /Board Member/Director at Electronic Sector Skill Development Council of India.(GOI INITIATIVE) , Member of General Assembly Sangath President of Goa Management Association since 2015 President Emeritus of Verna Industries Association. He also has served as a Member of Higher education council, headed by Hon. Chief Minister, Govt. of Goa and also Governing Council of National Productivity Council, New Delhi headed by Shri Piyush Goyal, Union CIM. He also holds position as President

of Vidya Vikas Mandal, Margao, Goa, Chairman of Vidya Vikas Academy, Chairman of Governing council, G. R. Kare college of Law, Margao, Goa Member of Governing Council, (Nominee of AICTE), Goa Engineering College, Top most Engineering college in Goa, Member of Board of Governance- Indian Institute of Technology (IIT), Goa

**Dinesh Shenoy**, aged 58 years is the Non-Executive Independent Director of our Company. He has completed his Bachelor's of Commerce from Mumbai University in the year 1985. He was associated for 12 years with Automobile Corporation of Goa Ltd, Bhuimpal Sattari, Goa as an Accounts officer and various other day-to-day activities. He has handled Audits, Accounts and Income tax matters being associated for one year with M/s. C.C. Chokshi & Co. Mumbai, Chartered Accountants firm. Presently handling Outsourcing jobs under the firm name M/s Shreeya Consultancy services.

## CONFIRMATIONS

As on the date of this Prospectus:

1. Except as stated below; none of the Directors of our Company are related to each other as per Section 2 (77) of the Companies Act, 2013.
  - Leena Kamat is the spouse of Rajkumar Kamat.
2. There are no arrangements or understanding with major shareholders, customers, suppliers or any other entity, pursuant to which any of the Directors or Key Management Personnel were selected as a Director.
3. The Directors of our Company have not entered into any service contracts with our Company which provides for benefits upon termination of employment.
4. None of the Directors are categorized as a Wilful Defaulter or a fraudulent borrower, as defined under Regulation 2(1) (III) of SEBI (ICDR) Regulations.
5. None of our Directors are or were directors of any Company whose shares have been/were suspended from trading by any of the stock exchange(s) during his/her tenure in that Company in the last five years or delisted from the stock exchange(s) during the term of their directorship in such companies.

## DETAILS OF BORROWING POWERS

Pursuant to a special resolution passed at an Extra-ordinary General Meeting of our Company held on December 15, 2020 and pursuant to provisions of Section 180(1)(c) and other applicable provisions, if any, of the Companies Act, 2013 and rules made thereunder, the Board of Directors of the Company be and are hereby authorized to borrow monies from time to time, any sum or sums of money on such security and on such terms and conditions as the Board may deem fit, notwithstanding that the money to be borrowed together with the money already borrowed by our Company may exceed in the aggregate, its paid up capital and free reserves and security premium (apart from temporary loans obtained / to be obtained from bankers in the ordinary course of business), provided that the outstanding principal amount of such borrowing at any point of time shall not exceed in the aggregate of ₹ 25 Crores

## REMUNERATION OF EXECUTIVE DIRECTORS

### **Rajkumar Kamat, Managing Director**

The compensation package payable to him as resolved in the Extra Ordinary General Meeting held on December 15, 2020 is stated hereunder:

**Salary:** The total remuneration payable to Rajkumar Kamat, Managing Director, shall be a sum of upto ₹ 30.00 lakhs per annum (inclusive of all salary, perquisites, benefits, incentives and allowances)

## PAYMENT OR BENEFIT TO NON – INDEPENDENT DIRECTOR AND NON - EXECUTIVE DIRECTORS OF OUR COMPANY

Pursuant to the resolution passed by the Board of Directors of our Company at their meeting held on January 11, 2022, the Non-Executive Directors including Independent Directors of our Company would be entitled to a sitting fee of ₹ 7500 for attending every meeting of Board or its committee thereof.



The Remuneration paid to the Directors during the last F.Y. 2021-22 is as follows:

(₹ in Lakhs)

Sr. No.	Name of Director	Remuneration paid
1.	Rajkumar Kamat	7.55
2.	Shreyas Nadkarni	Nil

## SHAREHOLDING OF OUR DIRECTORS

The following table sets forth the shareholding of our Directors as on the date of this Prospectus:

Sr. No.	Name of the shareholder	No. of Equity Shares	Percentage of Pre-Issue Capital (%)	Percentage of Post-Issue Capital (%)
1.	Leena Kamat	10,91,848	92.73%	65.03%
2.	Rajkumar Kamat	63,152	5.36%	3.76%
3.	Shreyas Nadkarni	8,334	0.71%	0.50%

## INTEREST OF DIRECTORS

All of our Directors may be deemed to be interested to the extent of fees payable to them for attending meetings of the Board or a committee thereof as well as to the extent of other remuneration and reimbursement of expenses payable to them under our Articles of Association, and to the extent of remuneration paid to them for services rendered as an officer or employee of our Company.

Our Directors may also be regarded as interested in the Equity Shares, if any, held by them or allotted to the companies in which they are interested as Directors, Members, and Promoter, pursuant to this Issue. All of our Directors may also be deemed to be interested to the extent of any dividend payable to them and other distributions in respect of the said Equity Shares.

### *Interest in the property of Our Company*

Except as stated in the heading titled “*Properties*” under the chapter titled “*Our Business*”, beginning on page no. 113 of this Prospectus, none of our Directors have interest in any property acquired or proposed to be acquired of our Company or by our Company.

### *Interest in promotion of Our Company*

Except, as stated in the chapter titled “*Our Promoter and Promoter Group*” beginning from page 113 none of our Directors are interested in the promotion of our company as on the date of this Prospectus.

### *Interest as Member of a Company or Firm*

Except as stated in this chapter titled “*Our Management*”, the section titled “*Related Party Transaction - Annexure XXIX of Restated Financial Statements*” and the chapter “*Our Business*” on page nos.121, **Error! Bookmark not defined.** and 72of this Prospectus respectively, our Directors do not have any other interest in our business.

## CHANGES IN OUR BOARD OF DIRECTORS DURING THE LAST THREE YEARS

Name of the Director	Date of Change	Reason for Change
Leena Kamat	January 17, 2020	Appointed as Non-Executive Director
*Rajkumar Kamat	April 28, 2020	Managing Director
Dinesh Shenoy	February 2, 2020	Appointed as Additional Non-Executive Independent Director
Nitin Kunkolienker	April 28, 2020	Appointed as Additional Non-Executive Independent Director
Nimisha Kamat	December 15, 2020	Cessation
Dinesh Shenoy	December 15, 2020	Appointed as Non-Executive Independent Director
Nitin Kunkolienker	December 15, 2020	Appointed as Non-Executive Independent Director
Shreyas Nadkarni	January 7, 2022	Appointed as Additional Executive Director
Shreyas Nadkarni	June 10, 2022	Appointed as Executive Director

\*Rajkumar Kamat was appointed as first director of the company.

## CORPORATE GOVERNANCE

In addition to the applicability of provisions of Companies Act, 2013 with respect to corporate governance, provisions of the SEBI (LODR) Regulations, 2015 have also been complied with, to the extent applicable to our Company.

Our Company stands committed to good Corporate Governance practices based on the principles such as accountability, transparency in dealing with our stakeholders, emphasis on communication and transparent report. We have complied with the requirements of the applicable regulations, including Regulations, in respect of Corporate Governance including constitution of the Board and its Committees. The Corporate Governance framework is based on an effective Independent Board, the Board's supervisory role from the executive management team and constitution of the Board Committees, as required under law.

Our Board functions either as a full Board or through the various committees constituted to oversee specific operational areas. As on the date of this Prospectus, our Company has five (5) Directors. Out of five (5) Directors, there is one (1) Managing Director, one (1) Executive Director one (1) Non Executive Director and (2) Non - Executive Independent Directors. Further, we have one (1) Women Director on our Board

The following committees have been constituted for compliance with Corporate Governance requirements:

- A. Audit Committee;
- B. Stakeholders Relationship Committee;
- C. Nomination and Remuneration Committee;

### A. AUDIT COMMITTEE

Our Board has constituted the Audit Committee vide Board Resolution dated April 28, 2020 in accordance with the Section 177 of the Companies Act, 2013. The audit committee comprises of:

Name of the Directors	Nature of Directorship	Designation in Committee
Rajkumar Kamat	Managing Director	Chairman
Dinesh Shenoy	Non - Executive Independent Director	Member
Nitin Kunkolienker	Non - Executive Independent Director	Member

The Company Secretary & Compliance Officer of the Company will act as the Secretary of the Committee.

The scope of Audit Committee shall include but shall not be restricted to the following:

- Oversight of the Issuer's financial reporting process and the disclosure of its financial information to ensure that the financial statement is correct, sufficient and credible.
- Recommending to the Board, the appointment, re-appointment and, if required, the replacement or removal of the statutory auditor and the fixation of audit fees.
- Approval of payment to statutory auditors for any other services rendered by the statutory auditors.
- Reviewing, with the management, the annual financial statements before submission to the board for approval, with particular reference to:
  1. Matters required to be included in the Director's Responsibility Statement to be included in the Board's report in terms of clause (c) of sub-section 3 of Section 134 of the Companies Act, 2013
  2. Changes, if any, in accounting policies and practices and reasons for the same.
  3. Major accounting entries involving estimates based on the exercise of judgment by management.
  4. Significant adjustments made in the financial statements arising out of audit findings.
  5. Compliance with listing and other legal requirements relating to financial statements.
  6. Disclosure of any related party transactions.
  7. Qualifications in the draft audit report.
- Reviewing, with the management, the half yearly financial statements before submission to the board for approval.

- Reviewing, with the management, the statement of uses/application of funds raised through an issue (public issue, rights issue, preferential issue, etc.), the statement of funds utilized for purposes other than those stated in the Issue document/notice and the report submitted by the monitoring agency monitoring the utilization of proceeds of a public or rights issue, and making appropriate recommendations to the Board to take up steps in this matter.
- Review and monitor the auditor's independence and performance, and effectiveness of audit process.
- Approval or any subsequent modification of transactions of the Company with related parties.
- Scrutiny of inter-corporate loans and investments.
- Valuation of undertakings or assets of the Company, wherever it is necessary;
- Evaluation of internal financial controls and risk management systems;
- Reviewing, with the management, performance of statutory and internal auditors, adequacy of the internal control systems.
- Reviewing the adequacy of internal audit function, if any, including the structure of the internal audit department, staffing and seniority of the official heading the department, reporting structure coverage and frequency of internal audit.
- Discussion with internal auditors any significant findings and follow up there on.
- Reviewing the findings of any internal investigations by the internal auditors into matters where there is suspected fraud or irregularity or a failure of internal control systems of a material nature and reporting the matter to the board.
- Discussion with statutory auditors before the audit commences, about the nature and scope of audit as well as post-audit discussion to ascertain any area of concern.
- To look into the reasons for substantial defaults in the payment to the depositors, debenture holders, shareholders (in case of non-payment of declared dividends) and creditors.
- To review the functioning of the Whistle Blower mechanism.
- Approval of appointment of CFO (i.e., the whole-time Finance Director or any other person heading the finance function or discharging that function) after assessing the qualifications, experience & background, etc. of the candidate.
- Carrying out any other function as is mentioned in the terms of reference of the Audit Committee.

Explanation (i): The term "related party transactions" shall have the same meaning as contained in the Accounting Standard 18, Related Party Transactions, issued by The Institute of Chartered Accountants of India.

Explanation (ii): If the Issuer has set up an audit committee pursuant to provision of the Companies Act, the said audit committee shall have such additional functions / features as is contained in this clause.

The Audit Committee enjoys following powers:

1. To investigate any activity within its terms of reference.
2. To seek information from any employee.
3. To obtain outside legal or other professional advice.
4. To secure attendance of outsiders with relevant expertise if it considers necessary.
5. The audit committee may invite such of the executives, as it considers appropriate (and particularly the head of the finance function) to be present at the meetings of the committee, but on occasions it may also meet without the

presence of any executives of the Issuer. The finance director, head of internal audit and a representative of the statutory auditor may be present as invitees for the meetings of the audit committee.

The Audit Committee shall mandatorily review the following information:

- a. Management discussion and analysis of financial condition and results of operations;
- b. Statement of significant related party transactions (as defined by the audit committee), submitted by management;
- c. Management letters / letters of internal control weaknesses issued by the statutory auditors;
- d. Internal audit reports relating to internal control weaknesses; and
- e. The appointment, removal and terms of remuneration of the Chief internal auditor shall be subject to review by the Audit Committee.

The recommendations of the Audit Committee on any matter relating to financial management, including the audit report, are binding on the Board. If the Board is not in agreement with the recommendations of the Committee, reasons for disagreement shall have to be incorporated in the minutes of the Board Meeting and the same has to be communicated to the shareholders. The Chairman of the committee has to attend the Annual General Meetings of the Company to provide clarifications on matters relating to the audit.

The Chairman of the committee has to attend the Annual General Meetings of the Company to provide clarifications on matters relating to the audit.

#### **Meeting Of Audit Committee and Relevant Quorum**

The audit committee shall meet at least four times in a year and not more than one hundred and twenty days shall elapse between two meetings. The quorum for audit committee meeting shall either be two members or one third of the members of the audit committee, whichever is greater, with at least two independent directors.

#### **B. STAKEHOLDERS' RELATIONSHIP COMMITTEE**

Our Board has constituted the Stakeholders' Relationship Committee vide Board Resolution April 28, 2020 in accordance with Section 178 of the Companies Act, 2013. The Stakeholder's Relationship Committee comprises of:

<b>Name of the Directors</b>	<b>Nature of Directorship</b>	<b>Designation in Committee</b>
Leena Kamat	Non-Executive Director	Chairman
Dinesh Shenoy	Non- Executive Independent Director	Member
Rajkumar Kamat	Managing Director	Member

The Company Secretary of the Company will act as the Secretary of the Committee.

This committee will address all grievances of Shareholders/Investors and its terms of reference include the following:

- a) Allotment and listing of our shares in future.
- b) Redressing of shareholders and investor complaints such as non-receipt of declared dividend, annual report, transfer of Equity Shares and issue of duplicate/split/consolidated share certificates;
- c) Monitoring transfers, transmissions, dematerialization, re-materialization, splitting and consolidation of Equity Shares and other securities issued by our Company, including review of cases for refusal of transfer/ transmission of shares and debentures;
- d) Reference to statutory and regulatory authorities regarding investor grievances;
- e) To otherwise ensure proper and timely attendance and redressal of investor queries and grievances;
- f) To do all such acts, things or deeds as may be necessary or incidental to the exercise of the above powers.

### Meeting of Stakeholder's Relationship Committee and Relevant Quorum

The quorum necessary for a meeting of the Stakeholder's Relationship Committee shall be two members or one third of the members, whichever is greater.

### C. NOMINATION AND REMUNERATION COMMITTEE

Our Board has constituted the Nomination and Remuneration Committee vide Board Resolution April 28, 2020 in accordance with section 178 of the Companies Act, 2013. The Nomination and Remuneration Committee comprises of:

Name of the Directors	Nature of Directorship	Designation in Committee
Leena Kamat	Non – Executive Director	Chairman
Dinesh Shenoy	Non - Executive Independent Director	Member
Nitin Kunkolienker	Non - Executive Independent Director	Member

The Company Secretary of our Company acts as the Secretary to the Committee.

The scope of Nomination and Remuneration Committee shall include but shall not be restricted to the following:

- a. Formulation of the criteria for determining qualifications, positive attributes and independence of a director and recommend to the Board a policy, relating to the remuneration of the directors, key managerial personnel and other employees;
- b. Formulation of criteria for evaluation of Independent Directors and the Board;
- c. Devising a policy on Board diversity;
- d. Identifying persons who are qualified to become directors and who may be appointed in senior management in accordance with the criteria laid down, and recommend to the Board their appointment and removal. The Company shall disclose the remuneration policy and the evaluation criteria in its Annual Report.

### Meeting of Nomination and Remuneration Committee and Relevant Quorum

The quorum necessary for a meeting of the Nomination and Remuneration Committee shall be two members or one third of the members, whichever is greater. The Committee is required to meet at least once a year.

### Policy on Disclosures & Internal procedure for prevention of Insider Trading

The provisions of Regulation 8 and 9 of the SEBI (Prohibition of Insider Trading) Regulations, 2015 will be applicable to our Company immediately upon the listing of its Equity Shares on the Stock Exchange. We shall comply with the requirements of the SEBI (Prohibition of Insider Trading) Regulations, 2015 on listing of our Equity Shares on stock exchange. Further, Board of Directors have approved and adopted the policy on insider trading in view of the proposed public issue.

Our Board is responsible for setting forth policies, procedures, monitoring and adherence to the rules for the preservation of price sensitive information and the implementation of the code of conduct under the overall supervision of the board.

## MANAGEMENT ORGANIZATION STRUCTURE

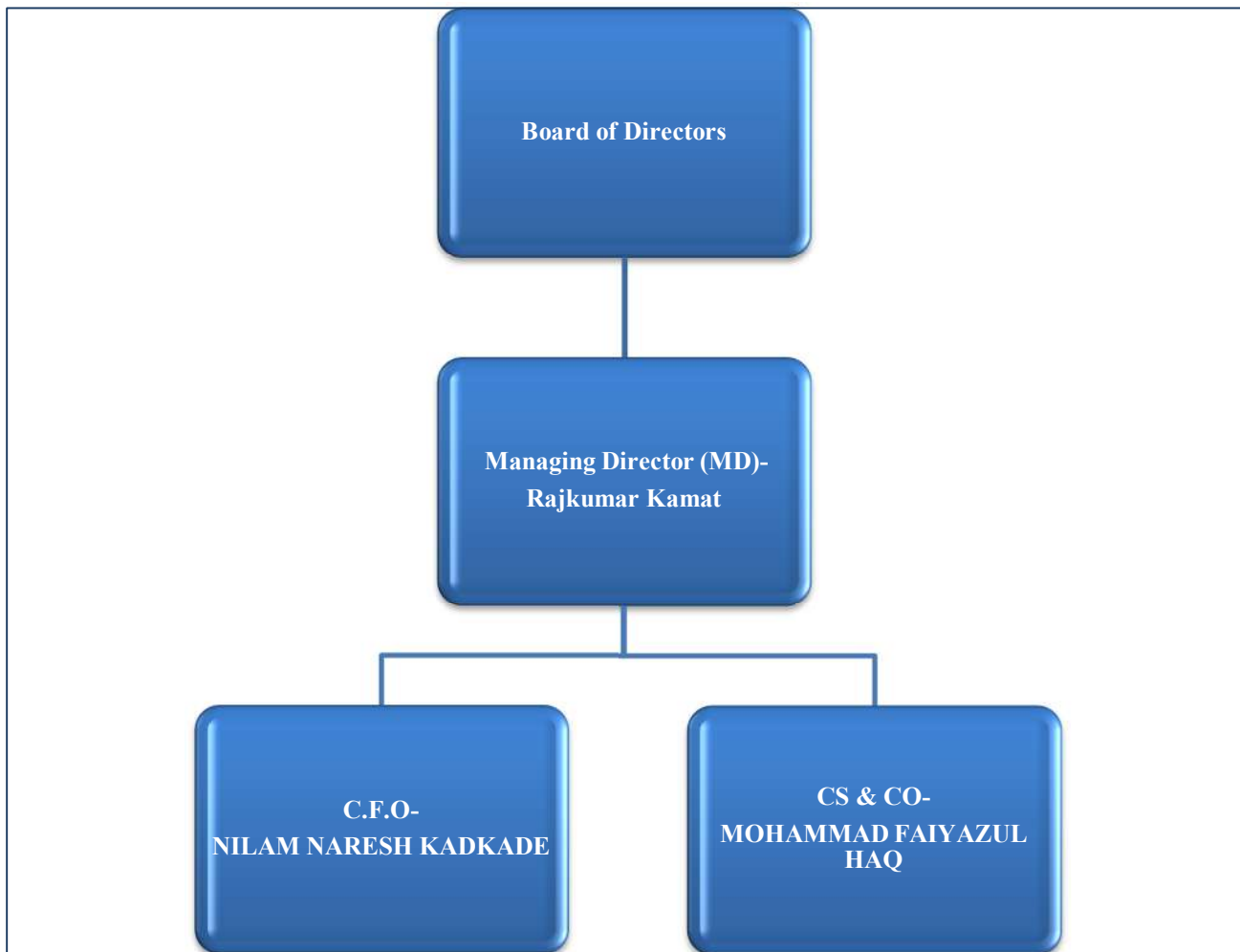

### Terms & Abbreviations

C.F.O.	- Chief Financial Officer
C.S & C.O.	- Company Secretary and Compliance Officer
MD	- Managing Director



## KEY MANAGERIAL PERSONNEL

Our Company is managed by our Board of Directors, assisted by qualified and experienced professionals, who are permanent employees of our Company. Below are the details of the Key Managerial Personnel of our Company:

Name of Employee	Designation	Date of Appointment	Compensation for last Financial Year	Qualification	Name of Previous Employer(s)	Total Years of Experience
Mohammad Faiyazul Haq	Company Secretary and Compliance Officer	April 28, 2020	4,20,000	• ICSI	• Gayatri Hi-Tech Hotels Limited	3 Years
Nilam Naresh Kadkade	Chief Financial Officer	April 28, 2020	2,98,394	• B. com	<ul style="list-style-type: none"> <li>• M/s OM Ventures</li> <li>• M/s Soham Real Estate Development Company Private Limited</li> <li>• M/s Visa Resources India Limited</li> <li>• M/s Chhaparia and Associates</li> <li>• M/s Websol Energy System Limited</li> </ul>	14 Years

### Other Notes –

- Further, none of our KMPs is forming part of related parties as per the Accounting Standard 18. For details, please see the chapter titled “*Financial Information- Annexure XXIV of Restated Financial Statements*” on page no. 121 & **Error! Bookmark not defined.** of this Prospectus.

## RELATIONSHIP BETWEEN KEY MANAGEMENT PERSONNEL

None of the aforementioned KMPs are related to each other.

## SHAREHOLDING OF THE KEY MANAGEMENT PERSONNEL

None of our KMPs holds any shares of our Company as on the date of this Prospectus.

## SERVICE CONTRACTS WITH KEY MANAGERIAL PERSONNEL

Our Key Managerial Personnel have not entered into any service contracts with our Company which provide for any benefits upon termination of their employment in our Company.

## INTEREST OF KEY MANAGERIAL PERSONNEL

None of our Key Management Personnel has any interest in our Company except to the extent of their remuneration, benefits, reimbursement of expenses incurred by them in the ordinary course of business. Our Key Managerial Personnel may also be interested to the extent of Equity Shares, if any, held by them and any dividend payable to them and other distributions in respect of such Equity Shares.

## ARRANGEMENT OR UNDERSTANDING WITH MAJOR SHAREHOLDERS/ CUSTOMERS/ SUPPLIERS

There are no arrangements or understanding with major shareholders, customers, suppliers or others, pursuant to which any of the Key Managerial Personnel was selected as a member of our senior management.

### **BONUS OR PROFIT SHARING PLAN OF THE DIRECTORS AND KEY MANAGEMENT PERSONNEL**

There is no profit sharing plan for the Key Managerial Personnel. However, our Company makes performance linked bonus payments, in accordance with their terms of appointment.

### **CONTINGENT AND DEFERRED COMPENSATION PAYABLE TO OUR DIRECTORS AND KEY MANAGERIAL PERSONNEL**

There is no contingent or deferred compensation payable to our Directors and Key Managerial Personnel, which does not form part of their remuneration.

### **EMPLOYEE SHARE PURCHASE AND EMPLOYEE STOCK OPTION PLAN**

Presently, we do not have ESOP/ESPS scheme for employees.

### **PAYMENT OR BENEFIT TO OUR KEY MANAGERIAL PERSONNEL**

Except for the payment of salaries and yearly bonus, we do not provide any other benefits to our employees.

### **CHANGES IN OUR KEY MANAGERIAL PERSONNEL IN THE LAST THREE YEARS FROM THE DATE OF FILING OF THIS PROSPECTUS**

The changes in our Key Managerial Personnel during the three years immediately preceding the date of filing of this Prospectus are set forth below.

<b>Name</b>	<b>Designation</b>	<b>Date of Appointment</b>
Mohammad Faiyazul Haq	Company Secretary and Compliance Officer	April 28, 2020
Nilam Naresh Kadkade	Chief Financial Officer	April 28, 2020

## OUR PROMOTER AND PROMOTER GROUP

### THE PROMOTERS OF OUR COMPANY ARE RAJKUMAR KAMAT AND LEENA KAMAT

As on the date of this Prospectus, our Promoters holds 11, 55,000 Equity Shares in aggregate, representing 98.09% of the issued, subscribed and paid-up Equity Share capital of our Company. For details of the build-up of our Promoter's shareholding in our Company, please see "*Capital Structure – Shareholding of our Promoter*" beginning on page no. 48 of this Prospectus.

The details of our Promoter are provided below:

<b>Rajkumar Kamat</b>	
	<b>Rajkumar Kamat</b> , aged 62 years is the Promoter, Chairperson & Managing Director of our Company. He graduated with a Diploma degree in the field of Science from University of Goa in the year 1981. He is into Manufacturing and Processing Business since 1991. He was previously associated with OM Ventures where he was responsible to oversee entire operations of the company which is into Manufacturing of composites, Bio and Metal products since 2002 in addition to his own business. He was also associated with Franchisee of Business Network International for Goa. He also has had a close encounter with Variety of Industries and Businesses for more than a decade like: 1) Past President of Goa State Industries Association ( GSIA ) 2) Founder President of Fire & Security Association of India ( FSAI ) 3) Ex Director of Goa Industrial Development Corporation ( GIDC ) 4) Managing Committee Member of Goa Chamber of Commerce & Industry ( GCCI ) 5) Member of Goa Investment Promotion Board ( IPB ).
<b>Date of Birth</b>	October 22, 1959
<b>Address</b>	H. No-323 Sneh, Vodlem Bhat, Taleigao, Tiswadi, Caranzalem, North Goa, Tiswadi, Goa-403002.
<b>PAN</b>	ADPPK9842G
<b>Name of Bank</b>	State Bank of India
<b>Bank A/c No.</b>	00000010294318546

<b>Leena Kamat</b>	
	<b>Leena Kamat</b> , aged 56 years is the Promoter and Non-Executive Director of our Company. She has completed her Bachelor's Degree in the field of Science (B.SC.) from University of Bombay, Mumbai in the year 1988. She is into Manufacturing Business and is also responsible for Overseeing Operations of OM Ventures which is into Manufacture of Composite, Bio and Metal products since 2002 in addition to her own business.
<b>Date of Birth</b>	September 14, 1965
<b>Address</b>	H. No-323 Sneh, Vodlem Bhat, Taleigao, Tiswadi, Caranzalem, North Goa, Tiswadi, Goa-403002.
<b>PAN</b>	AFCPK7018R
<b>Name of Bank</b>	Karur Vysya Bank Ltd
<b>Bank A/c No.</b>	2401177000000392

For the complete profile of our Promoter educational qualifications, professional experience, position/posts held in the past, directorships held, special achievements and business and financial activities, see "*Our Management*" on page no. 101 of this Prospectus.

### Other Undertakings and Confirmations

We confirm that the Permanent Account Number, Bank Account Number, Passport Number, Aadhaar Card & Driving Licence Number of our Promoters have been submitted to the Stock Exchange at the time of filing of the Draft Prospectus with the Stock Exchange.

Our Promoter and the members of our Promoter Group have confirmed that they have not been identified as wilful defaulter or a fraudulent borrower by the RBI or any other governmental authority. No violations of securities laws have been committed by our Promoters or members of our Promoter Group or any Group Companies in the past or are currently pending against them. None of (i) our Promoters and members of our Promoter Group or persons in control of or on the boards of bodies corporate forming part of our Group Companies (ii) the Companies with which any of our Promoters are or were associated as a promoters, director or person in control, are debarred or prohibited from accessing the capital markets or restrained from buying, selling, or dealing in securities under any order or directions passed for any reasons by the SEBI or any other authority or refused listing of any of the securities issued by any such entity by any stock exchange in India or abroad.

### **Change in Control of our Company**

There has not been any change in the control of our Company in the five years immediately preceding the date of this Prospectus.

### **Experience of our Promoter in the Business of our Company**

For details in relation to experience of our Promoter in the business of our Company, please refer the chapter “*Our Management*” beginning on page no. 101 of this Prospectus.

### **Interest of Promoter**

None of our Promoter / Directors have any interest in our Company except to the extent of compensation payable / paid, rents on properties owned by their relatives but used by our company and reimbursement of expenses (if applicable) and to the extent of any equity shares held by them or their relatives and associates or held by the companies, firms and trusts in which they are interested as director, member, partner, and / or trustee, and to the extent of benefits arising out of such shareholding. For further details please see the chapters titled “*Capital Structure*”, “*Financial Information*” and “*Our Management*” beginning on page nos. 48, **Error! Bookmark not defined.** and 101 of this Prospectus.

Except as stated otherwise in this Prospectus, we have not entered into any contract, agreements or arrangements in which our Promoter is directly or indirectly interested and no payments have been made to them in respect of the contracts, agreements or arrangements which are proposed to be made with them including the properties purchased by our Company other than in the normal course of business.

### **Interest of Promoter in the Promotion of our Company**

Our Company is currently promoted by the promoter in order to carry on its present business. Our Promoter is interested in our Company to the extent of their shareholding and directorship in our Company and the dividend declared, if any, by our Company.

### **Interest of Promoter in the Property of our Company**

Our Promoter has confirmed that he does not have any interest in any property acquired by our Company within three years preceding the date of this Prospectus or proposed to be acquired by our Company as on the date of this Prospectus except as mentioned under the section “*Our Business -Properties*”, “*Objects of the Issue*” and “*Financial Information-Annexure XXIV of Restated Financial Statements*” on page nos. 72, 56 and 121 respectively, of this Prospectus.

Further, other than as mentioned in the chapter titled “*Our Business*” & “*Objects of the Issue*” on page no. 72 & 56 of this Prospectus our Promoter does not have any interest in any transactions in the acquisition of land, construction of any building or supply of any machinery.

### **Related Party Transactions**

Except as stated in the “*Financial Information- Annexure XXIV of Restated Financial Statements*” on page no. 121 of this Prospectus, our Company has not entered into related party transactions with our Promoters.

### **Common Pursuits of Promoters and Promoter Group Companies**

Epee Metal Goa Private Limited and Epee Bio Solutions Private Limited have been authorised by its Memorandum of Associations to undertake activities which is similar to that of our Company. Further, currently we do not have any non-

compete agreement/arrangement with our Group Companies. Such a conflict of interest may have adverse effect on our business and growth. We shall adopt the necessary procedures and practices as permitted by law to address any conflict situations, as and when they may arise.

Further, our Company will adopt necessary procedures and practices as permitted by law to address any conflicting situation as and when they arise.

### **Payment of Amounts or Benefits to the Promoter or Promoter Group During the last two years**

Except as stated in the Section titled “*Financial Information- Annexure XXIV of Restated Financial Statements*” on page no. 121 of this Prospectus, there has been no payment of benefits to our Promoter or Promoter Group during the two years preceding the date of this Prospectus.

### **Material Guarantees**

Except as stated in the “*Financial Indebtedness*” and “*Financial Information*” beginning on page nos. 151 and 121 of this Prospectus respectively, our Promoter has not given any material guarantee to any third party with respect to the Equity Shares as on the date of this Prospectus.

### **Our Promoter Group**

Apart from our Promoter, as per Regulation 2(1) (pp) of the SEBI (ICDR) Regulation, 2018, the following individuals and entities shall form part of our Promoter Group:

#### **A. Natural Persons who are Part of the Promoter Group**

As per Regulation 2(1) (pp) (ii) of the SEBI (ICDR) Regulations, 2018, the following individuals form part of our Promoter Group:

<b>Relationship with the Promoter</b>	<b>Name of Relative</b>	
<b>Name of the Promoter</b>	<b>Rajkumar Kamat</b>	<b>Leena Kamat</b>
Father	Gajanan Vaman Kamat	Balkrishna Ramchandra Bhandare
Mother	Shalini Gajanan Kamat	Alka Balkrishna Bhandare
Spouse	Leena Kamat	Rajkumar Kamat
Daughter	Nimisha Rajkumar Kamat	Nimisha Rajkumar Kamat
	Ashma Rajkumar Kamat	Ashma Rajkumar Kamat
Brother(s)	Deepak Gajanan Kamat	Nitin Balkrishna Bhandare
	Dinesh Gajanan Kamat	
Sister(s)	Rupa Gajanan Kamat	Reshma A. Mhapne
		Pratima Rajiv Kamat
Spouse’s Father	Balkrishna Ramchandra Bhandare	Gajanan Vaman Kamat
Spouse’s Mother	Alka Balkrishna Bhandare	Shalini Gajanan Kamat
Spouse’s Brother(s)	Nitin Balkrishna Bhandare	Deepak Gajanan Kamat
		Dinesh Gajanan Kamat
Spouse’s Sister(s)	Reshma A. Mhapne	Rupa Gajanan Kamat
	Pratima Rajiv Kamat	

#### **B. Companies / Corporate Entities Forming Part of the Promoter Group**

As per Regulation 2(1) (pp) (iv) of the SEBI (ICDR) Regulations, 2018, the following Companies/Trusts/ Partnership firms/HUFs or Sole Proprietorships are forming part of our Promoter Group.

<b>Sr. No.</b>	<b>Name of Promoter Group Entity/Company</b>
1.	Epee Metal Goa Private Limited (EPMGPL)
2.	Epee Bio Solutions Private Limited (EPBSPL)

**Companies with which the Promoter has disassociated in the last three years**

Except as disclosed below, our Promoter have not disassociated themselves from any company or firm in the three years immediately preceding the date of this Prospectus

Sr. No.	Name of Promoter	Name of Entity	Reason for disassociation	Date of dissociation
1	Rajkumar Kamat	Govind Poy Oxygen Limited	Resignation as director and cessation of interest in the company	June 13, 2022

**Outstanding Litigation**

There is no outstanding litigation against our Promoter except as disclosed in the section titled “*Risk Factors*” and chapter titled “*Outstanding Litigation and Material Developments*” beginning on page nos. 152 of this Prospectus.



## OUR GROUP COMPANIES

The definition of ‘Group Companies’ as per the SEBI (Issue of Capital and Disclosure Requirements) Regulations, 2018, shall include such companies (other than promoter(s) and subsidiary/subsidiaries) with which there were related party transactions, during the period for which financial information is disclosed, as covered under the applicable accounting standards, and also other companies as considered material by the board.

In terms of the SEBI ICDR Regulations and in terms of the policy of materiality defined by the Board pursuant to its resolution dated January 11, 2022, our Group Companies includes :-

those companies disclosed as related parties in accordance with Accounting Standard (“AS 18”) issued by the Institute of Chartered Accountants of India, in the Restated Financial Statements of the Company for the last three financial years. Provided, companies which have been disclosed as related parties in the Restated Financial Statements of our Company for the last three financial years, and which are no longer associated with our Company have not been disclosed as Group Companies.

Accordingly, Epee Metal Goa Private Limited and Epee Bio Solutions Private Limited are identified as our Group Companies.

The details of our Group Companies are provided below:

### 1. EPEE METAL GOA PRIVATE LIMITED (EPMGPL)

#### *Corporate Information*

Epee Metal Goa Private Limited was incorporated on October 07, 2004 under the Companies Act, 1956 as a Private Limited Company, bearing Registration No. 003621. The CIN of EPEE is U51504GA2004PTC003621. The Registered Office is situated at AG-14 Campal Trade Centre Opp Kala Academy Panaji Goa- 403001.

#### *Nature of business*

To carry on in India and abroad the business of manufacturers, traders, import, export or otherwise deal in all kinds of house decoration and engineering products whether made from wood, brass, aluminium, fiber glass, plastics FRP, wrought iron or other alloys or metals and carry on the business by wholesale or retail and whether manufacturing or otherwise of house furnishers, upholsterers and dealers in hirers, repairs, cleaners, storers and warehouse of furniture, carpets, linoleums, furnishing fabrics and other food coverings, house utensils, China and glass goods fittings, colorful curtains, hand-made home furnishings and carpets, household requisites of all kinds and all things capable of being used therewith or in the maintenance, repair thereof.

#### *Financial Information*

The financial results derived from the Audited Financial Statements for Fiscals 2021, 2020 and 2019 are set forth below:

(₹ in lakhs)

Particulars	As at March, 31		
	2021	2020	2019
Equity Capital	1.00	1.00	1.00
Reserves and Surplus	7.48	3.60	2.74
Net worth	8.48	4.60	3.74
Total Revenue (including other income)	83.10	56.44	29.57
Profit/ (Loss) after tax	3.88	0.85	0.33
Earnings per share (face value of ₹ 10 each)	38.80	8.56	3.38
Net asset value per share (₹)	84.8	46.0	37.4

There are no significant notes by the auditors of EPEE in relation to the above mentioned financial statements for the specified last three audited Fiscals.

The above mentioned financial information is derived from the audited financial statements of EPMGPL. For further information of last three financial years of EPMGPL kindly refer our Company’s website at [www.epbiocomposites.com](http://www.epbiocomposites.com).

## 2. EPEE BIO SOLUTIONS PRIVATE LIMITED (EPBSPL)

### Corporate Information

Epee Bio Solutions Private Limited was incorporated on October 16, 2017 under the Companies Act, 2013 as a Private Limited Company, bearing Registration No.013375. The CIN of EPBSL is U36999GA2017PTC013375. The Registered Office is situated at Flat No. AG 14, Campal Trade Centre, Near Kala Academy, Panaji North Goa- 403001.

### Nature of business

To carry on trade and business of manufacturing , selling, exporting, all kinds of high quality Fiber Reinforced Polymer products such as Doors, Frames, walls, mobile, standalone and group toilet blocks, tanks and many more application and also to develop, manufacture, provides, undertake, design, import, export, distribute and deal Bio Toilet Solutions for Clean and Green Surroundings and Exquisite Product to Beautify and protect Homes and Workplaces while contributing towards a Clean, Green and Safe Surrounding and to aggregate and develop Fire Safety solutions for prevention of Fire related mishaps in Workplaces.

### Financial Information

The financial results derived from the Audited Financial Statements for Fiscals 2021, 2020 and 2019 are set forth below:

(₹ in lakhs)

Particulars	As at March, 31		
	2021	2020	2019
Equity Capital	0.25	0.25	0.25
Reserves and Surplus	0.63	0.34	2.75
Net worth	0.88	0.59	3.00
Total Revenue (including other income)	2.85	13.90	56.71
Profit/ (Loss) after tax	0.29	(2.41)	1.71
Earnings per share (face value of ₹ 10 each)	11.69	-96.63	68.51
Net asset value per share (₹)	35.3	23.6	120

There are no significant notes by the auditors of EPBSL in relation to the above mentioned financial statements for the specified last three audited Fiscals.

The above mentioned financial information is derived from the audited financial statements of EPBSPL. For further information of last three financial years of EPBSPL kindly refer our Company's website at [www.epbiocomposites.com](http://www.epbiocomposites.com)

### Material Litigations

There has been no material litigation arisen in the group companies, which may directly or indirectly affect our Company. For further details, please refer the chapter "Outstanding Litigation and Material Developments" on page no. 152 of this Prospectus.

### Group Companies which are sick industrial companies

None of our Group Companies has become a sick company under the erstwhile Sick Industrial Companies (Special Provisions) Act, 1985, as amended.

### Group Companies under winding up/insolvency proceedings

None of our Group Companies are under winding up/insolvency proceedings.

### Defunct Group Companies

During the five years immediately preceding the date of the Prospectus, our Group Companies has not remained defunct and no application has been made to the relevant registrar of companies for striking off the name of our Group Companies.

## COMMON PURSUITS

EPEE and EPBSL have been authorised by its Memorandum of Associations to undertake activities which is similar to that of our Company. Further, currently we do not have any non-compete agreement/arrangement with our Group Companies. Such a conflict of interest may have adverse effect on our business and growth. We shall adopt the necessary procedures and practices as permitted by law to address any conflict situations, as and when they may arise.

### **Related Party Transactions and Significance on the Financial Statements**

For details, please refer to the chapter titled “*Financial Information- Annexure XXIX of Restated Financial Statements*” beginning on page no. 121 of this Prospectus.

### **Business Interests or Other Interests**

Except as disclosed in “*Financial Statements*” on page no. 121 of this Prospectus, our Group Companies has no business interest in our Company.

## OTHER CONFIRMATIONS

Our Group Companies does not have any securities listed on any Stock Exchange. Further, our Group Companies has not made any public or rights issue (as defined under the SEBI ICDR Regulations) of securities in the three years preceding the date of this Prospectus. Further, neither have any of the securities of our Company or our Group Companies been refused listing by any stock exchange in India or abroad, nor has our Company or our Group Companies failed to meet the listing requirements of any stock exchange in India or abroad.

## **DIVIDEND POLICY**

Under the Companies Act, 2013, our Company can pay dividends upon a recommendation by its Board of Directors and approval by a majority of the shareholders. The shareholders of our Company have the right to decrease, not to increase the amount of dividend recommended by the Board of Directors. The dividends may be paid out of profits of a company in the year in which the dividend is declared or out of the undistributed profits or reserves of the previous years or out of both. The Articles of Association of our Company also gives the discretion to our Board of Directors to declare and pay interim dividends.

There are no dividends declared by our Company since Incorporation.

Our Company does not have a formal dividend policy. Any dividends to be declared shall be recommended by the Board of Directors depending upon the financial condition, results of operations, capital requirements and surplus, contractual obligations and restrictions, the terms of the credit facilities and other financing arrangements of our Company at the time a dividend is considered, and other relevant factors and approved by the Equity Shareholders at their discretion. When dividends are declared, all the Equity Shareholders whose names appear in the register of members of our Company as on the “record date” are entitled to be paid the dividend declared by our Company. Any Equity Shareholder who ceases to be an Equity Shareholder prior to the record date, or who becomes an Equity Shareholder after the record date, will not be entitled to the dividend declared by Our Company

## SECTION VII – FINANCIAL INFORMATION

### FINANCIAL STATEMENTS

To,

**The Board of Directors,  
EP Biocomposites Limited**  
D2/12, Bicholim Industrial Estate,  
Bicholim, Goa- 403529

Dear Sir/Ma'am,

1. We have examined the attached Restated Financial Statement along with the Significant Accounting Policies and related notes of EP Biocomposites Limited (the 'Company') as at and for the period ended on March 31, 2022, March 31, 2021 and March 31, 2020 annexed to this report and prepared by the Company for the purpose of inclusion in the Draft Prospectus / Prospectus (being collectively referred as "Offer Document") in connection with its proposed Initial Public Offer ("IPO") on the SME Platform of the BSE Limited ("BSE").
2. The said Restated Financial Statements and other Financial Information have been prepared in accordance with the requirements of:
  - i) Section 26 of Part I of Chapter III to the Companies Act, 2013("the Act") read with Companies (Prospectus and Allotment of Securities) Rules 2014;
  - ii) The Securities and Exchange Board of India (Issue of Capital and Disclosure Requirements) Regulations 2018 ("ICDR Regulations") issued by the Securities and Exchange Board of India ("SEBI") in pursuance to Section 11 of the Securities and Exchange Board of India Act, 1992 and related amendments / clarifications from time to time;
  - iii) The terms of reference to our engagements with the Company requesting us to carry out the assignment, in connection with the Offer Document being issued by the Company for its proposed IPO of equity shares on SME Platform of the BSE Limited ("BSE"); and
  - iv) The Guidance Note on Reports in Company Prospectus (Revised 2019) issued by the Institute of Chartered Accountants of India ("Guidance Note").
3. We have examined the accompanied 'Restated Statement of Profit and Loss' (**Annexure – II**) for the financial years ended on March 31, 2022, March 31, 2021 and March 31 2020 and the 'Restated Statement of Assets and Liabilities' (**Annexure-I**) as on above dates, forming Part of the 'Financial Information' dealt with by this Report, detailed below. Both read together with the Significant Accounting Policies and Notes to Accounts (**Annexure – IV & V**) thereon, which are the responsibility of the Company's management. The information has been extracted from the financial statements for the financial years ended on March 31, 2022, March 31, 2021 and March 31, 2020. The Financial Statements for the financial year ended on March 31, 2022 is audited by us, M/s. S.P. Bhandare & Associates, Chartered Accountant, being the Statutory Auditor of the Company for the respective period, which are all approved by the Board of Directors as on that date and upon which we have placed our reliance while reporting. The Financial Statements for the year ended March 31, 2021 and 2020 was audited by Gupta Agarwal & Associates, Chartered Accountants, being the then Statutory Auditor of the Company, which are all approved by the Board of Directors as on that date and upon which we have placed our reliance while reporting.
4. In terms of Schedule VI (Part A) (11) (II) (i) of the SEBI (ICDR) Regulations, 2018 and other provisions relating to accounts of EP Biocomposites Limited, we, M/s. S.P. Bhandare & Associates., Chartered Accountants, have been subjected to the peer review process of the Institute of Chartered Accountants of India (ICAI) and hold a valid certificate issued by the Peer Review Board of the ICAI.
5. Based on our examination, we further report that:
  - a. The "Restated Summary Statement of Assets and Liabilities" as set out in **Annexure I** to this report, of the Company as at March 31, 2022, March 31, 2021 and March 31, 2020 is prepared by the Company and approved by the Board of Directors. These Restated Summary Statement of Assets and Liabilities, have been arrived at after making such

adjustments and regroupings to the financial statements of the Company, as in our opinion were appropriate and more fully described in Significant Accounting Policies and Notes to Accounts as set out in **Annexure IV & V** to this Report.

- b. The “Restated Summary Statement of Profit and Loss” as set out in **Annexure II** to this report, of the Company for the financial years ended on March 31, 2022, March 31, 2021 and March 31, 2020 is prepared by the Company and approved by the Board of Directors. These Restated Summary Statement of Profit and Loss have been arrived at after making such adjustments and regroupings to the financial statements of the Company, as in our opinion were appropriate and more fully described in Significant Accounting Policies and Notes to Accounts as set out in **Annexure IV & V** to this Report.
- c. The “Restated Summary Statement of Cash Flow” as set out in **Annexure III** to this report, of the Company for the financial years ended on March 31, 2022, March 31, 2021 and March 31, 2020 is prepared by the Company and approved by the Board of Directors. These Statement of Cash Flow, as restated have been arrived at after making such adjustments and regroupings to the financial statements of the Company, as in our opinion were appropriate and more fully described in Significant Accounting Policies and Notes to Accounts as set out in **Annexure IV & V** to this Report.
- d. The Restated Financial Statements have been made after incorporating adjustments for:
  - i. The changes, if any, in accounting policies retrospectively in respective financial years to reflect the same accounting treatment as per the changed accounting policy for all the reporting period /years.
  - ii. Prior period and other material amount in the respective financial years to which they relate.
  - iii. Extra-ordinary items that need to be disclosed separately in the accounts requiring adjustments.

which are stated in the Notes to Accounts as set out in **Annexure V**:

- e. There were no qualifications in the Audit Reports issued by Statutory Auditor(s) for the financial years ended on March 31, 2022, March 31, 2021 and March 31, 2020 which would require adjustments in this Restated Financial Statements of the Company.
6. At the request of the company, we have also examined the following financial information ("Other Financial Information") proposed to be included in the offer document prepared by the management and approved by the board of directors of the company and annexed to this report:

Annexure of Restated Financial Statements of the Company:-

- i. Statement of Share Capital, as restated (Annexure - VI)
- ii. Statement of Reserves & Surplus, as restated (Annexure - VII)
- iii. Statement of Long Term Borrowings, as restated (Annexure- VIII)
- iv. Statement of Short Term Borrowings, as restated (Annexure- IX)
- v. Statement of Trade Payables, as restated (Annexure- X)
- vi. Statement of Other Current Liabilities, as restated (Annexure- XI)
- vii. Statement of Short Term Provisions, as restated (Annexure- XII)
- viii. Statement of Fixed Assets, as restated (Annexure- XIII)
- ix. Statement of Other Non-Current Assets, as restated (Annexure- XIV)
- x. Statement of Inventories, as restated (Annexure- XV)
- xi. Statement of Trade Receivables, as restated (Annexure - XVI)
- xii. Statement of Cash and Bank Balances, as restated (Annexure - XVII)
- xiii. Statement of Short Term Loans and advances, as restated (Annexure- XVIII)
- xiv. Statement of Other Current Assets, as restated (Annexure - XIX)
- xv. Statement of Revenue from Operations, as restated (Annexure – XX)
- xvi. Statement of Other Income, as restated (Annexure – XXI)
- xvii. Statement of Statement Of Raw Materials Consumed, as restated (Annexure – XXII)
- xviii. Statement of Changes In Inventories, as restated (Annexure – XXIII)
- xix. Statement of Employee Benefit Expenses, as restated (Annexure – XXIV)
- xx. Statement of Financial Cost, as restated (Annexure – XXV)
- xxi. Statement of Depreciation And Amortization, as restated (Annexure – XXVI)
- xxii. Statement of Contingent Liabilities, as restated (Annexure XXVII)
- xxiii. Statement of Dividend Declared, as restated (Annexure XXVIII)



- xxiv. Statement of Related Party Transactions, as restated (Annexure – XXIX)
- xxv. Statement of Tax Shelter, as restated (Annexure - XXX)
- xxvi. Statement of Capitalization, as restated ( Annexure – XXXI )

7. In our opinion, the Restated Financial Statements and the other Financial Information set forth in Annexure I to XXXI read with the significant accounting policies and notes to the restated financial statements have been prepared in accordance with section 26 of Companies Act, 2013 and the SEBI Regulations and the Guidance Note on the reports in Company Prospectus (Revised 2019) issued by the Institute of Chartered Accountants of India (ICAI).

Consequently the financial information has been prepared after making such regroupings and adjustments as were, in our opinion, considered appropriate to comply with the same. As a result of these regrouping and adjustments, the amount reported in the financial information may not necessarily be the same as those appearing in the respective audited financial statements for the relevant years.

- 8. This report should not in any way be construed as a re-issuance or re-dating of any of the previous audit reports issued by any other Firm of Chartered Accountants nor should this report be construed as a new opinion on any of the financial statements referred to therein.
- 9. We have no responsibility to update our report for events and circumstances occurring after the date of the report.
- 10. This report is intended solely for your information and for inclusion in the Offer document in connection with the Company's proposed IPO of equity shares and is not to be used, referred to or distributed for any other purpose without our prior written consent.

**For M/s. S.P. Bhandare & Associates,**  
**Chartered Accountants**  
FRN: 101157W

**S. P. Bhandare**  
Proprietor  
**Membership No:** 035615

**Place:** Goa  
**Date:** 06<sup>th</sup> June, 2022  
**UDIN:** 22035615AKTDYN4O30  
**Email:** sandip.bhandare@gmail.com

**EP BIOCOMPOSITES LIMITED**  
CIN: U28900GA2020PLC014240

**Annexure I : STATEMENT OF ASSETS & LIABILITIES, AS RESTATED**

*(Rs. In lakhs)*

Particulars	Annexure No	Financial Year Ended March		
		2022	2021	2020
<b>EQUITY AND LIABILITIES</b>				
<b>1. Shareholder's funds</b>				
a) Share Capital	VI	117.75	5.00	5.00
b) Reserves and surplus	VII	82.09	33.65	(2.15)
<b>Total Shareholder's Fund (1)</b>		<b>199.84</b>	<b>38.65</b>	<b>2.85</b>
<b>2. Share application money pending allotment</b>				
		-	-	-
<b>3. Non-current liabilities</b>				
a) Long term borrowings	VIII	217.52	-	0.25
b) Deferred Tax Liabilities ( Net)		0.52	-	-
c) Long Term Provisions		1.72	-	-
<b>Total (3)</b>		<b>219.76</b>	<b>-</b>	<b>0.25</b>
<b>4. Current liabilities</b>				
a) Short Term Borrowings	IX	193.59	-	-
b) Trade Payables	X			
- total outstanding dues of micro enterprises and small enterprises		105.10	-	-
- total outstanding dues of creditors other than micro enterprises and small enterprises		114.64	64.41	46.39
c) Other Current Liabilities	XI	49.58	17.54	4.51
d) Short-term provisions	XII	45.18	11.78	1.16
<b>Total (4)</b>		<b>508.09</b>	<b>93.73</b>	<b>52.06</b>
<b>TOTAL - (1)+(2)+(3)+(4)</b>		<b>927.69</b>	<b>132.38</b>	<b>55.16</b>
<b>ASSETS</b>				
<b>1. Non - Current Assets</b>				
a) Property, Plant & Equipment and Intangible Assets				
i. Property, Plant & Equipment	XIII	23.73	0.24	-
ii) Intangible Assets		17.32	-	-
b) Deferred Tax Assets		-	-	-
c) Other Non-Current Assets	XIV	28.95	2.04	0.20
<b>Total (1)</b>		<b>70.00</b>	<b>2.28</b>	<b>0.20</b>
<b>2. Current Assets</b>				
a) Inventories	XV	118.25	45.00	11.12
b) Trade Receivables	XVI	709.64	64.71	30.19
c) Cash and Bank Balances	XVII	15.60	14.79	11.57
d) Short-term loans and advances	XVIII	4.62	2.10	1.03
e) Other Current Assets	XIX	9.58	3.50	1.05
<b>Total (2)</b>		<b>857.69</b>	<b>130.10</b>	<b>54.96</b>
<b>TOTAL - (1)+(2)</b>		<b>927.69</b>	<b>132.38</b>	<b>55.16</b>

The above statement should be read with Basis of Preparation and the Significant Accounting Policies appearing in Annexure IV, Notes to the Restated Financial Information & Adjustments to Audited Financial Statements appearing in Annexure V.

M/s. S.P. Bhandare & Associates  
Chartered Accountants  
FRN: 101157W

For and on behalf of the Board of Directors of  
EP Biocomposites Limited

CA Sandip P. Bhandare  
Partner  
M. No. 035615

Rajkumar Kamat  
Chairman & Managing Director

Leena Kamat  
Director

Nilam Naresh Kadkade  
Chief Financial Officer

Mohammad Faiyazul Haq  
Company Secretary

Place: Panaji , Goa  
Date: June 06, 2022

Place: Panaji , Goa  
Date: June 06, 2022

**EP BIOCOMPOSITES LIMITED**  
CIN: U28900GA2020PLC014240

**Annexure II : STATEMENT OF PROFIT & LOSS ACCOUNT, AS RESTATED**

*(Rs. In lakhs)*

Particulars	Annexure No	Financial Year Ended March		
		2022	2021	2020
<b>INCOME</b>				
Revenue from Operations	XX	805.96	294.80	56.81
Other Income	XXI	1.59	0.43	0.02
<b>Total Income</b>		<b>807.55</b>	<b>295.23</b>	<b>56.83</b>
<b>EXPENSES:</b>				
Cost of material consumed	XXII	569.39	179.41	27.09
Trading Goods Purchases		-	28.13	26.00
Changes in Inventories	XXIII	(73.08)	(25.77)	(5.14)
Employee Benefit Expenses	XXIV	103.21	47.22	0.84
Financial Cost	XXV	15.62	-	-
Depreciation & Amortisation cost	XXVI	6.60	0.03	-
Other Expenses		69.21	19.79	3.73
<b>Total expenses</b>		<b>690.95</b>	<b>248.81</b>	<b>52.52</b>
<b>Exceptional and prior period items</b>			-	-
<b>Net Profit / (Loss) before Tax</b>		<b>116.60</b>	<b>46.42</b>	<b>4.31</b>
<b>Less: Provision for Tax</b>				
(a) Current Tax		31.66	10.62	1.16
(b) Prior Period Tax		3.48	-	-
(c) Deferred Tax		0.52	0.00	-
<b>Total</b>		<b>35.66</b>	<b>10.62</b>	<b>1.16</b>
<b>Net Profit / ( Loss ) for the period after tax but before extra ordinary items</b>		<b>80.94</b>	<b>35.80</b>	<b>3.15</b>
Extraordinary Items		-	-	-
<b>Net Profit / ( Loss ) for the period after tax and after extra ordinary items available for appropriation</b>		<b>80.94</b>	<b>35.80</b>	<b>3.15</b>

The above statement should be read with Basis of Preparation and the Significant Accounting Policies appearing in Annexure IV, Notes to the Restated Financial Information & Adjustments to Audited Financial Statements appearing in Annexure V.

**M/s. S.P. Bhandare & Associates**  
Chartered Accountants  
FRN: 101157W

**For and on behalf of the Board of Directors of**  
**EP Biocomposites Limited**

**CA Sandip P. Bhandare**  
Partner  
M. No. 035615

**Rajkumar Kamat**  
Chairman & Managing Director

**Leena Kamat**  
Director

**Nilam Naresh Kadkade**  
Chief Financial Officer

**Mohammad Faiyazul Haq**  
Company Secretary

Place: Panaji , Goa  
Date: June 06, 2022

Place: Panaji , Goa  
Date: June 06, 2022

**EP BIOCOMPOSITES LIMITED**  
CIN: U28900GA2020PLC014240

**Annexure III : CASHFLOW STATEMENT, AS RESTATED**

*(Rs. In lakhs)*

Particulars	Financial Year Ended March		
	2022	2021	2020
<b>Cash Flow From Operating Activities</b>			
Net Profit Before Tax	116.60	46.42	4.31
Adjustments for :			
Depreciation/Amortisation	6.60	0.03	-
Income From Other Sources	(1.59)	(0.43)	-
Finance cost	15.62	-	-
<b>Operating Profit Before Working Capital Adjustment</b>	<b>137.23</b>	<b>46.02</b>	<b>4.31</b>
<b>Adjustment for Changes in Working Capital</b>			
Trade and other payable	155.33	18.02	46.39
Inventories	(73.25)	(33.88)	(11.12)
Other Current Liabilities	32.04	13.03	4.51
Provisions	15.24	-	-
Trade and other Recievables	(644.93)	(34.52)	(30.19)
Other Non Current assets	(26.91)	(1.84)	(0.20)
Short Term Loans & Advances	(2.51)	(1.07)	(1.03)
Other Current Assets	(4.91)	(1.83)	(1.05)
<b>Cash Flow Generated from Operations</b>	<b>(412.67)</b>	<b>3.93</b>	<b>11.62</b>
Taxes Paid	16.44	0.62	-
<b>Net Cash flow from Operating activities (A)</b>	<b>(429.11)</b>	<b>3.31</b>	<b>11.62</b>
<b>Cash Flow From Investing Activities</b>			
(Purchase)/Sale of Fixed Assets	(47.42)	(0.27)	-
Changes in Capital WIP	-	-	-
Interest Received	1.59	0.43	-
<b>Net Cash Flow from Investing Activites ( B)</b>	<b>(45.83)</b>	<b>0.16</b>	<b>-</b>
<b>Cash Flow From Financing Activities</b>			
Proceeds from/ ( Repayment of ) Borrowing	411.11	(0.25)	0.25
Proceeds from Share Capital	80.25	-	5.00
Proceeds from Share Capital pending allotment	-	-	-
Finance cost	(15.62)	-	-
IPO Expenses	-	-	(5.30)
<b>Net Cash Flow From Financing Activities (C)</b>	<b>475.74</b>	<b>(0.25)</b>	<b>(0.05)</b>
Net Increase/ ( Decrease) in Cash and Cash Equivalents ( A + B + C )	0.80	3.22	11.57
Cash & Cash equivalent at the beginning of the year	14.79	11.57	-
<b>Cash &amp; Cash Equivalent at the end of the year</b>	<b>15.60</b>	<b>14.79</b>	<b>11.57</b>

**Cash and Cash Equivalents comprises of :**

Particulars	Financial Year Ended		
	2022	2021	2020
Cash-in-Hand	0.19	0.24	0.14
Balance with Banks	0.95	2.56	11.18
Balance in FD	14.46	11.99	0.25
Fixed deposit for Perfomance guarantee and Bank guarantee	-	-	-
<b>Total</b>	<b>15.60</b>	<b>14.79</b>	<b>11.57</b>

The above statement should be read with Basis of Preparation and the Significant Accounting Policies appearing in Annexure IV, Notes to the Restated Financial Information & Adjustments to Audited Financial Statements appearing in Annexure V.

M/s. S.P. Bhandare & Associates  
Chartered Accountants  
FRN: 101157W

For and on behalf of the Board of Directors of  
EP Biocomposites Limited

CA Sandip P. Bhandare  
Partner  
M. No. 035615

Rajkumar Kamat  
Chairman & Managing Director  
Leena Kamat  
Director

Nilam Naresh Kadkade  
Chief Financial Officer  
Mohammad Faiyazul Haq  
Company Secretary

Place: Panaji , Goa  
Date: June 06, 2022

Place: Panaji , Goa  
Date: June 06, 2022

**ANNEXURE IV : NOTES TO AND FORMING PART OF BALANCE SHEET AND STATEMENT OF PROFIT AND LOSS  
FOR THE YEAR ENDED 31-03-2022**

**Note :1**

**CORPORATE INFORMATION**

EP BIOCOMPOSITES LIMITED is a Public Limited Company domiciled in India and incorporated under the provisions of the Companies Act, 2013 on 17th January, 2020. The Company is engaged in manufacture of fibre reinforced polymere products and providing of bio toilet Solutions.

**Note :2**

**SIGNIFICANT ACCOUNTING POLICIES & NOTES :**

**1 Basis Of Preparation of Financial Statements**

These financial statements of the Company have been prepared in accordance with generally accepted accounting principles in India (Indian GAAP) to comply with the Accounting Standards specified under section 133 of the Companies Act, 2013, read with Rule 7 of the companies (Accounts) Rules, 2014 and the relevant provisions of the Companies Act, 2013 ("the Act"). The financial statements have been prepared on accrual basis under the historical cost convention.

All assets and liabilities have been classified as current or non-current as per the Company's normal operating cycle and other criteria set out in the Schedule III to the Companies Act, 2013. Based on the nature of products and the time between the acquisition of assets for processing and their realization in cash and cash equivalents, the Company ascertained its operating cycle as 12 months for the purpose of current and non-current classification of assets and liabilities.

**2 Use Of Estimates**

The preparation of financial statements in conformity with Indian GAAP requires the management to make judgments, estimates and assumptions that affect the reported amounts of revenues, expenses, assets and liabilities and the disclosure of contingent liabilities, at the end of the reporting period. Although these estimates are based on the management's best knowledge of current events and actions, uncertainty about these assumptions and estimates could result in the outcomes requiring a material adjustment to the carrying amounts of assets or liabilities in future periods.

**3 Cash and cash equivalents**

Cash and cash equivalents for the purposes of cash flow statement comprise cash at bank and in hand and short-term investments with an original maturity of three months or less.

**4 Taxes on Income**

Tax expense comprises current and deferred tax. Current income tax is measured at the amount expected to be paid to the tax authorities in accordance with the Income-tax Act, 1961 enacted in India and tax laws prevailing in the respective tax jurisdictions where the company operates. The tax rates and tax laws used to compute the amount are those that are enacted or substantively enacted, at the reporting date.

Deferred Income taxes reflect the impact of timing differences between taxable income and accounting Income originating during the current year and reversal of timing differences for the earlier years. Deferred tax is measured using the tax rates and the tax laws enacted or substantively enacted at the reporting date. Deferred income tax relating to items recognized directly in equity is recognized in equity and not in the statement of profit and loss.

Deferred tax liabilities are recognized for taxable timing differences. Deferred tax assets are recognized for deductible timing differences only to the extent that there is reasonable certainty that sufficient future taxable income will be available against which such deferred tax assets can be realized. In situations where the company has unabsorbed depreciation or carry forward tax losses, all deferred tax assets are recognized only if there is virtual certainty supported by convincing evidence that they can be realized against future taxable profits.

At each reporting date, the company re-assesses unrecognized deferred tax assets. It recognizes unrecognized deferred tax asset to the extent that it has become reasonably certain or virtually certain as the case may be that sufficient future taxable income will be available against which such deferred tax assets can be realized.

The carrying amount of deferred tax assets are reviewed at each reporting date. The company writes-down the carrying amount of deferred tax asset to the extent that it is no longer reasonably certain or virtually certain as the case may be that sufficient future taxable income will be available against which deferred tax asset can be realized. Any such write-down is reversed to the extent that it becomes reasonably certain or virtually certain as the case may be that sufficient future taxable income will be available.

Deferred tax assets and deferred tax liabilities are offset, if a legally enforceable right exists to set-off current tax assets against current tax liabilities and the deferred tax assets and deferred taxes relate to the same taxable entity and the same taxation authority.

## **5 Investments**

Investments, which are readily realizable and intended to be held for not more than one year from the date on which such investments are made, are classified as Current Investments. All other investments are classified as Long Term Investments.

On initial recognition, all investments are measured at cost. The cost comprises purchase price and directly attributable acquisition charges such as brokerage, fees and duties. Long term investments are carried in the financial statements at cost.

On disposal of an investment, the difference between its carrying amount and net disposal proceeds is charged or credited to the statement of profit and loss.

## **6 Property, Plant and Equipment, Tangible Assets**

Property, plant and equipment (PPE), being fixed assets are tangible items held for use or for administrative purposes and are measured at cost less accumulated depreciation and any accumulated impairment. Cost comprises of the purchase price including import duties and non-refundable purchase taxes after deducting trade discounts and rebates and any costs attributable to bringing the asset to the location and condition necessary for it to be capable of operating in the manner intended by the Management. Financing costs relating to acquisition of assets which take substantial period of time to get ready for intended use are also included to the extent they relate to the period up to the time such assets are ready for their intended use. Gains or losses arising from derecognition of property, plant & equipment are measured as the difference between the net disposal proceeds and the carrying amount of the asset and are recognized in the statement of profit and loss when the asset is derecognized. The residual values, useful lives and methods of depreciation of property, plant & equipment are reviewed at each financial year end and adjusted prospectively, if appropriate.

### **Depreciation**

Depreciation on Property, Plant and equipment are provided under written down value method as per the useful lives and manner prescribed under schedule II to the Companies Act, 2013. Depreciation is calculated after reclassification of assets.

### **Intangible Assets**

Intangible Assets are recognised only if it is probable that future economic benefits that are attributable to the asset will flow to the enterprise and the cost of the asset can be measured reliably.

### **Depreciation**

## **7 Current Assets, Loans & Advances**

In the opinion of the Board and to the best of its knowledge and belief the value on realisation of current assets in the ordinary course of business would not be less than the amount at which they are stated in the Balance Sheet and payable on demand.

## **8 Inventories**

Finished and Semi-Finished products produced and Raw materials purchased by the Company are carried at lower of cost and net realisable value after providing for obsolescence, if any.

Cost of inventories comprises all costs of purchase, cost of conversion and other costs incurred in bringing them to their respective present location and condition.

## **9 Recognition of Income & Expenditure**

Income and expenditure is recognized and accounted for on accrual basis. Revenue is recognised to the extent that it is probable that the economic benefits will flow to the Company and the revenue can be reliably measured. Revenue from sale of goods is recognised on transfer of significant risks and rewards of ownership to the customer and when no significant uncertainty exists regarding realisation of the consideration. Sales are recorded net of sales returns, sales tax/VAT/GST, cash and trade discounts.

## **10 Earning Per Shares**

The Company reports Basic and Diluted earnings per equity share in accordance with the Accounting Standard - 20 on Earning Per Share. In determining earning per share, the Company considers the net profit after tax and includes the post tax effect of any extraordinary/exceptional items. The number of shares used in computing basic earning per share is the weighted average number of equity shares outstanding during the period. The numbers of shares used in computing diluted earning per share comprises the weighted average number of equity shares that would have been issued on the conversion of all potential equity shares. Dilutive potential equity shares have been deemed converted as of the beginning of the period, unless issued at a later date.

## **11 Provision, Contingent Liabilities and Contingent Assets**

Provisions involving substantial degree of estimation in measurement are recognised when there is a present obligation as a result of past events and it is probable that there will be an outflow of resources.

Contingent Liabilities are not recognised but are disclosed in the notes. Contingent Assets are neither recognised nor disclosed in the financial statements.



ANNEXURE V  
NOTES TO ACCOUNTS

1) Managerial Remuneration

(Rs. In lakhs)

Particulars	Financial Year Ended March		
	2022	2021	2020
<b>Executive Directors Remuneration</b>			
Salary and allowances	7.55	5.73	-
<b>Non-executive Directors Remuneration</b>			
Sitting Fees	-	-	-
<b>Total</b>	<b>7.55</b>	<b>5.73</b>	<b>-</b>

2) Remuneration to Statutory Auditors

(Rs. In lakhs)

Particulars	Financial Year Ended March		
	2022	2021	2020
Statutory Audit Fees	1.25	0.25	0.25
For Taxation Matters	-	-	-
Other Certification	-	-	-
<b>Total</b>	<b>1.25</b>	<b>0.25</b>	<b>0.25</b>

3) Deferred Tax :

Deferred tax liability on account of timing difference between taxable income and accounting income for the year is accounted. The company has accounted for Income Tax in compliance with the accounting standard relating 'accounting' for taxes on

(Rs. In lakhs)

Particulars	Financial Year Ended March		
	2022	2021	2020
<b>Deferred tax liabilities/(assets) arising on account of timing difference in:</b>			
Opening Balance	-	-	-
Depreciation	0.52	0.00	-
<b>Closing Balance</b>	<b>0.52</b>	<b>0.00</b>	<b>-</b>

4) Information Regarding Foreign Exchange earnings

(Rs. In lakhs)

Particulars	Financial Year Ended March		
	2022	2021	2020
Earning in Foreign Exchange	3.28	-	-
Expenditure in Foreign Exchange	-	-	-
<b>Total</b>	-	-	-

5) The Management has confirmed that adequate provisions have been made for all the known and determined

6) There is no Auditor's Qualification in any of the audited Financial Statements as at and for the period ended March

**ADJUSTMENTS MADE IN RESTATED FINANCIAL STATEMENTS / REGROUPING NOTES**

Adjustments having impact on profit

Impact on Profit and Loss A/c

(Rs. In lakhs)

Particulars	Financial Year Ended March		
	2022	2021	2020
<b>Profit as per Audited Financials</b>	80.94	35.80	3.15
Add/ (Less): Adjustment in total income rectified	-	-	-
Add/ (Less): Difference in Duties and taxes	-	-	-
Add/ (Less): Difference in Preliminary expense rectified	-	-	-
Add/ (Less): Difference in Depreciation rectified	-	-	-
Add/ (Less): Difference in Deferred tax rectified	-	-	-
<b>Profit as per Restated Financials</b>	<b>80.94</b>	<b>35.80</b>	<b>3.15</b>

Changes done in reserves & surplus has been restated for the financial years ---

(Rs. In lakhs)

Particulars	Financial Year Ended March		
	2022	2021	2020
<b>Reserves &amp; Surplus as per audited financial statement</b>	82.09	33.65	(2.15)
Add/ (Less): Impact on Profit and Loss A/c			
Add/ (Less): Difference in Opening Reserves			
<b>Reserves &amp; Surplus as per restated financial statement</b>	<b>82.09</b>	<b>33.65</b>	<b>(2.15)</b>

Adjustments not having impact on profit

Appropriate adjustments have been made in the restated summary statements, wherever required, by a reclassification of the corresponding items of income, expenses, assets, liabilities and cash flows in order to bring them in line with the groupings as per the latest audited financial statements of the Company, prepared in accordance with Schedule III and the requirements of the Securities and Exchange Board of India (Issue of Capital & Disclosure Requirements) Regulations, 2018 (as amended).

Annexure - VI  
STATEMENT OF SHARE CAPITAL, AS RESTATED

(Rs. In lakhs)

Particulars	Financial Year Ended March		
	2022	2021	2020
<b>SHARE CAPITAL</b>			
<b>Authorised Share Capital :</b>			
1,50,000 Equity Shares of Rs.10/- each	-	15.00	15.00
20,00,000 Equity Shares of Rs.10/- each	200.00	-	-
	<b>200.00</b>	<b>15.00</b>	<b>15.00</b>
<b>Issued Subscribed and Paid Up Equity Share Capital :</b>			
50,000 Equity Shares of Rs.10/- each (Fully paid shares)	-	5.00	5.00
11,77,500 Equity Shares of Rs.10/- each (Fully paid shares)	117.75	-	-
	<b>117.75</b>	<b>5.00</b>	<b>5.00</b>
<b>Total</b>	<b>117.75</b>	<b>5.00</b>	<b>5.00</b>

Reconciliation of number of shares outstanding :

Particulars	Financial Year Ended March		
	2022	2021	2020
<b>Equity Shares</b>			
At the beginning of the period	50,000	50,000	-
Bonus Issue ( issued on 16th September 2021)	325,000	-	-
Addition during the period	802,500	-	50,000
<b>Outstanding at the end of the period</b>	<b>1,177,500</b>	<b>50,000</b>	<b>50,000</b>
<b>Total</b>	<b>1,177,500</b>	<b>50,000</b>	<b>50,000</b>

Name of Equity Shareholders holding more than 5% equity shares

Name of Shareholder	As at March 31					
	2022		2021		2020	
	No. of Shares held	% of Holding	No. of Shares held	% of Holding	No. of Shares held	% of Holding
Mrs. Leena Kamat	1,091,848	92.73%	45,000	90.00%	45,000	90.00%
Mr Rajkumar Gajanan Kamat	63,152	5.36%	2,000	4.00%	2,000	4.00%
<b>Total</b>	<b>1,155,000</b>	<b>98.09%</b>	<b>47,000</b>	<b>94.00%</b>	<b>47,000</b>	<b>94.00%</b>

Details of Shares held by Promoters at the end of the year

Promoter Name	As at March 31, 2022			As at March 31, 2020		
	No. Of Shares	% of total shares	% Change during the year	No. Of Shares	% of total shares	% Change during the year
Mrs. Leena Kamat	1,091,848	92.73%	2.73%	45,000	90.00%	0.00%
Mr Rajkumar Gajanan Kamat	63,152	5.36%	1.36%	2,000	4.00%	0.00%
<b>Total</b>	<b>1,155,000</b>	<b>98.09%</b>	<b>4.09%</b>	<b>47,000</b>	<b>94.00%</b>	<b>0.00%</b>

Annexure-VII

STATEMENT OF RESERVES AND SURPLUS, AS RESTATED

(Rs. In lakhs)

Particulars	Financial Year Ended March		
	2022	2021	2020
<b>Surplus</b>			
Balance as at the beginning of the year	33.65	(2.15)	-
<b>Less:</b> Bonus Shares issued ( issued on 16th September 2021)	32.50	-	-
<b>Add:</b> Profit / (Loss) for the year transferred to reserves	80.94	35.80	3.15
<b>Less:</b> IPO Expenses	-	-	5.30
<b>Balance as at the end of the year</b>	<b>82.09</b>	<b>33.65</b>	<b>(2.15)</b>

## Annexure - VIII

## STATEMENT OF LONG TERM BORROWINGS, AS RESTATED

(Rs. In lakhs)

Particulars	Financial Year Ended March		
	2022	2021	2020
<b>Unsecured Loans</b>			
Loan from Related Parties- Director - Carrying Interest @10.50%	131.20		0.25
<b>Unsecured Loans</b>			
Loan from Related Parties- Director - Interest free	86.32	-	
<b>Total</b>	<b>217.52</b>	<b>-</b>	<b>0.25</b>

Out of the above loan, loans of Rs.131.20 lakhs, are interest free. Further no terms of repayment have been specified for these loans. The balance loan of Rs. 92.91 lakhs(including current maturities of Rs. 6.59 lakhs - see Annexure X) Carries interest rate 10.50 % and is repayable over a period of 120 months with an EMI of Rs. 1.35 lakhs per month.

The loan of Rs. 92.91 lakhs (including current maturities of Rs. 6.59 lakhs - see Annexure X) was taken by M/s Om Ventures, a proprietary concern of the Director. The same has been taken over by the company at the time of takeover of assets & liabilities of Om ventures. The loan is secured by mortgage of the Director's immovable property. However as the loan continues to stand in the name of Director, the loan has been shown as unsecured loan in the books of the company. Further the interest of the loan and repayment of the loan is made by the company directly to the bank and the same is shown as the repayment of the Director's loan.

## Annexure

## STATEMENT OF LONG TERM PROVISIONS, AS RESTATED

(Rs. In lakhs)

Particulars	Financial Year Ended March		
	2022	2021	2020
Provision for gratuity	1.72	-	-
<b>Total</b>	<b>1.72</b>	<b>-</b>	<b>-</b>

## Annexure - IX

## STATEMENT OF SHORT TERM BORROWINGS, AS RESTATED

(Rs. In lakhs)

Particulars	Financial Year Ended March		
	2022	2021	2020
<b>Unsecured Loans</b>			
Current Maturities of long term debt	6.59	-	-
<b>Secured Loans</b>			
Canara Bank Cash Credit Account	187.00	-	-
<b>Total</b>	<b>193.59</b>	<b>-</b>	<b>-</b>

Canara Bank Cash Credit account is secured on stocks, receivables & other current assets of the Company and carries interest at 9.90%

## Annexure - X

## STATEMENT OF TRADE PAYABLE, AS RESTATED

(Rs. In lakhs)

Particulars	Financial Year Ended March		
	2022	2021	2020
Trade Payables			
a) Total outstanding dues of MSME	105.10	-	9.13
b) Total outstanding dues of creditots other than MSME	114.64	64.41	37.26
<b>Total</b>	<b>219.74</b>	<b>64.41</b>	<b>46.39</b>

**TRADE PAYABLE AGEING SCHEDULE**

Particulars	Outstanding for following periods from due date of payment#				
	Less than 1 year	1 to 2 years	2 to 3 years	More than 3 years	Total
(i) MSME	105.10				105.10
(ii) Others	114.64				114.64
(iii) Disputed dues – MSME					
<b>Total</b>	<b>219.74</b>	<b>-</b>	<b>-</b>	<b>-</b>	<b>219.74</b>

**Notes:-**

- Trade Payables have been taken as certified by the management of the company, balances are subject to party confirmations
- Segregation of trade payables as due to MSME and Other than MSME are certified by management.

**THE DISCLOSURES U/S 22 OF THE MICRO, SMALL AND MEDIUM ENTERPRISES DEVELOPMENT ACT, 2006**

The disclosures under the Micro, Small and Medium Enterprises Development Act, 2006 have been made on the basis of confirmations received from suppliers regarding their status under the said Act. The Company has not received any intimation from "suppliers" regarding their status under the Micro, Small and Medium Enterprises Development Act, 2006

Particulars	Amount in ₹
Outstanding principal amount and interest as on 31st December 2021	
- Principal Amount	105.10
- Interest due thereon	-
Amount of interest paid along with the amounts of payment made beyond the appointed day	-
Amount of interest due and payable (where the principal has already been paid but interest has not been paid)	-
The amount of interest accrued and remaining unpaid at the end of each accounting year	-
The amount of further interest remaining due and payable even in succeeding years, until such date when the interest dues as above are actually paid for the purpose of disallowance as a deductible expenditure under section 23 of the said Act	-

**Annexure -XI**
**STATEMENT OF OTHER CURRENT LIABILITIES, AS RESTATED**
*(Rs. In lakhs)*

Particulars	Financial Year Ended March		
	2022	2021	2020
Audit Fees Payable	1.13	0.25	0.25
Payment to statutory authorities	3.82	1.03	0.19
Provisions for Employee benefits	6.33	3.83	0.32
Other Liabilities	38.30	12.43	3.75
<b>Total</b>	<b>49.58</b>	<b>17.54</b>	<b>4.51</b>

**Annexure -XII**
**STATEMENT OF SHORT-TERM PROVISIONS, AS RESTATED**
*(Rs. In lakhs)*

Particulars	Financial Year Ended March		
	2022	2021	2020
Provision for Income Tax	31.66	11.78	1.16
Provision for Gratuity	13.52		
<b>Total</b>	<b>45.18</b>	<b>11.78</b>	<b>1.16</b>

Annexure- XIII  
STATEMENT OF FIXED ASSETS, AS RESTATED

(Rs. In lakhs)

Particulars	Financial Year Ended March		
	2022	2021	2020
<b>Furniture &amp; Fixture</b>			
Opening Balance	-	-	-
Addition during the year	3.29	-	-
Sale during the year	-	-	-
Depreciation during the year	0.42	-	-
Accumulated Depreciation	0.42	-	-
<b>Closing Balance</b>	<b>2.87</b>	-	-
<b>Plant and Machinery</b>			
Opening Balance	0.07	-	-
Addition during the year	17.76	0.07	-
Depreciation during the year	1.52	-	-
Accumulated Depreciation	1.53	0.01	-
<b>Closing Balance</b>	<b>16.30</b>	<b>0.06</b>	-
<b>Office Equipment</b>			
Opening Balance	0.20	-	-
Addition during the year	1.97	0.20	-
Depreciation during the year	0.54	0.03	-
Accumulated Depreciation	0.57	0.03	-
<b>Closing Balance</b>	<b>1.60</b>	<b>0.17</b>	-
<b>Computer and computer peripherals</b>			
Opening Balance	-	-	-
Addition during the year	0.65	-	-
Depreciation during the year	0.20	-	-
Accumulated Depreciation	0.20	-	-
<b>Closing Balance</b>	<b>0.45</b>	-	-
<b>Vehicles</b>			
Opening Balance	-	-	-
Addition during the year	3.05	-	-
Depreciation during the year	0.55	-	-
Accumulated Depreciation	0.55	-	-
<b>Closing Balance</b>	<b>2.50</b>	-	-
<b>Patterns &amp; Moulds</b>			
Opening Balance	-	-	-
Addition during the year	0.01	-	-
Depreciation during the year	-	-	-
Accumulated Depreciation	-	-	-
<b>Closing Balance</b>	<b>0.01</b>	-	-
<b>Intangible</b>			
Opening Balance	-	-	-
Addition during the year	20.69	-	-
Depreciation during the year	3.37	-	-
Accumulated Depreciation	3.37	-	-
<b>Closing Balance</b>	<b>17.32</b>	-	-
Total Tangible Asstes	27.00	0.27	-
Total Intangible Assets	20.69	-	-
Capital Work in Progress	-	-	-
Depreciation- Tangible Asstes	3.23	0.03	-
Depreciation- Intangible Assets	3.37	-	-
<b>Total Depreciation Charged during the year</b>	<b>6.60</b>	<b>0.03</b>	-
<b>Total accumulated Depreciation on Tangible Assets</b>	<b>3.27</b>	<b>0.03</b>	-
<b>Total accumulated Depreciation on Intangible Assets</b>	<b>3.37</b>	-	-
<b>WDV Tangible Asset (Net)</b>	<b>23.73</b>	<b>0.24</b>	-
<b>WDV Intangible Assets (Net)</b>	<b>17.32</b>	-	-



## Annexure - XIV

## STATEMENT OF OTHER NON-CURRENT ASSETS

(Rs. In lakhs)

Particulars	Financial Year Ended March		
	2022	2021	2020
Other Non Current Assets	28.95	2.04	0.20
<b>Total</b>	<b>28.95</b>	<b>2.04</b>	<b>0.20</b>

## Annexure - XV

## STATEMENT OF INVENTORIES, AS RESTATED

(Rs. In lakhs)

Particulars	Financial Year Ended March		
	2022	2021	2020
<b>Valued at Lower of Cost and Net Realisable Value</b>			
Raw Materials	14.26	14.09	5.98
Work in Progress	35.50	5.10	2.58
Finished Goods	68.49	25.81	2.56
<b>Total</b>	<b>118.25</b>	<b>45.00</b>	<b>11.12</b>

## Annexure - XVI

## STATEMENT OF TRADE RECEIVABLES, AS RESTATED

(Rs. In lakhs)

Particulars	Financial Year Ended March		
	2022	2021	2020
<b>Trade receivables outstanding for a period exceeding six months from the date they were due for payment</b>			
Secured, considered good	-	-	-
Unsecured, considered good	267.87	-	-
<b>Trade receivables outstanding for a period of less than six months from the date they were due for payment</b>			
Secured, considered good	441.77	64.71	30.19
Unsecured, considered good			
<b>Total</b>	<b>709.64</b>	<b>64.71</b>	<b>30.19</b>

Particulars	Outstanding for following periods from due date of payment					
	Less than 6 months	6 months - 1 year	1 to 2 years	2 to 3 years	More than 3 years	Total
(i) Undisputed Trade receivables – considered good	441.77	107.96	159.91	-	-	709.64
(ii) Undisputed Trade Receivables – considered doubtful						-
(iii) Disputed Trade Receivables considered good						-
(iv) Disputed Trade Receivables considered doubtful						-

## Notes:-

- Trade Receivables have been taken as certified by the management of the company. Balances of Trade Receivables are subject to balance confirmations
- As per the view of the management of the company there is no doubtful debt and hence provision for doubtful debts have not been made

## Annexure - XVII

## STATEMENT OF CASH &amp; BANK BALANCES, AS RESTATED

(Rs. In lakhs)

Particulars	Financial Year Ended March		
	2022	2021	2020
<b>Cash and Cash Equivalents</b>			
Cash-in-Hand	0.19	0.24	0.14
Balance with Banks	0.95	2.56	11.18
<b>Other Bank Balances</b>			
Balance in FD and RD	14.46	11.99	0.25
<b>Balances with Bank for other commitments</b>			
Fixed deposit for Performance guarantee and Bank guarantee	-	-	-
<b>Total</b>	<b>15.60</b>	<b>14.79</b>	<b>11.57</b>

## Annexure - XVIII

## STATEMENT OF SHORT TERM LOANS &amp; ADVANCES, AS RESTATED

(Rs. In lakhs)

Particulars	Financial Year Ended March		
	2022	2021	2020
Advances to Employees	0.21	0.11	0.01
Advances to Suppliers	4.41	1.99	1.02
<b>Total</b>	<b>4.62</b>	<b>2.10</b>	<b>1.03</b>

## Annexure - XIX

## OTHER CURRENT ASSETS

(Rs. In lakhs)

Particulars	Financial Year Ended March		
	2022	2021	2020
Advance Income Tax	-	-	-
GST receivable	7.79	-	-
Advance Tax, TDS, Other Tax Payments	1.79	0.62	-
Other Current Assets	-	2.88	1.05
<b>Total</b>	<b>9.58</b>	<b>3.50</b>	<b>1.05</b>

## Annexure - XX

## STATEMENT OF REVENUE FROM OPERATIONS, AS RESTATED

(Rs. In lakhs)

Particulars	Financial Year Ended March		
	2022	2021	2020
Sale of Finished Goods	787.49	255.46	27.31
Sale of Traded Goods	-	30.00	27.83
Sale of Services	18.47	9.34	1.67
<b>Total</b>	<b>805.96</b>	<b>294.80</b>	<b>56.81</b>

## Annexure - XXI

## STATEMENT OF OTHER INCOME, AS RESTATED

(Rs. In lakhs)

Particulars	Financial Year Ended March		
	2022	2021	2020
Interest received on Fixed Deposit / RD	0.55	0.29	-
Rent Income	1.00	-	-
Miscellaneous	0.04	0.14	0.02
<b>Total</b>	<b>1.59</b>	<b>0.43</b>	<b>0.02</b>

## Annexure - XXII

## STATEMENT OF RAW MATERIALS CONSUMED, AS RESTATED

(Rs. In lakhs)

Particulars	Financial Year Ended March		
	2022	2021	2020
Opening stock of Raw Materials	14.09	5.98	-
Add: Purchases	525.35	148.13	26.74
Direct Expenses	44.21	39.39	6.33
Less: Closing Stock of raw materials	(14.26)	(14.09)	(5.98)
<b>Total</b>	<b>569.39</b>	<b>179.41</b>	<b>27.09</b>

## Annexure - XXIII

## STATEMENT OF CHANGES IN INVENTORIES, AS RESTATED

(Rs. In lakhs)

Particulars	Financial Year Ended March		
	2022	2021	2020
Opening stock of Work in Progress	5.10	2.58	-
Opening Stock of Finished Goods	25.81	2.56	-
Closing stock of Work in Progress	(35.50)	(5.10)	(2.58)
Closing Stock of Finished Goods	(68.49)	(25.81)	(2.56)
<b>Total</b>	<b>(73.08)</b>	<b>(25.77)</b>	<b>(5.14)</b>

## Annexure - XXIV

## STATEMENT OF EMPLOYEE BENEFIT EXPENSES, AS RESTATED

(Rs. In lakhs)

Particulars	Financial Year Ended March		
	2022	2021	2020
Salaries, wages and bonus	73.09	37.26	0.71
Directors Remuneration	7.55	5.73	-
Contribution to Provident Fund, ESI and other Funds	4.98	2.50	-
Staff Welfare Expenses	2.35	1.73	0.13
Contribution to Gratuity	15.24	-	-
<b>Total</b>	<b>103.21</b>	<b>47.22</b>	<b>0.84</b>

## Annexure - XXV

## STATEMENT OF FINANCIAL COST, AS RESTATED

(Rs. In lakhs)

Particulars	Financial Year Ended March		
	2022	2021	2020
Interest paid on term loans	5.80	-	-
Other Interest & Finance Charges	9.82	-	-
<b>Total</b>	<b>15.62</b>	<b>-</b>	<b>-</b>

## Annexure

## STATEMENT OF OTHER EXPENSES, AS RESTATED

(Rs. In lakhs)

Particulars	Financial Year Ended March		
	2022	2021	2020
Advertisement Charges	1.10	0.11	0.07
Bank Charges	3.62	0.12	0.03
Corporate Social Responsibility	-	0.18	-
Freight Outward	11.86	6.47	0.75
Insurance	0.27	0.06	-
ISO Certification	-	0.06	-
Marketing and Sales Promotion Expenses	11.60	0.77	0.01
Miscellaneous Expenses	10.79	0.71	0.09
Membership Fees	0.46	0.06	-
Preoperative Expenses Written Off	-	0.46	-
Postage & Telephones	0.65	0.44	-
Printing & Stationery	0.77	0.14	0.02
Rent	13.65	0.53	0.08
Repairs & Maintenance	1.28	2.07	0.05
Registration & Renewals	3.76	0.65	0.03
Security Charges	1.77	1.77	0.29
Travelling Expenses	4.00	1.76	0.45
Professional Fees	2.28	3.17	1.00
Incorporation Expenses	-	-	0.35
Stamp & Postage	-	-	0.20
ROC Fees	0.10	0.01	0.06
Payment To Auditor	1.25	0.25	0.25
<b>Total</b>	<b>69.21</b>	<b>19.79</b>	<b>3.73</b>

**Annexure - XXVII**  
**STATEMENT OF CONTINGENT LIABILITIES, AS RESTATED**

(Rs. In lakhs)

Particulars	As on March 31,		
	2022	2021	2020
Bank Guarantees	-	-	-
<b>Total</b>	-	-	-

**Annexure - XXVIII**  
**STATEMENT OF DIVIDEND DECLARED, AS RESTATED**

(Rs. In lakhs)

Particulars	As on March 31,		
	2022	2021	2020
<b>On Equity Shares</b>			
Fully Paid up Share Capital (Rs. in lakhs)	117.75	5.00	5.00
Face Value (Rs.)	10.00	10.00	10.00
Paid up value per share (Rs.)	10.00	10.00	10.00
Rate of Dividend			
Total Dividend			
Corporate Dividend tax on above			

**Annexure - XXIX**  
**STATEMENT OF RELATED PARTY TRANSACTIONS, AS RESTATED**

The company has entered into following related party transactions for the periods covered under audit. Such parties and transactions are identified as per Accounting Standard 18 issued by Institute of Chartered Accountants of India:

**(i) Key Managerial Personnel & their relatives**

	As on March 31,		
	2022	2021	2020
Rajkumar Kamat	Rajkumar Kamat	Rajkumar Kamat	
Leena Kamat	-	-	
Nilam Naresh Kaddade	-	-	
Mohammad Faiyazul Haq	-	-	

**(ii) Associates / Enterprises over which any person described in (i) and (ii) is able to exercise significant influence**

	As on March 31,		
	2022	2021	2020
Om Venture	Om Venture	Om Venture	
E.P. Industries			
Omega Marketing			
Omega Engineers			
Business Nirvana Inc			
Epee Metal Goa Private Limited			

**(iii) Particulars of Transactions with Related Parties**

**Key Managerial Personnel & their relatives**

(Rs. In lakhs)

Particulars	As on March 31,		
	2022	2021	2020
<b>1) Expenses</b>			
Remuneration	15.59	5.73	-
Assets & Liabilities taken Over ( Net)	151.21		
<b>2) Money Received towards Share Capital</b>			
Equity Share Capital	80.25	-	4.70
<b>3) Outstanding</b>			
Payable	-	-	-
<b>4) Loans Taken</b>			
Opening Balance	-	0.25	-
Taken during the year	136.85	1.51	0.25
Interest during the year	-		
Repaid during the year	5.65	1.76	
Outstanding during the year	131.20	0.00	0.25

**(iii) Associates / Enterprises over which directors and / or their relatives has significant influence**

(Rs. In lakhs)

Particulars	As on March 31,		
	2022	2021	2020
<b>1) Sales/ Purchase</b>			
Sales	449.81	76.80	27.83
Purchases	120.55	4.13	9.24
<b>2) Expenses</b>			
Membership Fees	0.30	-	-
labour Charges	4.77	12.43	4.12
Rent	10.50	-	-
<b>3) Outstanding</b>			
Receivables	326.17	20.07	15.83
Interest on loan payable	5.80	-	-
<b>4) Incomes</b>			
Rent	1.00	-	-

**Annexure - XXXI**  
**STATEMENT OF CAPITALIZATION**

<b>Particular</b>	<b>Pre Issue ( as at March 31,2022)</b>	<b>Post Issue</b>
<b>Borrowing</b>		
Long Term Debt	217.52	137.52
Short Term Debt	193.59	193.59
<b>Total Debts (A)</b>	<b>411.11</b>	<b>331.11</b>
<b>Equity (Shareholder's funds)</b>		
Equity share capital	117.75	168.15
Reserve and Surplus	82.09	666.73
<b>Total Equity(B)</b>	<b>199.84</b>	<b>834.88</b>
<b>Long Term Debt/ Shareholders funds</b>	<b>1.09</b>	<b>0.17</b>
<b>Total Debts / Equity Shareholder's funds</b>	<b>2.06</b>	<b>0.41</b>

\*The above has been computed on the basis of restated financials

Annexure - XXX  
STATEMENT OF TAX SHELTERS AS RESTATED

(Rs. In lacs)

Particulars	Financial Year Ended		
	2022	2021	2020
<b>Tax Rates</b>			
Income Tax Rate (%)	22.00%	22.00%	22.00%
Surcharge	10.00%	10.00%	10.00%
	24.20%	24.20%	24.20%
Education Cess	4.00%	4.00%	4.00%
Income Tax Rate (%)	25.17%	25.17%	25.17%
Minimum Alternate Tax Rate (%)	15.60%	15.60%	15.60%
<b>Income from Business or Profession</b>			
Restated Profit before tax as per books (B)	<b>116.60</b>	<b>46.42</b>	<b>4.31</b>
<b>Income considered separately</b>			
Interest income			-
<b>Total income considered separately (C)</b>	-	-	-
<b>Timing Differences</b>			
Add : Incorporation Expenses	-	-	0.28
Add : Book Depreciation	6.60	0.03	-
Less : Income Tax Depreciation Allowance	8.68	0.03	-
<b>Total Timing Differences (D)</b>	<b>(2.08)</b>	<b>0.00</b>	<b>0.28</b>
<b>Permanent Differences</b>			
Add : Disallowable under Sec 36	0.59	0.28	-
Add : Disallowable under Sec 37	2.69	0.20	-
<b>Total Permanent Differences (E)</b>	<b>3.28</b>	<b>0.48</b>	-
<b>Income from Business or Profession (F) = (B-C+D+E)</b>	<b>117.80</b>	<b>46.91</b>	<b>4.59</b>
<b>Income from other sources</b>			
Interest income	-	-	-
<b>Total Income from other sources (G)</b>	-	-	-
<b>Deductions under Chapter VIA</b>			
Deduction under 80G	-	-	-
<b>Total Deductions under Chapter VIA (H)</b>	-	-	-
<b>Total Taxable income (A+F+G-H)</b>	<b>117.80</b>	<b>46.91</b>	<b>4.59</b>
<b>Income Tax on above</b>	29.65	11.81	1.16
<b>Book Profit for MAT</b>	116.60	46.42	4.31
<b>MAT on Book Profit</b>	18.19	7.24	0.67
Tax paid as per normal or MAT	NORMAL	NORMAL	NORMAL
Add: Interest Payable	2.01	1.98	0.33
Tax Payable	31.66	13.79	1.49
Tax Paid as per return	-	13.79	1.48
Difference	31.66	0.00	0.01

**STATEMENT OF ACCOUNTING RATIOS AS RESTATED**

(Rs. in lakhs except share data)

Particulars	For the year ended March 31,		
	2022	2021	2020
Restated PAT as per P & L Account	80.94	35.80	3.15
Actual Number of Equity Shares outstanding at the end of the year	1,177,500	50,000	50,000
Equivalent Weighted Avg number of Equity Shares at the end of the year	853,808	513,750	513,750
Diluted Weighted Avg number of potential Equity Shares at the end of the year	853,808	513,750	513,750
Share Capital	117.75	5.00	5.00
Reserves & Surplus	82.09	33.65	(2.15)
Misc. Expenses not w/off			
<b>Net Worth</b>	<b>199.84</b>	<b>38.65</b>	<b>2.85</b>
<b>Earnings Per Share (EPS):</b>			
Basic EPS	9.48	6.97	0.61
Diluted EPS	9.48	6.97	0.61
Return on Net Worth (%)	40.50%	92.63%	110.53%
Net Asset Value Per Share (Rs) - based on actual no. of equity shares at the end of the year	16.97	77.31	5.70
Nominal Value per Equity share (Rs.)	10.00	10.00	10.00

\* Not Annualised

**Notes to Accounting Ratios:**

a) The above statement should be read with the Significant accounting policies and notes to accounts appearing in Annexure IV & V respectively.

b) Formulas used for calculating above ratios are as under:

i. Basic EPS is being calculated by using the formula: ( Net Profit after excluding Extra-ordinary items / Equivalent Weighted Average No. of outstanding shares )

ii. Diluted EPS is being calculated by using the formula: ( Net Profit after excluding Extra-ordinary items / Equivalent Weighted Average No. of outstanding shares + potential no. of equity shares upon conversion of CCPS )

iii. Net Asset Value is being calculated by using the formula: ( Net Worth /Actual Number of Equity Shares at year end )

iv. Return on Net worth is being calculated by using the formula: ( Profit After Tax / Networth )

v. Net Tangible Assets comprises Net Fixed Assets and Net Working Capital.

Notes:

\* There is no revaluation reserve in last five years in our company.

\* As there is no dilutive capital in the company, Basic and Diluted EPS are similar.

\* Weighted Average No. of Equity Shares are calculated after giving effect for Bonus on 16th September 2021 and Rights Share Issue on 27th September 2021

## **MANAGEMENT DISCUSSION AND ANALYSIS OF FINANCIAL CONDITION AND RESULTS OF OPERATION**

You should read the following discussion and analysis of financial condition and results of operations together with our financial statements included in this Prospectus. The following discussion relates to our Company and is based on our restated financial statements. Our financial statements have been prepared in accordance with Indian GAAP, the accounting standards and other applicable provisions of the Companies Act.

Note: Statement in the Management Discussion and Analysis Report describing our objectives, outlook, estimates, expectations or prediction may be "Forward looking statement" within the meaning of applicable securities laws and regulations. Actual results could differ materially from those expressed or implied. Important factors that could make a difference to our operations include, among others, economic conditions affecting demand/supply and price conditions in domestic and overseas market in which we operate, changes in Government Regulations, Tax Laws and other Statutes and incidental factors.

### **BUSINESS OVERVIEW**

Our company was incorporated on 17 January 2020 and is into manufacturing and supply of fibre re-inforced polymers (FRP) products such as door shutters, frames, Biodigester Tanks, Bio toilets and allied products for construction and Industrial applications which meets customer requirements. The company has taken over the running business of our promoter, 'M/s Om Ventures', a sole proprietorship through a business transfer agreement dated August 31, 2021. For further details please refer to "History and other corporate matters" beginning on page no. 113 of this Prospectus.

We focus on giving sanitation solutions to those who do not have access to toilets, as well as to those who have toilets but face trouble treating and managing the waste. We provide sanitation infrastructure and human waste management solutions and services, involving innovative and simple bio-digester technology licensed from Defence Research and Development Organisation (DRDO) and Industry Interface and Technology Management, operating under the aegis of DRDO, Ministry of Defence, and Government of India. The anaerobic bio-digester technology helps users manage waste onsite, without depending on expensive and energy-consuming sewage infrastructure. The Sewage Treatment Plant helps contaminant concentrations to be lowered to a safe level before wastewater can be reused or returned to the environment. The effluent water treatment - a technique used for processing industrial wastewater for reuse or safe discharge to the environment. The company also specializes in FRP allied products. FRP which stands for Fiber Reinforced Polymer is an eco-friendly substitute for wood that has long been the chosen building material - a limited resource that has resulted in major environmental problems, such as fast forest decline.

The company has supplied more than 2,00,000 FRP doors thereby saving more than thousands of trees and 2500 Bio Toilets to household helping reduction to open defecation thereby contributing to clean and green surroundings. For our innovation and continuous contribution for betterment of society, we as a group have been recognized and acclaimed with the National Award for Outstanding Efforts in Entrepreneurship in MSEs (Manufacturing).

Our revenue from operations was Rs 805.96, Rs 294.80 lakhs and Rs 56.81 lakhs for Fiscal 2022, 2021 and 2020 respectively. It may be noted that, despite pandemic the company has been growing exponentially

Our EBITDA was Rs 116.60, Rs 46.42 lakhs and Rs 4.31 lakhs for Fiscal 2022, 2021 and 2020 respectively. Our restated profit after tax was Rs80.94, Rs 35.80 lakhs and Rs 3.15 lakhs for Fiscal 2022, 2021 and 2020 respectively.



## Our Strengths



## Significant Developments after Sep 30, 2021 that may affect our Future Results of Operations

The Directors confirm that there have been no events or circumstances since the date of the last financial statements as disclosed in the Prospectus which materially or adversely affect or is likely to affect the profitability of our Company, or the value of our assets, or our ability to pay liabilities within next twelve months.

## RECENT DEVELOPMENT

### *Impact of COVID-19*

Since the onset of the COVID-19 pandemic in March 2020, our Company has responded swiftly by implementing various processes to ensure our operations continue seamlessly. In 2020, cases of the novel corona virus started rapidly increasing in India, which led the government of India to impose a nationwide lockdown. The spread of Covid-19 and its recent developments have had and might continue to have repercussions across local, national and global economies. We are engaged in the manufacturing and supply of fibre re-inforced polymers (FRP) products such as door shutters, frames, Biodigestor Tanks, Bio toilets & allied products for construction and industrial applications. A strong base of loyal customers and diversified product range caters to multiple customer segments like Hotels, Industry, Government besides Individuals & construction sector helped us continue our operations inspite of Covid. An Increase in Raw material prices due to its shortage in the market has affected our operations. Average of nearly 15% increase in raw material costs has impacted our bottom line, through the Top line has grown healthily. We continued our operations after making arrangements to meet the government's requirements on sanitization, people movement and social distancing. However the prices are now slowly falling in places with economy opening up.

We consider that our swift response and proactive steps taken have mitigated the impact of COVID- 19 pandemic on our business and personnel thus far. And we were able to remain growth oriented and profit oriented. The future impact of COVID-19 or any other severe communicable disease on our business and results of operations depends on several factors including those discussed in "Risk Factors" on page 19 of this Prospectus. We are continuously monitoring the economic conditions and have outlined certain measures to combat the pandemic situation and to minimize the impact on our business. For more details, see Risk Factors Affecting Results of Operations and Financial Condition – COVID-19 Pandemic on page 19 of this Prospectus

## FACTORS AFFECTING OUR RESULT OF OPERATIONS

Except as otherwise stated in the Prospectus and the Risk Factors given in the Prospectus, the following important factors could cause actual results to differ materially from the expectations include, among others:

**1. *Some of our solutions are license based; any failure on our part to successfully retain the license would have a material adverse effect on our operation and profitability.***

Some of our sanitation solutions are based on the patented “bio-digester” technology developed by DRDO (Defence Research and Development Organization). We are a licensee (through transfer of technology) and have partnered DRDO for technology commercialization for large-scale deployment of sanitation systems. Though the license is perpetual in nature, any failure on our part to retain the license could materially affect our business. Further any subsequent introduction of royalty claimed by DRDO will increase our cost and adversely affect our profitability as currently there is no royalty levied by DRDO on the product sale.

**2. *Some of the immovable properties used by us are on lease and leave and license basis. If we are unable to renew existing lease and leave and license or relocate operations on commercially reasonable terms, there may be an effect on our business, results of operations and prospects.***

We do not own the premises from where we operate. We have entered into sub lease agreements for our manufacturing unit/registered office at Plot No 57, Shed No D-2/12, Bicholim Industrial Estate, Bicholim, Goa 403504. This agreement is renewable based on the terms of the agreement. We also have entered into Leave and License agreement for our corporate office dated 31<sup>st</sup> December 2021 w.e.f. 1<sup>st</sup> January 2022. This agreement is renewable based on terms of agreement. Further, if we are unable to renew the agreements pursuant to which we occupy the premises on terms and conditions acceptable to us, or at all, we may have to relocate to other places and if we relocate our manufacturing unit, registered office or Corporate Office as a result of any termination or non-renewal of our leases and rentals, we may incur additional cost as a result of such relocation. Any failure or difficulty faced by us in renewing leases, or disputes or other problems that we may face in the future with lessors may affect our business and prospects. For further details of our Properties, please refer to section titled “Our Business” beginning on Page no. 72 of this Prospectus.

**3. *Our Company has availed unsecured loan from our Directors / Promoters which is repayable on demand.***

Any demand from the lender for repayment of such unsecured loan may affect our cash flow and financial condition. Our Company, as per the restated financial statement as on March 31, 2022 has availed unsecured loans of Rs 224.01 lakhs out of which loan of Rs. 92.91 lakhs from Director carries interest@ 10.50% and is repayable in 120 EMIs. Further, Loan of 131.10 availed from Mr Rajkumar Kamat is an interest free loan and no terms of repayment have been stipulated. Sudden recall may disrupt our operations and also may force us to opt for high interest bearing funding, resulting in financial burden. Further, we will not be able to raise funds at short notice and thus result in shortage of working capital fund. For further details, please refer to the section “Unsecured Loans” under “Financial Statements” beginning on page no.121 of this Prospectus. Any demand for the repayment of such unsecured loans, may adversely affect our cash flow and financial condition.

**4. *Substantial portion of our revenue has been dependent upon our few clients. The loss of any one or more of our major clients would have a material effect on our business operations and profitability.***

Our customers include large corporate houses, trust & Industries. For the financial year ended March 31, 2022 and March 31, 2021, our top ten clients accounted for approximately 68.92% and 43.79% of our revenue from operations. The loss of any significant client would have a material effect on our financial results. We cannot assure you that we can maintain the historical levels of business from these clients/distributors or that we will be able to replace these clients/distributors in case we lose any of them. Furthermore, major events affecting our clients, such as changes in government policies and bankruptcy, change of management, mergers and acquisitions in other cases could impact our business. If any of our major client becomes bankrupt or insolvent, we may lose some or all of our business from that client and our receivable from that client would increase and may have to be written off, impacting our income and financial condition.

***General economic and business conditions***

As a Company with its complete operations in India, we are affected by general economic conditions in the country and in particular economic factors that affect pharmaceutical industry in India. India's gross domestic product, or GDP, has been and will continue to be of importance in determining our operating results and future growth.

**RESULTS OF OUR OPERATIONS**
*(₹ in lakhs)*

Particulars	For the year ended March 31,					
	2022	% of Total Income	2021	% of Total Income	2020	% of Total Income
<b>INCOME:</b>						
Revenue from Operations	805.96	99.80%	294.80	99.85%	56.81	99.96%
Other Income	1.59	0.20%	0.43	0.15%	0.02	0.04%
<b>Total income (A)</b>	<b>807.55</b>	<b>100.00%</b>	<b>295.23</b>	<b>100.00%</b>	<b>56.83</b>	<b>100.00%</b>
<b>EXPENSES:</b>						
Cost of Materials Consumed	569.39	70.51%	179.41	60.77%	27.09	47.67%
Changes in inventories	(73.08)	-9.05%	(25.77)	-8.73%	(5.14)	-9.04%
Trading goods purchases	-	0.00%	28.13	9.53%	26.00	45.75%
Employee benefit expenses	103.21	12.78%	47.22	15.99%	0.84	1.48%
Other Expenses	69.21	8.57%	19.79	6.70%	3.73	6.56%
Finance costs	15.62	1.93%	-	0.00%	-	0.00%
Depreciation	6.60	0.82%	0.03	0.01%	-	0.00%
<b>Total Expenses (B)</b>	<b>690.95</b>	<b>85.56%</b>	<b>248.81</b>	<b>84.28%</b>	<b>52.52</b>	<b>92.42%</b>
<b>Net Profit / (Loss) before tax</b>	<b>116.60</b>	<b>14.44%</b>	<b>46.42</b>	<b>15.72%</b>	<b>4.31</b>	<b>7.58%</b>
<b>Less: Tax expense</b>						
(i) Current tax	31.66	3.92%	10.62	3.60%	1.16	2.04%
(ii) Prior Period Tax	3.48	0.43%				
(iii) Deferred tax	0.52	0.06%	0.00	0.00%	-	0.00%
<b>Total Tax Expense</b>	<b>35.66</b>	<b>4.42%</b>	<b>10.62</b>	<b>3.60%</b>	<b>1.16</b>	<b>2.04%</b>
<b>Net Profit / ( Loss ) after tax</b>	<b>80.94</b>	<b>10.02%</b>	<b>35.80</b>	<b>12.13%</b>	<b>3.15</b>	<b>5.54%</b>

## ***Main Components of our Profit and Loss Account***

### **Income**

Our total income comprises of revenue from operations and other income.

#### *Revenue from Operations*

Our revenue from operations as a percentage of total income was 99.80%, 99.85%, and 99.96%, for the fiscals 2022, 2021 and 2020 respectively.

#### *Other Income*

Our other income comprises of interest income and rental. Other income, as a percentage of total income was 0.20%, 0.15% and 0.04%, for the fiscals 2022, 2021 and 2020 respectively.

### **Expenditure**

Our total expenditure primarily consists of raw material consumed, Change in Inventories of WIP & Finished Goods, Traded goods purchases, employee benefit expenses, finance cost, depreciation expenses and other expenses.

#### *Cost of Raw Material Consumed*

It consists of cost of raw materials consumed.

#### *Changes in Inventories*

Consists of changes in work-in-progress and finished products, if any.

#### *Employee Benefit Expenses*

Employee benefit expenses comprises of salaries, staff welfare expenses, contribution to PF & Gratuity and director's remuneration.

#### *Trading Goods Purchased*

Consists of traded goods.

#### *Depreciation and Amortization Cost*

Depreciation and Amortization Expenses consist of depreciation on the Tangible assets of our company i.e. Furniture, Plant & Machinery, Computer, Office Equipment, Factory, Office Building, Vehicle and Amortization expense on Intangible Asset i.e. Technical Know How.

#### *Finance costs*

Finance cost includes Interest on Borrowings.

#### *Other Expenses*

Other expenses include advertisement expenses, insurance expense, freight, travelling expenses, printing and stationery expenses, telephone expenses, audit fees, security charges, Rent expenses, postage and telephone expenses, repairs and maintenance expenses and other miscellaneous expenses.

#### *Provision for Tax*

The provision for current taxation is computed in accordance with relevant tax regulation. Deferred tax is recognized on timing differences between the accounting and the taxable income for the year and quantified using the tax rates and laws enacted or subsequently enacted as on balance sheet date. Deferred tax assets are recognized and carried forward to the

extent that there is a virtual certainty that sufficient future taxable income will be available against which such deferred tax assets can be realized in future.

## **Fiscal 2022 compared with fiscal 2021**

### *Income*

In fiscal 2022, our total income increased by ₹ 512.32 lakhs or 173.53%, from ₹295.23 lakhs in fiscal 2021 to ₹ 807.55 lakhs in fiscal 2022. The increase in the year 2022 was due to increase in the sale of finished goods, traded goods and sale of services as compared to last year.

Other income increased by ₹ 1.16 lakhs or 269.77%, from ₹ 0.43 lakhs in fiscal 2021 to ₹ 1.59 lakhs in fiscal 2022.

### *Cost of Material Consumed*

Cost of material consumed increased by ₹ 389.98 lakhs or 217.37%, from ₹ 179.41 lakhs in Fiscal 2021 to ₹ 569.39 lakhs in Fiscal 2022.

### *Change in Inventory*

Changes in Inventories shows a variance of 183.59% from negative ₹ 25.77 lakhs in Fiscal 2021 to negative ₹ 73.08 lakhs in Fiscal 2022.

### *Trading Goods Purchases*

Trading Goods Purchases decreased by ₹28.12 lakhs or 100.00% from ₹28.13 lakhs in fiscal 2021 to ₹0.00 lakhs in fiscal 2022. The decrease is mainly due to Nil trading of goods.

### *Employee Benefit Expenses*

Employee Benefit Expenses increased by ₹ 55.99 lakhs or 118.59%, from ₹ 47.22 lakhs in fiscal 2021 to ₹ 103.21 lakhs in fiscal 2022. This increase was mainly due to increase in salaries wages and bonus and staff welfare expenses, contribution to Gratuity & PF as compared to last fiscal.

### *Depreciation Expenses*

Depreciation expenses were 6.60 lakhs in fiscal 2022. Additional Fixed Assets were purchased in fiscal 2022.

### *Other Expenses*

Other expenses increased by ₹49.42 lakhs or 249.72 % from ₹ 19.79 lakhs in fiscal 2021 to ₹ 69.21 lakhs in Fiscal 2022. The increase was majorly due to increase in certain expense like advertisement expenses, insurance expense, freight, travelling expenses, printing and stationary expenses, telephone expenses, and other miscellaneous expenses.

### *Profit/ (Loss) before Tax*

The increase in revenue from operations has led to increase in our Profit before tax by ₹ 70.18 lakhs or 151.17 % from ₹ 46.42 lakhs in fiscal 2021 to ₹ 116.60 lakhs in fiscal 2022.

### *Tax Expenses*

The Company's tax expenses had increased by ₹ 21.04 lakhs or 198.12 % from ₹ 10.62 lakhs in the Fiscal 2021 to ₹ 31.66 lakhs in Fiscal 2022 due to increase in profits.

### *Profit/ (Loss) after Tax*

After accounting for taxes at applicable rates, our Profit after Tax increased by ₹ 45.14 lakhs or 126.08 %, from ₹ 35.80 lakhs in fiscal 2021 to ₹ 80.94 lakhs in fiscal 2022.

## Fiscal 2021 compared with fiscal 2020

### *Income*

In fiscal 2021, our total income increased by ₹ 238.40 lakhs or 419.50%, from ₹ 56.83 lakhs in fiscal 2020 to ₹ 295.23 lakhs in fiscal 2021. The increase in the year 2021 was due to increase in the sale of finished goods, traded goods and sale of services as compared to last year.

Other income increased by ₹ 0.41 lakhs or 2050.00%, from ₹ 0.02 lakhs in fiscal 2020 to ₹ 0.43 lakhs in fiscal 2021.

### *Cost of Material Consumed*

Cost of material consumed increased by ₹ 152.32 lakhs or 562.27%, from ₹ 27.09 lakhs in Fiscal 2020 to ₹ 179.41 lakhs in Fiscal 2021.

### *Change in Inventory*

Changes in Inventories shows a variance of 401.36% from negative ₹ 5.14 lakhs in Fiscal 2020 to negative ₹ 25.77 lakhs in Fiscal 2021.

### *Trading Goods Purchases*

Trading Goods Purchases increased by ₹2.13 lakhs or 8.19% from ₹26.00 lakhs in fiscal 2020 to ₹28.13 lakhs in fiscal 2021. The increase was mainly due to increase in purchases.

### *Employee Benefit Expenses*

Employee Benefit Expenses increased by ₹ 46.38 lakhs or 5,521.02%, from ₹ 0.84 lakhs in fiscal 2020 to ₹ 47.22 lakhs in fiscal 2021. This increase was mainly due to increase in salaries wages and bonus and staff welfare expenses as compared to last fiscal.

### *Depreciation Expenses*

Depreciation expenses were 0.03 lakhs in fiscal 2021. Fixed Assets were purchased in fiscal 2021.

### *Other Expenses*

Other expenses increased by ₹ 16.06 lakhs or 430.56 % from ₹ 3.73 lakhs in fiscal 2020 to ₹ 19.79 lakhs in Fiscal 2021. The increase was majorly due to increase in certain expense like advertisement expenses, insurance expense, freight, travelling expenses, printing and stationery expenses, telephone expenses, and other miscellaneous expenses.

### *Profit/ (Loss) before Tax*

The increase in revenue from operations has led to increase in our Profit before tax by ₹ 42.11 lakhs or 977.11 % from ₹ 4.31 lakhs in fiscal 2020 to ₹ 46.42 lakhs in fiscal 2021.

### *Tax Expenses*

The Company's current tax expenses had increased by ₹ 9.46 lakhs or 815.52 % from ₹ 1.16 lakhs in the Fiscal 2020 to ₹10.62 lakhs in Fiscal 2021 due to increase in profits.

### *Profit/ (Loss) after Tax*

After accounting for taxes at applicable rates, our Profit after Tax increased by ₹ 32.65 lakhs or 1,036.59 %, from ₹ 3.15 lakhs in fiscal 2020 to ₹ 35.80 lakhs in fiscal 2021.

## Cash Flows

(₹ in lakhs)

Particulars	For the year ended March 31		
	2022	2021	2020
Net Cash from Operating Activities	(429.11)	3.31	11.62



Particulars	For the year ended March 31		
	2022	2021	2020
Net Cash from Investing Activities	(45.82)	0.16	-
Net Cash used in Financing Activities	475.74	(0.25)	(0.05)
<b>Net Increase / (Decrease) in Cash and Cash equivalents</b>	<b>(0.81)</b>	<b>3.22</b>	<b>11.57</b>

### ***Cash Flows from Operating Activities***

Net cash from operating activities for the fiscal 2022 was negative ₹ 429.11 lakhs as compared to the PBT of ₹ 116.60 lakhs for the same period. This difference is primarily on account of changes in trade and other receivables, trade and other payables, other current liabilities, short term loans and advances, long term loans and advances, inventories and other current assets.

Net cash from operating activities in fiscal 2021 was ₹ 3.31 lakhs as compared to the PBT of ₹ 46.42 lakhs for the same year. This difference is primarily on account of changes in trade and other receivables, trade and other payables, other current liabilities, short term provisions/borrowing, short term loans and advances, long term loans and advances and inventories.

Net cash from operating activities in fiscal 2020 was ₹ 11.62 lakhs as compared to the PBT of ₹ 4.31 lakhs for the same year. This difference is primarily on account of changes in trade and other receivables, trade and other payables, other current liabilities, short term provisions/borrowing, short term loans and advances and inventories.

### ***Cash Flows from Investment Activities***

In fiscal 2022 the net cash invested in investing activities was negative ₹ 45.82 lakhs. This was majorly on account of fixed assets transferred through the Business Transfer Agreement and interest received.

In fiscal 2021, the net cash generated from investing activities was ₹ 0.16 lakhs. This was majorly on account of purchase of fixed assets and interest received.

In fiscal 2020, the net cash invested/generated in Investing Activities was NIL.

### ***Cash Flows from Financing Activities***

Net cash from financing activities in fiscal 2022 was ₹ 475.74 lakhs. This was on account of proceeds from borrowing, proceeds from issue of share capital.

Net cash from financing activities in fiscal 2021 was negative ₹ 0.25 lakhs. This was on account of repayments of borrowing.

Net cash from financing activities in fiscal 2020 was negative ₹ 0.05 lakhs. This was on account of proceeds/repayments from borrowing, proceeds from issue of share capital and IPO Expenses.

### ***OTHER MATTERS***

#### **1. Unusual or infrequent events or transactions**

Except as described in this Prospectus, during the period/ years under review there have been no transactions or events, which in our best judgment, would be considered unusual or infrequent.

#### **2. Significant economic changes that materially affected or are likely to affect income from continuing Operations**

Other than as described in the Section titled “*Financial Information*” and chapter titled “*Management’s Discussion and Analysis of Financial Conditions and Results of Operations*” on page 121 and 141 respectively of this Prospectus respectively, to our knowledge there are no significant economic changes that materially affected or are likely to affect income from continuing Operations.

**3. Known trends or uncertainties that have had or are expected to have a material adverse impact on revenue or income from continuing operations**

Other than as described in the chapter titled “*Risk Factors*” and “*Management’s Discussion and Analysis of Financial Conditions and Result of Operations*” on page 19 and 141 respectively of this Prospectus respectively, best to our knowledge there are no known trends or uncertainties that have or had or are expected to have a material adverse impact on revenues or income of our company from continuing operations.

**4. Future relationship between Costs and Income**

Other than as described in the chapter titled “*Risk Factors*” on page 19 of this Prospectus, best to our knowledge there are no factors, which will affect the future relationship between costs and income or which are expected to have a material adverse impact on our operations and finances.

**5. The extent to which material increases in revenue or income from operations are due to increased volume, introduction of new services or increased prices**

Increase in revenues are by and large linked to increase in volume of business activity thereby, serving more customers.

**6. Status of any publicly announced new services or business segments**

Please refer to the chapter titled “*Our Business*” on page 72 of this Prospectus.

**7. The extent to which the business is seasonal.**

Our business is not seasonal in nature.

**8. Any significant dependence on a single or few suppliers or customers**

The revenues from our top 5 and top 10 customers constituted approximately 39.35 % and 43.79 % respectively for Fiscal 2021. For fiscal 2022, the revenue from our top 5 and top 10 customers constituted approximately 65.83 % and 68.92% respectively of the revenue from operations. For further details, please refer chapter “*Our Business*” on page 72 of this Prospectus.

**9. Competition Conditions**

We face competition from various domestic and other players in the market. Most of our competitors in the regional level are from the unorganized sector of the industry. We intend to continue competing vigorously to capture more market share and manage our growth in an optimal way. We expect that our commitment to quality, past record of timely execution and transparency will provide us with an edge over our competitors. Further we believe that our competition also depends on several factors which include changing business framework, competitive price, and established relationship with suppliers, brand recognition etc. We are one of the few companies manufacturing FRP Doors and Bio Digester Toilets in the Organized Sector. With the introduction of GST, unorganized market is shrinking at faster rate than before and organized companies like ours can expand rapidly in collaboration with local entrepreneurs in other areas. The focus will be on expanding to the huge untapped markets in India and abroad as substantial part of the funds will be utilized to strengthen this aspect. We therefore believe that we will be able to grow healthily despite competition.

## FINANCIAL INDEBTEDNESS

Our Company has availed borrowings in the ordinary course of our business. Set forth below is a brief summary of our aggregate outstanding borrowings as on March 31, 2022:

*(Rs. in lakhs)*

Nature of Borrowing	Amount
Secured Borrowings	187.00
Unsecured Borrowings	224.11
<b>Total</b>	<b>411.11</b>

### A. Details of Secured Loans

*(Rs. in lakhs)*

Name of Lenders	Sanction Letter Date	Nature of the Facility	Amount Sanctioned	Amount outstanding as on March 31, 2022	Interest Rate and Security
Canara Bank	27 <sup>th</sup> August 2021	Cash Credit	196.00	187.00	Note 1

### Interest Rate and Security Details

Particulars	Interest Rate	Security Details
Note 1	6.90% (RLLR is 6.90%) + 3.00% (Spread for Normal risk for collateral coverage upto 50%)	<p><b>Security</b></p> <ul style="list-style-type: none"> <li>• Hypothecation of stock and book debts</li> </ul> <p><b>Collateral securities</b></p> <ul style="list-style-type: none"> <li>• EMT of Shop/Unit No A/G -14, Ground Floor, Campal Trade Centre, Campal, Panaji, admrng 25.75 Sq.Mtrs in the name of M/s EP Industries( Proprietor firm of Rajkumar Kamath)</li> </ul> <p><b>Personal Guarantee:</b></p> <ul style="list-style-type: none"> <li>• Rajkumar Gajanan Kamat</li> <li>• Mrs Leena R Kamath</li> </ul>

### B. Details of Unsecured Borrowings

Our Company availed unsecured loans as on March 31, 2022; details of which are set out below:

*(Rs. in lakhs)*

Name of Lenders	Amount outstanding as on March 31, 2022
<b>From Directors</b>	
Rajkumar Kamat	131.10
Leena Kamat	92.91
<b>Total</b>	<b>224.01</b>

**Note:** Loan from Leena Kamat carries interest @ 10.50% and is repayable in 120 EMIs. The other loan is interest free.

## SECTION VII – LEGAL AND OTHER REGULATORY INFORMATION

### OUTSTANDING LITIGATIONS AND MATERIAL DEVELOPMENTS

Except as stated in this section, there are no:

A. (i) criminal proceedings; (ii) actions by statutory or regulatory authorities; (iii) claims relating to direct and indirect taxes; or (iv) Material Litigation (as defined below); involving our Company, Directors or Promoter. Our Board, in its meeting held on January 11, 2022 determined that all litigations pertaining to the company, its directors/promoter/group companies which are in the nature of criminal, statutory/regulatory and taxation related are deemed material by the Board. Further, the Board considers all other litigation pertaining to the company, its directors/promoter/group companies which are above a claim amount equal to or exceeding 10 Lakhs as material litigation (“Material Litigation”).

B. Disciplinary actions including penalty imposed by SEBI or stock exchanges against the Promoter in the last 5 (five) Financial years including outstanding action.

C. (i) outstanding Material Dues (as defined below) to creditors; or (ii) outstanding dues to small scale undertakings and other creditors.

Our Board, in its meeting held on January 11, 2022 determined that all outstanding dues owed by the Company to small scale undertaking and other creditors exceeding 5% of the revenue of our Company as per the audited previous full year financial statements are considered as material by our Board and the same will be disclosed in the Annual report of the Company. Details of outstanding dues to creditors(including micro and small enterprises as defined under the Micro, Small and Medium Enterprises Development Act, 2006) as required under the SEBI ICDR Regulations have been disclosed on our website at [www.epbiocomposites.com](http://www.epbiocomposites.com)

Our Company, Directors and Promoter are not Wilful Defaulter or a Fraudulent Borrower.

#### LITIGATION INVOLVING OUR COMPANY

##### **A. LITIGATION AGAINST OUR COMPANY**

###### **1. Criminal matters**

NIL

###### **2. Litigation Involving Actions by Statutory/Regulatory Authorities**

NIL

###### **3. Litigation involving Tax Liabilities**

###### **(i) Direct Tax Liabilities**

NIL

###### **(ii) Indirect Taxes Liabilities**

NIL

###### **4. Other Pending Litigations**

NIL

##### **B. LITIGATION FILED BY OUR COMPANY**

###### **1. Litigation Involving Criminal matters**

NIL

**2. Litigation Involving Actions by Statutory/Regulatory Authorities**

NIL

**3. Litigation involving Tax Liabilities**

**(i) Direct Tax Liabilities**

NIL

**(ii) Indirect Taxes Liabilities**

NIL

**4. Other Pending Litigations**

NIL

**LITIGATION INVOLVING OUR DIRECTORS**

**A. LITIGATION AGAINST OUR DIRECTORS**

**1. Criminal matters**

NIL

**2. Litigation Involving Actions by Statutory/Regulatory Authorities**

NIL

**3. Litigation involving Tax Liabilities**

**(i) Direct Tax Liabilities**

NIL

**(ii) Indirect Taxes Liabilities**

NIL

**4. Other Pending Litigations**

NIL

**B. LITIGATION FILED BY OUR DIRECTORS**

**1. Litigation Involving Criminal matters**

NIL

**2. Litigation Involving Actions by Statutory/Regulatory Authorities**

NIL

**3. Litigation involving Tax Liabilities**

**(i) Direct Tax Liabilities**

NIL

**(ii) Indirect Taxes Liabilities**

NIL

**4. Other Pending Litigations**

NIL

**LITIGATION INVOLVING OUR PROMOTER**

**A. LITIGATION AGAINST OUR PROMOTER**

**1. Litigation Involving Criminal matters**

NIL

**2. Litigation Involving Actions by Statutory/Regulatory Authorities**

NIL

**3. Litigation involving Tax Liabilities**

**(i) Direct Tax Liabilities**

NIL

**(ii) Indirect Tax Liabilities**

NIL

**4. Other Pending Litigations**

NIL

**B. LITIGATION FILED BY OUR PROMOTER**

**1. Litigation Involving Criminal matters**

NIL

**2. Litigation Involving Actions by Statutory/Regulatory Authorities**

NIL

**3. Litigation involving Tax Liabilities**

**(i) Direct Tax Liabilities**

NIL

**(ii) Indirect Taxes Liabilities**

NIL

**4. Other Pending Litigations**

NIL

## **LITIGATION INVOLVING GROUP COMPANIES**

### **A. LITIGATION AGAINST OUR GROUP COMPANIES**

#### **1. Litigation involving Criminal matters**

NIL

#### **2. Litigation Involving Actions by Statutory/Regulatory Authorities**

NIL

#### **3. Litigation involving Tax Liabilities**

##### **(i) Direct Tax Liabilities**

NIL

##### **(ii) Indirect Taxes Liabilities**

NIL

#### **4. Other Pending Litigations**

NIL

### **B. LITIGATION FILED BY OUR GROUP COMPANIES**

#### **1. Criminal matters**

NIL

#### **2. Litigation Involving Actions by Statutory/Regulatory Authorities**

NIL

#### **3. Litigation involving Tax Liabilities**

##### **(i) Direct Tax Liabilities**

NIL

##### **(ii) Indirect Taxes Liabilities**

NIL

#### **4. Other Pending Litigations**

NIL

### **Amounts owed to small scale undertakings and other creditors**

As of March 31, 2022, our Company owes the following amounts to small scale undertakings, other creditors and material creditors:

<b>Particulars</b>	<b>Number of Creditors</b>	<b>Amount involved (Rs. in lakhs)</b>
Micro, Small and Medium Enterprise	17	105.10
Material Creditors	34	102.52
Other Creditor	29	12.12
<b>Total Creditors</b>	<b>80</b>	<b>219.74</b>



Details in relation to the amount owed by our Company to material creditors, small scale undertakings and other creditors as on September 30, 2021 are also available on [www.epkamatgroup.com](http://www.epkamatgroup.com).

It is clarified that information provided on the website of our Company is not a part of this Prospectus and should not be deemed to be incorporated by reference. Anyone placing reliance on any other source of information, including our Company's website, would be doing so at its own risk.

**Disciplinary action including penalty imposed by SEBI or stock exchanges against the promoter in the last five financial years**

There are no disciplinary actions including penalty imposed by SEBI or Stock Exchanges against the Promoter during the last 5 financial years including outstanding actions.

**Material developments occurring after last balance sheet date**

Except as disclosed elsewhere in this Prospectus, there have been no material developments that have occurred after the Last Balance Sheet Date.

## GOVERNMENT AND OTHER KEY APPROVALS

*Our Company can undertake the Issue and our Company and Subsidiaries can undertake their respective current business activities, including on the basis of the list of material approvals provided below, and other than as stated below, no further material approvals from any regulatory authority are required to undertake the Issue or continue such business activities. Unless otherwise stated, these material approvals are valid as of the date of this Draft Red Herring Prospectus.*

### I. APPROVALS FOR THE ISSUE

The Board of Directors have, pursuant to Section 62(1)(c) and other applicable provisions of the Companies Act, 2013, by a resolution passed at its meeting held on January 7, 2022 authorized the Issue, subject to the approval of the shareholders and such other authorities as may be necessary.

The shareholders of our Company have, pursuant to Section 62(1)(c) of the Companies Act, 2013, by special resolution passed in the extra ordinary general meeting held on January 10, 2022 authorized the Issue.

In-principle approval dated March 10, 2022 from the BSE SME for listing of the Equity Shares issued by our Company pursuant to the Issue.

Our Company's International Securities Identification Number (“ISIN”) is INE0D2I01014

### II. APPROVALS PERTAINING TO INCORPORATION

#### a. Approvals obtained by the Company

- i. Certificate of Incorporation dated January 17, 2020 issued under the name EP Biocomposites Limited by Registrar of Companies.
- ii. The Corporate Identity Number of the Company is U28900GA2020PLC014240

### III. TAX AND LABOUR RELATED APPROVALS

#### a. Approvals obtained by the Company

Sr. No.	Description	Registration / Approval / Certificate Number	Issuing Authority	Date of Issue	Date of Expiry
1.	Permanent Account Number (PAN)	AAFCE7937E	Income Tax Department, Government of India	January 17, 2020	Valid until cancelled
2.	Tax Deduction Account Number (TAN)	BLRE10524D	Income Tax Department, Government of India	January 17, 2020	Valid until cancelled
3.	Certificate of Registration issued under the provisions of Central Goods and Service Tax Act, 2017 for premise Plot Shed No. D2-12, Bicholim Industrial Estate, Bicholim, North Goa, Goa, 403504	30AAFCE7937E1ZU	Government of India	January 29, 2020	Valid until cancelled

Sr. No.	Description	Registration / Approval / Certificate Number	Issuing Authority	Date of Issue	Date of Expiry
4.	Registration under the Employees' Provident Fund and Miscellaneous Provisions Act, 1952	10000472179GOA	Employees' Provident Fund Organisation	September 21,2020	Valid until Cancelled
5.	Registration Certificate under Goa, Daman and Diu Shops and Establishment Rules, 1975 for premises at Plot No. 57, Shed No. D2-12, Industrial Estate, Bicholim, Goa, 403504.	S&E/II/BICH-Y2K/1446	Labour Inspector, Office of the Labour Inspector, Bicholim	January 17,2020	December 31,2022

#### IV. KEY BUSINESS RELATED APPROVALS

##### b. Approvals obtained by the Company

Sr. No.	Description	Registration / Approval / Certificate Number	Issuing Authority	Date of Issue	Date of Expiry
1.	Licensing Agreement dated July 21, 2017 for Transfer of Technology between Defence Research & Development Establishment, Gwalior under Defence Research & Development Organisation (DRDO), Ministry of Defence and OM Ventures for transfer of technology of "BioDigester". License bearing No. DRDO/DI <sup>2</sup> TM/2017/685 Government of India has authorized OM Ventures to use the transferred technology of Bio Digester (Bio Toilets) for commercial purposes. Subsequently, vide a letter dated October 25, 2021 bearing No. DRDO/DIITM/ToT/DRDE/2021 issued by the Joint Director, DIITM, it has approved transfer of licence from OM Ventures to the Company for Biodigester technology	DRDO/DIITM/ToT/DRDE/2021	Ministry of Defence and Research Development Organization(DRDO) and Dte of Industry and Interface & Technology Management(DIITM)	July 21, 2017	July 26, 2027

Sr. No.	Description	Registration / Approval / Certificate Number	Issuing Authority	Date of Issue	Date of Expiry
2.	ISO 9001:2015 Certificate for Manufacturing and supply of fibre reinforced polymer FRP products such as door shutters, frames, Biodigester tanks, bio toilets besides bacteria inoculums and allied products for construction and industrial applications	836/Q/210320	International Organization for Standardization	March 21, 2020	March 20, 2023
3.	Udyam Certificate	UDYAM-GA-01-0000907	Ministry of MSME	-	-
4.	Consent to Operate under Water (Prevention and Control of Pollution) Act, 1974, Air (Prevention and Control of Pollution) Act, 1981*	5/4127/08-PCB/10793	Goa State Pollution Control Board	April 03, 2013	May 15, 2023
5.	Import Exporter Code for Company's Plot no. 57 Shed no. D2/12, Bicholim Industrial Estate Bicholim North Goa- 403504	AAFCE7937E	Directorate General of Foreign trade, Ministry of Commerce and Industry	May 19, 2020	-

The Company has also obtained a Certificate of Registration under the Employee State Insurance Act, 1948 bearing no. 32000078520001099 from Asst./Dy. Director, Employees' State Insurance Corporation.

\* Consent to Operate was issued dated April 03, 2013 to OM ventures vide certificate number 5/4127/08-PCB/10793. Subsequently, vide an amendment letter dated November 09, 2021 bearing No. 5/4127/21/12822-PCB/Tech/14380 issued by the Assistant environmental Engineer, Goa Pollution control board, it has approved transfer of consent from OM Ventures to the Company.

## V. INTELLECTUAL PROPERTY

For details regarding Intellectual Property, please refer chapter titled "Our Business" beginning on page no. 72 of this Prospectus

## VI. PENDING APPROVAL

1. The Company has made an application to The Chief Inspector of Factories bearing application no. FAB2200466 for Factories license under Factories Act, 1948 for its premise situated at D2/12, Bicholim Industrial Estate Bicholim, North Goa- 403504.

## SECTION IX – OTHER REGULATORY AND STATUTORY DISCLOSURES

### Authority for the Issue

Our Board of Directors have vide resolution dated January 7, 2022 authorized the Issue, subject to the approval by the shareholders of our Company under Section 62 (1) (c) of the Companies Act, 2013.

The shareholders have authorized the Issue, by passing a Special Resolution at the Extra-Ordinary General Meeting held with shorter notice on January 10, 2022, in accordance with the provisions of Section 62(1)(c) of the Companies Act, 2013.

The Company has obtained approval from BSE vide letter dated March 10, 2022 to use the name of BSE in this Offer Document for listing of equity shares on the SME Platform of the BSE Limited. BSE Limited is the designated stock exchange.

### Prohibition by SEBI or Governmental Authorities

We confirm that there is no prohibition on our Company, its Directors, Promoters, Group Companies and entities forming part of our Promoter Group, person in control of our Company from accessing the capital market or operating in the capital markets or debarred from buying, selling or dealing in securities under any order or direction passed by the SEBI or any securities market regulator in any other jurisdiction or any other authority / court as on the date of this Prospectus.

The listing of any securities of our Company has never been refused at any time by any of the stock exchanges in India.

### Prohibition by RBI

Neither our Company nor any of our Promoters or Directors has been declared as Wilful Defaulter or a fraudulent borrower (s) by the RBI or any other governmental authority.

### Compliance with the Companies (Significant Beneficial Ownership) Rules, 2018

Our Company is in compliance with the Companies (Significant Beneficial Ownership) Rules, 2018 (“SBO Rules”), to the extent applicable, as on the date of this Prospectus.

### Association with Securities Market

None of our Directors are, in any manner, associated with the securities market and there has been no action initiated by SEBI against the Directors of our Company in the five years preceding the date of this Prospectus except as stated under the chapters titled “*Risk factors*”, “*Our Promoters, Promoter Group*”, “*Group Companies*” and “*Outstanding Litigations and Material Developments*” beginning on page nos. 19, 113, 117, 152 respectively, of this Prospectus.

### Eligibility for the Issue

Our Company is an “Unlisted Issuer” in terms of the SEBI (ICDR) Regulations; and this Issue is an “Initial Public Issue” in terms of the SEBI (ICDR) Regulations.

This Issue is being made in terms of Regulation 229(1) of Chapter IX of the SEBI (ICDR) Regulations, 2018, as amended from time to time, whereby, an issuer, whose post issue face value capital is less than ten crores rupees, shall issue shares to the public and propose to list the same on the Small and Medium Enterprise Exchange (in this case being the SME Platform of BSE Limited).

As per Regulation 229 (3) of the SEBI ICDR Regulations, our Company satisfies track record and/or other eligibility conditions of SME platform of the BSE Limited.

- a. Our Company was incorporated on January 17, 2020, with the Registrar of Companies, Goa under the Companies Act, 2013 in India. Further, Our Company has acquired the running business of M/s. OM Ventures (Proprietorship Firm of our Promoter, Mrs. Leena Kamat) with effect from August 31, 2021

- b. As on the date of this Prospectus, our Company has a total paid up capital of ₹ 117.75 lakhs comprising 11, 77,500 Equity Shares and the Post Issue Capital will be of ₹ 168.15 lakhs which is below ₹ 25 crores.
- c. The Proprietorship firm which has been taken over by our Company has track record of 3 years
- d. Our Company has Net Tangible Assets of ₹402.28 lakhs which is more than ₹ 150 Lakhs.
- e. Our Company has positive cash accruals (Earnings before depreciation and tax) from operations for at least 1 (one) financial years preceding the date of filing of this Prospectus and the net worth of our Company is positive as per the latest audited financial statements. As per Restated Financial Statements, the cash accruals accounted for March 31, 2022 was ₹ 123.20 lakhs.
- f. Our Company has not been referred to Board for Industrial and Financial Reconstruction (BIFR).
- g. There is no winding up petition against the company, which has been admitted by a Court of competent jurisdiction or a liquidator has not been appointed.
- h. There has been no change in the Promoter(s) of the Company in the preceding one year from date of filing application to BSE for listing on SME Platform of BSE.
- i. Our company has facilitated trading in demat securities and has entered into an agreement with both the depositories.
- j. No material regulatory or disciplinary action by a stock exchange or regulatory authority in the past three years against the applicant Company.
- k. Our Company has a website: [www.epbiocomposites.com](http://www.epbiocomposites.com)
- l. As per Restated Financial Statements, the Net-worth (excluding revaluation reserves) of the Company is ₹ 199.84 lakhs as at March 31, 2022.

As per Regulation 230 (1) of the SEBI ICDR Regulations, our Company has ensured that:

- The Prospectus has been filed with BSE and our Company has made an application to BSE for listing of its Equity Shares on the SME Platform of BSE Limited. BSE Limited is the Designated Stock Exchange.
- Our Company has entered into an agreement dated March 23, 2020 with NSDL and agreement dated September 14, 2020 with CDSL for dematerialisation of its Equity Shares already issued and proposed to be issued.
- The entire pre-Issue capital of our Company has shares fully paid-up Equity Shares and the Equity Shares proposed to be issued pursuant to this IPO will be fully paid-up.
- The entire Equity Shares held by the Promoters are in dematerialised form.
- The entire fund requirements are to be financed from the Net Fresh Issue Proceeds, and there is no requirement to make firm arrangements of finance under Regulation 230(1)(e) of the SEBI ICDR Regulations through verifiable means towards at least 75% of the stated means of finance, excluding the amounts to be raised through the Issue. For details, please refer the chapter “*Objects of the Issue*” on page no.56 of this Prospectus.

Our Company confirms that it will ensure compliance with the conditions specified in Regulation 230 (1) of the SEBI ICDR Regulations, to the extent applicable.

Further, our Company confirms that it is not ineligible to make the Issue in terms of Regulation 228 of the SEBI ICDR Regulations, to the extent applicable. The details of our compliance with Regulation 228 of the SEBI ICDR Regulations are as follows:

- (a) Neither our Company nor our Promoters, members of our Promoter Group or our Directors are debarred from accessing the capital markets by the SEBI.

- (b) None of our Promoters or Directors are promoters or directors of any other companies which are debarred from accessing the capital markets by the SEBI.
- (c) Neither our Company nor our Promoters or Directors is a Wilful Defaulter or a fraudulent borrower.
- (d) None of our Promoters or Directors is a fugitive economic offender.

We further confirm that we shall be complying with all other requirements as laid down for such Issue under Chapter IX of SEBI (ICDR) Regulations, as amended from time to time and subsequent circulars and guidelines issued by SEBI and the Stock Exchange.

Further, in accordance with Regulation 268 (1) of the SEBI (ICDR) Regulations, we shall ensure that the total number of proposed allottees in the Issue shall be greater than or equal to fifty (50), otherwise, the entire application money will be unblocked forthwith. If such money is not repaid within four (4) days from the date our Company becomes liable to repay it, then our Company and every officer in default shall, on and from expiry of four (4) days, be liable to repay such application money, with an interest at the rate as prescribed under the Companies Act 2013. Further, in accordance with Section 40 of the Companies Act, 2013, the Company and each officer in default may be punishable with fine and/or imprisonment in such a case.

#### **DISCLAIMER CLAUSE OF SEBI**

**IT IS TO BE DISTINCTLY UNDERSTOOD THAT SUBMISSION OF PROSPECTUS TO SECURITIES AND EXCHANGE BOARD OF INDIA (SEBI) SHOULD NOT IN ANY WAY BE DEEMED OR CONSTRUED THAT THE SAME HAS BEEN CLEARED OR APPROVED BY SEBI. SEBI DOES NOT TAKE ANY RESPONSIBILITY EITHER FOR THE FINANCIAL SOUNDNESS OF ANY SCHEME OR THE PROJECT FOR WHICH THE ISSUE IS PROPOSED TO BE MADE OR FOR THE CORRECTNESS OF THE STATEMENTS MADE OR OPINIONS EXPRESSED IN THE OFFER DOCUMENT. THE LEAD MERCHANT BANKER ARYAMAN FINANCIAL SERVICES LIMITED, HAVE CERTIFIED THAT THE DISCLOSURES MADE IN THE OFFER DOCUMENT ARE GENERALLY ADEQUATE AND ARE IN CONFORMITY WITH SEBI (ISSUE OF CAPITAL AND DISCLOSURE REQUIREMENTS) REGULATIONS, 2018 IN FORCE FOR THE TIME BEING. THIS REQUIREMENT IS TO FACILITATE INVESTORS TO TAKE AN INFORMED DECISION FOR MAKING AN INVESTMENT IN THE PROPOSED ISSUE.**

**IT SHOULD ALSO BE CLEARLY UNDERSTOOD THAT WHILE THE COMPANY ARE PRIMARILY RESPONSIBLE FOR THE CORRECTNESS, ADEQUACY AND DISCLOSURE OF ALL RELEVANT INFORMATION IN THE PROSPECTUS, THE LEAD MERCHANT BANKER ARE EXPECTED TO EXERCISE DUE DILIGENCE TO ENSURE THAT THE COMPANY DISCHARGES ITS RESPONSIBILITY ADEQUATELY IN THIS BEHALF AND TOWARDS THIS PURPOSE, THE LEAD MERCHANT BANKER, ARYAMAN FINANCIAL SERVICES LIMITED HAVE FURNISHED TO SEBI, A DUE DILIGENCE CERTIFICATE DATED AUGUST 23, 2022 IN THE FORMAT PRESCRIBED UNDER SCHEDULE V(A) OF THE SECURITIES AND EXCHANGE BOARD OF INDIA (ISSUE OF CAPITAL AND DISCLOSURE REQUIREMENTS) REGULATIONS, 2018.**

**THE FILING OF THE PROSPECTUS DOES NOT, HOWEVER, ABSOLVE OUR COMPANY FROM ANY LIABILITIES UNDER THE COMPANIES ACT, 2013 OR FROM THE REQUIREMENT OF OBTAINING SUCH STATUTORY AND OTHER CLEARANCES AS MAY BE REQUIRED FOR THE PURPOSE OF THE PROPOSED ISSUE. SEBI FURTHER RESERVES THE RIGHT TO TAKE UP AT ANY POINT OF TIME, WITH THE LEAD MANAGER ANY IRREGULARITIES OR LAPSES IN THE PROSPECTUS.**

#### **Note:**

All legal requirements pertaining to the Issue will be complied with at the time of registration of this Prospectus with the RoC in terms of section 26 and 30 of the Companies Act, 2013.

#### **Disclaimer from our Company, Directors and the Lead Manager**

Our Company, the Directors and the Lead Manager accept no responsibility for statements made otherwise than those contained in this Prospectus or, in case of the Company, in any advertisements or any other material issued by or at our Company's instance and anyone placing reliance on any other source of information would be doing so at his or her own risk.



### **Disclaimer in respect of Jurisdiction**

This Issue is being made in India to persons resident in India including Indian nationals resident in India (who are not minors, except through their legal guardian), Hindu Undivided Families (HUFs), companies, corporate bodies and societies registered under the applicable laws in India and authorized to invest in shares, Mutual Funds, Indian financial institutions, commercial banks, regional rural banks, co-operative banks (subject to RBI permission), Trusts registered under the Societies Registration Act, 1860, as amended from time to time, or any other trust law and who are authorised under their constitution to hold and invest in shares, permitted insurance companies and pension funds and to non-residents including NRIs and FIIs. This Prospectus does not, however, constitute an offer to sell or an invitation to subscribe to Equity Shares offered hereby in any other jurisdiction to any person to whom it is unlawful to make an offer or invitation in such jurisdiction. Any person into whose possession the Prospectus comes is required to inform himself or herself about, and to observe, any such restrictions. Any dispute arising out of this issue will be subject to the jurisdiction of appropriate court(s) in Mumbai only.

No action has been or will be taken to permit a public offering in any jurisdiction where action would be required for that purpose. Accordingly, the Equity Shares represented thereby may not be offered or sold, directly or indirectly, and the Prospectus may not be distributed, in any jurisdiction, except in accordance with the legal requirements applicable in such jurisdiction. Neither the delivery of the Prospectus nor any sale hereunder shall, under any circumstances, create any implication that there has been any change in the affairs of our Company since the date hereof or that the information contained herein is correct as of any time subsequent to this date.

### **Disclaimer Clause of the BSE**

"BSE Limited ("BSE") has vide its letter dated March 10, 2022 given permission to "EP Biocomposites Limited" to use its name in the Offer Document as the Stock Exchange on whose Small and Medium Enterprises Platform ("SME platform") the Company's securities are proposed to be listed. BSE has scrutinized this offer document for its limited internal purpose of deciding on the matter of granting the aforesaid permission to the Company. BSE does not in any manner:

- i. warrant, certify or endorse the correctness or completeness of any of the contents of this offer document; or
- ii. warrant that this Company's securities will be listed on completion of Initial Public Offering or will continue to be listed on BSE; or
- iii. take any responsibility for the financial or other soundness of this Company, its promoters, its management or any scheme or project of this Company.
- iv. warrant, certify or endorse the validity, correctness or reasonableness of the price at which the equity shares are offered by the Company and investors are informed to take the decision to invest in the equity shares of the Company only after making their own independent enquiries, investigation and analysis. The price at which the equity shares are offered by the Company is determined by the Company in consultation with the Merchant Banker (s) to the issue and the Exchange has no role to play in the same and it should not for any reason be deemed or construed that the contents of this offer document have been cleared or approved by BSE. Every person who desires to apply for or otherwise acquire any securities of this Company may do so pursuant to independent inquiry, investigation and analysis and shall not have any claim against BSE whatsoever by reason of any loss which may be suffered by such person consequent to or in connection with such subscription/acquisition whether by reason of anything stated or omitted to be stated herein or for any other reason whatsoever.
- v. BSE does not in any manner be liable for any direct, indirect, consequential or other losses or damages including loss of profits incurred by any investor or any third party that may arise from any reliance on this offer document or for the reliability, accuracy, completeness, truthfulness or timeliness thereof.
- vi. The Company has chosen the SME platform on its own initiative and at its own risk, and is responsible for complying with all local laws, rules, regulations, and other statutory or regulatory requirements stipulated by BSE/other regulatory authority. Any use of the SME platform and the related services are subject to Indian laws and Courts exclusively situated in Mumbai".

### **Disclaimer Clause under Rule 144A of the U.S. Securities Act**

The Equity Shares have not been and will not be registered under the U.S. Securities Act 1933, as amended (the "Securities Act") or any state securities laws in the United States and may not be offered or sold within the United States or to, or for the account or benefit of, "U.S. persons" (as defined in Regulation S of the Securities Act), except pursuant to an exemption from, or in a transaction not subject to, the registration requirements of the Securities Act. Accordingly, the Equity Shares will be offered and sold (i) in the United States only to "qualified institutional buyers", as defined in Rule 144A of the Securities Act, and (ii) outside the United States in offshore transactions in reliance on Regulation S

under the Securities Act and in compliance with the applicable laws of the jurisdiction where those offers and sales occur.

The Equity Shares have not been and will not be registered, listed or otherwise qualified in any other jurisdiction outside India and may not be offered or sold, and Applicants may not be made by persons in any such jurisdiction, except in compliance with the applicable laws of such jurisdiction.

### **Listing**

Application have been made to SME Platform of BSE Limited for obtaining permission for listing of the Equity Shares being offered and sold in the issue on its SME Platform of BSE Limited after the allotment in the Issue. BSE is the Designated Stock Exchange, with which the Basis of Allotment will be finalized for the Issue.

If the permission to deal in and for an official quotation of the Equity Shares on the SME Platform of BSE Limited is not granted by BSE, our Company shall forthwith repay, without interest, all moneys received from the applicants in pursuance of the prospectus. The allotment letters shall be issued or application money shall be refunded / unblocked within fifteen days from the closure of the Issue or such lesser time as may be specified by Securities and Exchange Board or else the application money shall be refunded to the applicants forthwith, failing which interest shall be due to be paid to the applicants at the rate of fifteen per cent per annum for the delayed period as prescribed under Companies Act, 2013, the SEBI (ICDR) Regulations and other applicable law.

Our Company shall ensure that all steps for the completion of the necessary formalities for listing and commencement of trading at the SME Platform of BSE Limited mentioned above are taken within 6 Working Days of the Issue Closing Date.

The Company has obtained approval from BSE vide letter dated March 10, 2022 to use the name of BSE in this Offer document for listing of equity shares on SME Platform of BSE Limited.

**Price Information of past issues handled by the Lead Manager**

Sr. No	Issue Name	Issue size (₹ in Cr.)	Issue Price (₹)	Listing date	Opening price on listing date	+/- % change in Price on closing price, [+/- % change in closing benchmark]- 30 <sup>th</sup> calendar days from listing		+/- % change in Price on closing price, [+/- % change in closing benchmark]- 90 <sup>th</sup> calendar days from listing		+/- % change in Price on closing price, [+/- % change in closing benchmark]- 180 <sup>th</sup> calendar days from listing	
1.	Modi's Navnirman Limited	22.68	180	06-07-22	189	75.00%	8.63%	NA	NA	NA	NA
2.	SP Refractories Limited	4.92	90	22-03-22	90.2	(11.11%)	0.45%	(8.89%)	(11.35%)	NA	NA
3.	Fabino Life Sciences Ltd.	3.24	36.00	13-01-22	38.45	(1.53%)	(5.03%)	(27.78%)	(4.73%)	(33.33%)	(12.00%)
4.	Suyog Gurbaxani Funicular Ropeways Ltd.	29.50	45.00	16-11-21	45.45	12.44%	(4.01%)	1.11%	(6.49%)	1.11%	(12.48%)
5.	CWD Ltd.	18.01	180.00	13-10-21	180.90	30.39%	(0.08%)	100.83%	(0.20%)	329.14%	(2.92%)
6.	Gretex Corporate Services Ltd.	5.13	170.00	09-08-21	172.00	9.38%	7.07%	19.29%	10.41%	17.65%	7.80%
7.	Times Green Energy (India) Ltd.	4.05	61.00	30-06-21	61.40	0.08%	0.20%	3.28%	13.69%	0.08%	9.41%
8.	Adeshwar Meditex Ltd.	9.75	25.00	28-06-21	25.25	0.20%	(0.55%)	14.00%	13.87%	44.20%	8.32%
9.	Pavna Industries Ltd.	29.70	165.00	09-03-21	165.60	0.06%	(1.49%)	1.21%	4.33%	9.09%	14.74%
10.	Net Pix Shorts Digital Media Ltd.	2.70	30.00	02-12-20	30.15	0.83%	7.29%	0.17%	12.73%	14.50%	8.80%

## Summary Statement of Disclosure

Financial Year	Total no. of IPOs	Total Funds Raised (Rs. In Cr.)	No. of IPOs trading at discount - 30th calendar day from listing day			Nos. of IPOs trading at premium - 30th calendar day from listing day			No. of IPOs trading at discount - 180th calendar day from listing day			Nos. of IPOs trading at premium - 180th calendar day from listing day		
			Over 50%	Between 25-50%	Less than 25%	Over 50%	Between 25-50%	Less than 25%	Over 50%	Between 25-50%	Less than 25%	Over 50%	Between 25-50%	Less than 25%
2022-23	1	22.68	0	0	0	1	0	0	0	0	0	0	0	0
2021-22	7	74.60	0	0	2	0	1	4	0	1	0	1	1	3
2020-21	4	46.47	0	1	0	0	0	3	1	0	0	1	0	2

### Notes:

(1) Since the listing date of Modi's Navnirman Limited was on July 06, 2022, information related to closing price and benchmark index as on the 90<sup>th</sup> and 180<sup>th</sup> Calendar day from the listing date is not available.

(2) Since the listing date of SP Refractories Limited was on March 22, 2022, information related to closing price and benchmark index as on the 180<sup>th</sup> Calendar day from the listing date is not available.

(3) The respective Designated Stock Exchange for each Issue has been considered as the Benchmark index for each of the above Issues.

(4) In the event any day falls on a holiday, the price/index of the immediate preceding working day has been considered. If the stock was not traded on the said calendar days from the date of listing, the share price is taken of the immediately preceding trading day.

(5) Source: [www.bseindia.com](http://www.bseindia.com) and [www.nseindia.com](http://www.nseindia.com) BSE Sensex and Nifty Fifty as the Benchmark Indices

### Track record of past issues handled by the Lead Manager

For details regarding the track record of the Lead Manager to the Offer as specified in Circular reference CIR/MIRSD/1/ 2012 dated January 10, 2012 issued by the SEBI, please see the website of Aryaman Financial Services Limited – [www.afsl.co.in](http://www.afsl.co.in)

### Consents

Consents in writing of: (a) The Directors, the Chief Financial Officer, Company Secretary & Compliance Officer and the Statutory Auditor; and (b) the Lead Manager, Registrar to the Issue, the Legal Advisor to the Issue, Banker to the Company, Banker to the Issue, Market Maker and Underwriters to act in their respective capacities, have been obtained and shall be filed along with a copy of this Prospectus with the RoC, as required under Section 26 of the Companies Act, 2013 and such consents shall not be withdrawn up to the time of delivery of this Prospectus for registration with the RoC.

In accordance with the Companies Act, 2013 and the SEBI (ICDR) Regulations, M/s. S.P. Bhandare & Associates., Chartered Accountants, have provided their written consent to the inclusion of their reports dated June 06, 2022 on Restated Financial Statements and to the inclusion of their reports date June 06, 2022 on Statement of Tax Benefits, which may be available to the Company and its shareholders, included in this Prospectus in the form and context in which they appear therein and such consents and reports have not been withdrawn up to the time of filing of this Prospectus.

## **Expert Opinion**

Except as stated below, our Company has not obtained any expert opinions:

Our Company has received written consent from the Statutory Auditor namely, M/s. . S.P. Bhandare & Associates., Chartered Accountants, to include their name as required under Section 26(1)(a)(v) of the Companies Act, 2013 in this Prospectus and as “Expert” as defined under section 2(38) of the Companies Act, 2013 in respect of the reports on the Statement of Tax Benefits dated June 06, 2022 and on the Restated Financial Statements dated June 06, 2022 and issued by them, included in this Prospectus and such consent has not been withdrawn as on the date of this Prospectus.

However, the term “expert” shall not be construed to mean an “expert” as defined under the U.S. Securities Act.

## **Caution**

The Lead Manager accepts no responsibility, save to the limited extent as provided in the MoU for Issue Management entered into among the Lead Manager and our Company dated January 21, 2022 and addendum dated June 02, 2022, the Underwriting Agreement dated March 09,2022 and addendum dated June 02, 2022, entered into among the Underwriter, and our Company and the Market Making Agreement dated March 09,2022 and addendum dated June 02, 2022, entered into among the Market Maker, Lead Manager and our Company. All information shall be made available by us and the Lead Manager to the public and investors at large and no selective or additional information would be available for a section of the investors in any manner whatsoever including at road show presentations, in research or sales reports or at collection centres or elsewhere.

## **CAPITAL ISSUE DURING THE LAST FIVE YEARS**

### **Previous Public and Rights Issues**

We have not made any rights to the public and public issues in the past, and we are an “Unlisted Company” in terms of the SEBI (ICDR) Regulations and this Issue is an “Initial Public Offering” in terms of the SEBI (ICDR) Regulations.

### **Commission and Brokerage Paid on Previous Issues of our Equity Shares**

Since this is an Initial Public Offer of the Company, no sum has been paid or has been payable as commission or brokerage for subscribing to or procuring or agreeing to procure subscription for any of the Equity Shares since inception of the Company.

### **Capital Issues in the last three (3) years by Listed Group Companies / Subsidiaries / Associates**

None of our Group Companies / Associates that are listed on any Stock Exchange has made any Capital Issue in the last three (3) years.

We do not have any subsidiary as on date of this Prospectus.

### **Previous Issues of Equity Shares otherwise than for Cash**

Except as stated in the chapter titled “*Capital Structure*” beginning on page no. 48 of this Prospectus, we have not issued any Equity Shares for consideration other than for cash.

## **Performance vis-à-Vis Objects**

### **Issuer Company**

Our Company has not made any public issue (including any rights issue to the public) since its incorporation.

### **Listed Subsidiaries / Promoters**

We do not have any listed Subsidiary or Promoter Company as on date of this Prospectus.

## Stock Market Data of Equity Shares

This being initial public offer of the Equity Shares of our Company, the Equity Shares are not listed on any stock exchange and accordingly, no stock market data is available for the Equity Shares.

## Outstanding Debentures, Bonds, Redeemable Preference Shares and Other Instruments issued by the Company

The Company has no outstanding debentures or bonds. The Company has not issued any redeemable preference shares or other instruments in the past.

## Disposal of Investor Grievances

### Mechanism for Redressal of Investor Grievances

The Company has appointed Bigshare Services Private Limited as the Registrar to the Issue, to handle the investor grievances in co-ordination with the Compliance Officer of the Company. All grievances relating to the present Issue may be addressed to the Registrar with a copy to the Compliance Officer, giving full details such as name, address of the applicant, number of Equity Shares applied for, amount paid on application and name of bank and branch. The Company would monitor the work of the Registrar to ensure that the investor grievances are settled expeditiously and satisfactorily.

The Registrar to the Issue will handle investor's grievances pertaining to the Issue. A fortnightly status report of the complaints received and redressed by them would be forwarded to the Company. The Company would also be co-ordinating with the Registrar to the Issue in attending to the grievances to the investor.

All grievances relating to the ASBA process may be addressed to the SCSBs, giving full details such as name, address of the applicant, number of Equity Shares applied for, amount paid on application and the Designated Branch of the SCSB where the Application Form was submitted by the ASBA Applicant. We estimate that the average time required by us or the Registrar to the Issue or the SCSBs for the redressal of routine investor grievances will be seven business days from the date of receipt of the complaint. In case of non-routine complaints and complaints where external agencies are involved, we will seek to redress these complaints as expeditiously as possible.

The Company shall obtain authentication on the SCORES and comply with the SEBI circular (CIR/OIAE/1/2013) dated April 17, 2013 in relation to redressal of investor grievances through SCORES.

Our Board by a resolution on April 28, 2020 constituted a Stakeholders Relationship Committee. The composition of the Stakeholders Relationship Committee is as follows:

Name of the Directors	Nature of Directorship	Designation in Committee
Leena Kamat	Non-Executive Director	Chairman
Dinesh Shenoy	Non- Executive Independent Director	Member
Rajkumar Kamat	Managing Director	Member

For further details, please see the chapter titled "*Our Management*" beginning on page no.101 of this Prospectus.

Our Company has also appointed Mohammad Faiyazul Haq, as the Compliance Officer for the Issue and he may be contacted at the Registered Office of our Company.

### Mohammad Faiyazul Haq

#### Address:

C/O OM Ventures, Shed No D-2/12, Bicholim Industrial Estate,  
Bicholim, Goa – 403504.

**Tel. No:** +91-832-2431081/91-9158005202

**Email:** info@epkamatgroup.com

Investors can contact the Compliance Officer or the Registrar to the Issue or the Lead Manager in case of any pre Issue or post Issue related problems, such as non-receipt of letters of Allotment, credit of Allotted Equity Shares in the respective beneficiary accounts and refund orders.

**Status of Investor Complaints**

We confirm that we have not received any investor complaint during the three years preceding the date of this Prospectus and hence there are no pending investor complaints as on the date of this Prospectus.

**Disposal of Investor Grievances by Listed Companies under the same Management**

None of our Group Companies / Associates / Subsidiaries is listed on any Stock Exchange as on the date of filing this Prospectus.

**Exemption From Complying With Any Provisions Of Securities Laws, If Any, Granted By SEBI**

Our company has not applied or received any exemption from complying with any provisions of securities laws by SEBI.

## SECTION X – ISSUE INFORMATION

### TERMS OF THE ISSUE

*The Equity Shares being Allotted pursuant to this Issue shall be subject to the provisions of the Companies Act, SEBI ICDR Regulations, SEBI Listing Regulations, SCRA, SCRR, our Memorandum of Association and Articles of Association, the terms of the Prospectus, the Prospectus, the Abridged Prospectus, Application Form, any Revision Form, the CAN/Allotment Advice and other terms and conditions as may be incorporated in the Allotment Advice and other documents/certificates that may be executed in respect of the Issue. The Equity Shares shall also be subject to laws as applicable, guidelines, rules, notifications and regulations relating to the issue of capital and listing and trading of securities issued from time to time by SEBI, the Government of India, the Stock Exchange(s), the RBI, RoC and/or other authorities, as in force on the date of the Issue and to the extent applicable or such other conditions as may be prescribed by the SEBI, the RBI, the Government of India, the Stock Exchange(s), the RoC and/or any other authorities while granting its approval for the Issue.*

*Please note that, in terms of Regulation 256 of the SEBI ICDR Regulations 2018 read with SEBI Circular No. CIR/CFD/POLICYCELL/11/2015 dated November 10, 2015, all the applicants have to compulsorily apply through the ASBA Process and further in terms of SEBI through its circular no. SEBI/HO/CFD/DIL2/CIR/P/2018/138 dated November 1, 2018, and as modified through its circular SEBI/HO/CFD/DIL2/CIR/P/2019/50 dated April 3, 2019, circular no. SEBI/HO/CFD/DIL2/CIR/P/2019/76 dated June 28, 2019, circular no. SEBI/HO/CFD/DIL2/CIR/P/2019/85 dated July 26, 2019 and circular no. SEBI/HO/CFD/DCR2/CIR/P/2019/133 dated November 8, 2019 and the circular no. SEBI/HO/CFD/DIL2/CIR/P/2020/50 dated March 30, 2020 (together, the “UPI Circulars”) in relation to clarifications on streamlining the process of public issue of equity shares and convertibles it has proposed to introduce an alternate payment mechanism using Unified Payments Interface (“UPI”) and consequent reduction in timelines for listing in a phased manner. Currently, for application by RIIs through Designated Intermediaries, the existing process of physical movement of forms from Designated Intermediaries to SCSBs for blocking of funds is discontinued and RIIs submitting their Application Forms through Designated Intermediaries (other than SCSBs) can only use the UPI mechanism with existing timeline of T+6 days until March 31, 2020 (“UPI Phase II”). Further SEBI through its circular no SEBI/HO/CFD/DIL2/CIR/P/2020/50 dated March 30, 2020 has decided to continue with the Phase II of the UPI ASBA till further notice. Further vide the said circular Registrar to the Issue and Depository Participants have been also authorized to collect the Application forms. Investor may visit the official website of the concerned for any information on operationalization of this facility of form collection by the Registrar to the Issue and Depository Participants as and when the same is made available.*

#### **The Issue**

The Issue comprises of a Fresh Issue

The listing fees shall be borne by our Company. Other Issue-related expenses shall be borne by our Company. For details in relation to Issue expenses, see “*Objects of the Issue*” beginning on page 55.

#### **Ranking of Equity Shares**

The Equity Shares being issued and transferred shall be subject to the provisions of the Companies Act, our Memorandum and Articles of Association, SEBI ICDR Regulations, SCRA and shall rank *pari-passu* in all respects including dividend with the existing Equity Shares including in respect of the rights to receive dividends and other corporate benefits, if any, declared by us after the date of Allotment. For further details, please see the section titled “*Main Provisions of the Articles of Association*” are beginning from page no. 199 of this Prospectus.

#### **Mode of Payment of Dividend**

Our Company shall pay dividends, if declared, to the Shareholders in accordance with the provisions of the Companies Act, the Memorandum and Articles of Association and provisions of the SEBI Listing Regulations and any other guidelines or directions which may be issued by the Government in this regard. Dividends, if any, declared by our Company after the date of Allotment will be payable to the Applicants who have been Allotted Equity Shares in the Issue, for the entire year, in accordance with applicable laws. For further details, in relation to dividends, see “*Dividend Policy*” and “*Main Provisions of the Articles of Association*” beginning on page nos. 120 and 199 of this Prospectus.



## Face Value and Issue Price

The Equity Shares having a face value of ₹ 10 each are being issued in terms of this Prospectus at the price of 126 per Equity Share. The Issue Price is determined by our Company in consultation with the Lead Manager and is justified under the chapter titled "*Basis for Issue Price*" beginning on page no. 61 of this Prospectus.

At any given point of time there shall be only one denomination of the Equity Shares of our Company, subject to applicable laws.

## Compliance with SEBI (ICDR) Regulations, 2018

Our Company shall comply with all requirements of the SEBI (ICDR) Regulations, 2018. Our Company shall comply with all disclosure and accounting norms as specified by SEBI from time to time.

## Rights of the Equity Shareholders

Subject to applicable laws, rules, regulations and guidelines and our Articles of Association, our Shareholders shall have the following rights:

- Right to receive dividends, if declared;
- Right to attend general meetings and exercise voting rights, unless prohibited by law;
- Right to vote on a poll either in person or by proxy and e-voting, in accordance with the provisions of the Companies Act;
- Right to receive offers for rights shares and be allotted bonus shares, if announced;
- Right to receive surplus on liquidation, subject to any statutory and preferential claim being satisfied;
- Right of free transferability of the Equity Shares, subject to applicable laws including any RBI rules and regulations; and
- Such other rights, as may be available to a shareholder of a listed public company under the Companies Act, the SEBI Listing Regulations, and our Memorandum of Association and Articles of Association.

For a detailed description of the main provisions of the Articles of Association of our Company relating to voting rights, dividend, forfeiture and lien, transfer, transmission and/or consolidation or splitting, see "*Main Provisions of Articles of Association*" beginning on page no. 199 of this Prospectus.

## Allotment only in Dematerialised Form

Pursuant to Section 29 of the Companies Act, 2013 and the SEBI ICDR Regulations, the Equity Shares shall be allotted only in dematerialised form. As per the SEBI ICDR Regulations, the trading of the Equity Shares shall only be in dematerialized form. In this context, two agreements have been signed amongst our Company, the respective Depositories and the Registrar to the Issue:

- 1) Tripartite agreement dated March 23, 2020 between our Company, NSDL and the Registrar and Share Transfer Agent to the Issue.
- 2) Tripartite agreement dated September 14, 2020 between our Company, CDSL and the Registrar and Share Transfer Agent to the Issue.

The Company's shares bear ISIN INE0D2I01014.

## Market Lot and Trading Lot

Trading of the Equity Shares will happen in the minimum contract size of 1,000 Equity Shares in terms of the SEBI circular no. CIR/MRD/DSA/06/2012 dated February 21, 2012 and the same may be modified by BSE from time to time by giving prior notice to investors at large. Allocation and allotment of Equity Shares through this Issue will be done in multiples of 1,000 Equity Share subject to a minimum allotment of 1,000 Equity Shares to the successful Applicants. Further, in accordance with SEBI (ICDR) Regulations the minimum application size in terms of number of specified securities shall not be less than Rupees One Lakh per application.

### **Minimum Number of Allottees**

In accordance with Regulation 268 (1) of SEBI (ICDR) Regulations, the minimum number of allottees in this Issue shall be 50 shareholders. In case the minimum number of prospective allottees is less than 50, no allotment will be made pursuant to this Issue and the monies collected shall be refunded within eight (8) Working days of closure of Issue.

### **Joint Holders**

Where two or more persons are registered as the holders of the Equity Shares, they will be deemed to hold such Equity Shares as joint tenants with benefits of survivorship.

### **Nomination facility to investors**

In accordance with Section 72 (1) & 72 (2) of the Companies Act, 2013, the sole or first applicant, along with other joint applicant, may nominate any one person in whom, in the event of the death of sole applicant or in case of joint applicant, death of all the applicants, as the case may be, the Equity Shares allotted, if any, shall vest. A person, being a nominee, entitled to the Equity Shares by reason of the death of the original holder(s), shall in accordance with Section 72 (3) of the Companies Act, 2013, be entitled to the same advantages to which he or she would be entitled if he or she were the registered holder of the Equity Share(s). Where the nominee is a minor, the holder(s) may make a nomination to appoint, in accordance to Section 72 (4) of the Companies Act, 2013, any person to become entitled to Equity Share(s) in the event of his or her death during the minority. A nomination shall stand rescinded upon a sale of equity share(s) by the person nominating. A buyer will be entitled to make a fresh nomination in the manner prescribed. Fresh nomination can be made only on the prescribed form available on request at the Registered Office of our Company or to the Registrar and Transfer Agents of our Company.

In accordance with Articles of Association of the Company, any Person who becomes a nominee by virtue of Section 72 of the Companies Act, 2013, shall upon the production of such evidence as may be required by the Board, elect either:

- ✓ to register himself or herself as the holder of the Equity Shares; or
- ✓ to make such transfer of the Equity Shares, as the deceased holder could have made

Further, the Board may at any time give notice requiring any nominee to choose either to be registered himself or herself or to transfer the Equity Shares, and if the notice is not complied with within a period of ninety days, the Board may thereafter withhold payment of all dividends, bonuses or other moneys payable in respect of the Equity Shares, until the requirements of the notice have been complied with.

Since the Allotment of Equity Shares in the Issue will be made only in dematerialized mode there is no need to make a separate nomination with our Company. Nominations registered with respective Depository Participant of the Applicant would prevail. If the Applicant wants to change the nomination, they are requested to inform their respective Depository Participant.

### **Withdrawal of the Issue**

Our Company in consultation with the Lead Manager, reserve the right not to proceed with the Fresh Issue in whole or in part thereof, to the extent of Issued Shares, at any time after the Issue Opening Date but before the Board meeting for Allotment. In such an event our Company would issue a public notice in the newspapers, in which the pre-Issue advertisements were published, within two days of the Issue Closing Date or such other time as may be prescribed by SEBI, providing reasons for not proceeding with the Issue. The Lead Manager, through the Registrar to the Issue, shall notify the SCSBs and Sponsor Bank (in case of RII's using the UPI Mechanism), to unblock the bank accounts of the ASBA Applicants and the Escrow Collection Bank to release the Application Amounts to the Anchor Investors, if applicable, within one day of receipt of such notification. Our Company shall also promptly inform the Stock Exchange on which the Equity Shares were proposed to be listed.

Notwithstanding the foregoing, this Issue is also subject to obtaining (i) the final listing and trading approvals of the Stock Exchanges, which our Company shall apply for after Allotment; and (ii) the final RoC approval of the Prospectus after it is filed with the RoC. If our Company in consultation with the Lead Manager withdraw the Issue after the Application/ Issue Closing Date and thereafter determine that they will proceed with public Issue of the Equity Shares, our Company shall file a fresh Prospectus with the Stock Exchanges.

## ISSUE PROGRAMME

An indicative timetable in respect of the Issue is set out below:

Event	Indicative Date
Issue Opening Date	August 29, 2022
Issue Closing Date	September 05, 2022
Finalisation of Basis of Allotment with the Designated Stock Exchange	September 08, 2022
Initiation of Allotment / Refunds / Unblocking of Funds <sup>(1)</sup>	September 09, 2022
Credit of Equity Shares to demat accounts of Allottees	September 12, 2022
Commencement of trading of the Equity Shares on the Stock Exchange	September 13, 2022

<sup>(1)</sup>In case of any delay in unblocking of amounts in the ASBA Accounts (including amounts blocked through the UPI Mechanism) exceeding four Working Days from the Issue Closing Date, the Applicants shall be compensated at a uniform rate of ₹ 100 per day for the entire duration of delay exceeding four Working Days from the Issue Closing Date by the intermediary responsible for causing such delay in unblocking. The Manager shall, in their sole discretion, identify and fix the liability on such intermediary or entity responsible for such delay in unblocking. For the avoidance of doubt, the provisions of the SEBI circular no. SEBI/HO/CFD/DIL2/CIR/P/2021/2480/1/M dated March 16, 2021, as amended pursuant to SEBI circular no. SEBI/HO/CFD/DIL2/P/CIR/2021/570 dated June 2, 2021 shall be deemed to be incorporated in the deemed agreement of the Company with the SCSBs to the extent applicable.

The above timetable is indicative and does not constitute any obligation on our Company or the Lead Manager. Whilst our Company shall ensure that all steps for the completion of the necessary formalities for the listing and the commencement of trading of the Equity Shares on the Stock Exchange are taken within 6 Working Days of the Issue Closing Date, the timetable may change due to various factors, such as extension of the Issue Period by our Company, or any delays in receiving the final listing and trading approval from the Stock Exchange. The Commencement of trading of the Equity Shares will be entirely at the discretion of the Stock Exchange and in accordance with the applicable laws.

Applications and any revision to the same shall be accepted **only between 10.00 a.m. and 5.00 p.m.** (IST) during the Issue Period (except for the Issue Closing Date). On the Issue Closing Date, the Applications and any revision to the same shall be accepted between **10.00 a.m. and 3.00 p.m.** (IST) or such extended time as permitted by the Stock Exchanges, in case of Applications by Retail Individual Applicants after taking into account the total number of applications received up to the closure of timings and reported by the Lead Manager to the Stock Exchanges. It is clarified that Applications not uploaded on the electronic system would be rejected. Applications will be accepted only on Working Days, i.e., Monday to Friday (excluding any public holiday).

Due to limitation of time available for uploading the Applications on the Issue Closing Date, the Applicants are advised to submit their Applications one day prior to the Issue Closing Date and, in any case, no later than 3.00 p.m. (IST) on the Issue Closing Date. All times mentioned in this Prospectus are Indian Standard Times. Applicants are cautioned that in the event a large number of Applications are received on the Issue Closing Date, as is typically experienced in public Issues, some Applications may not get uploaded due to lack of sufficient time. Such Applications that cannot be uploaded will not be considered for allocation under the Issue. Applications will be accepted only on Business Days. Neither our Company nor the Lead Manager is liable for any failure in uploading the Applications due to faults in any software/hardware system or otherwise.

In accordance with the SEBI ICDR Regulations, QIBs and Non-Institutional Applicants are not allowed to withdraw or lower the size of their applications (in terms of the quantity of the Equity Shares or the Applications Amount) at any stage. Retail Individual Applicants can revise or withdraw their Applications prior to the Issue Closing Date. Except Allocation to Retail Individual Investors, Allocation in the Issue will be on a proportionate basis.

In case of discrepancy in the data entered in the electronic book vis-à-vis the data contained in the physical or the electronic Application Form, for a particular Applicant, the details as per the file received from the Stock Exchange may be taken as the final data for the purpose of Allotment. In case of discrepancy in the data entered in the electronic book vis-à-vis the data contained in the physical or electronic Application Form, for a particular ASBA Applicant, the Registrar to the Issue shall ask the relevant SCSB or the member of the Syndicate for rectified data.

## **Minimum Subscription**

In accordance with Regulation 260(1) of SEBI (ICDR) Regulations, this Issue is 100% underwritten, so this issue is not restricted to any minimum subscription level.

As per section 39 of the new Companies Act, if the “stated minimum amount” has not been subscribed and the sum payable on application is not received within a period of thirty (30) days from the date of issue of prospectus, the application money has to be returned within such period as may be prescribed. If our Company does not receive the subscription of 100% of the Issue through this Issue Document including devolvement of Underwriters, our Company shall forthwith unblock / refund the entire subscription amount received in accordance with applicable law including the SEBI circular bearing no. SEBI/HO/CFD/DIL1/CIR/P/2021/47 dated March 31, 2021. If there is a delay beyond four (4) days after our Company becomes liable to pay the amount, our Company and our Directors, who are officers in default, shall pay interest at the rate of 15% per annum.

The minimum number of allottees in this Issue shall be 50 shareholders. In case the minimum number of prospective allottees is less than fifty (50), no allotment will be made pursuant to this Issue and the monies blocked by the SCSBs shall be unblocked within four (4) working days of closure of issue. In accordance with Regulation 260 (1) of the SEBI ICDR Regulations, our Issue shall be hundred percent underwritten. Thus, the underwriting obligations shall be for the entire hundred percent of the Issue through this Prospectus and shall not be restricted to the minimum subscription level. Further, in accordance with Regulation 267 (2) of the SEBI ICDR Regulations, our Company shall ensure that the minimum application size shall not be less than ₹ 1,00,000 (Rupees One Lakh) per application.

The Equity Shares have not been and will not registered, listed or otherwise qualified in any other jurisdiction outside India and may not be issued or sold, and applications may not be made by persons in any such jurisdiction, except in compliance with the application law of such jurisdiction.

## **Arrangements for Disposal of Odd Lots**

The trading of the Equity Shares will happen in the minimum contract size of 1,000 shares. However, the Market Maker shall buy the entire shareholding of a shareholder in one lot, where value of such shareholding is less than the minimum contract size allowed for trading on the SME platform of BSE.

## **Application by Eligible NRIs, FPIs or VCFs registered with SEBI**

It is to be understood that there is no reservation for Eligible NRIs, FPIs or VCF registered with SEBI. Such Eligible NRIs, FPIs or VCF registered with SEBI will be treated on the same basis with other categories for the purpose of Allocation.

## **As per the extent Guidelines of the Government of India, OCBs cannot participate in this Issue.**

The current provisions of the Foreign Exchange Management (Transfer or Issue of Security by a Person Resident outside India) Regulations, 2000, provides a general permission for the NRIs, FPIs and foreign venture capital investors registered with SEBI to invest in shares of Indian companies by way of subscription in an IPO. However, such investments would be subject to other investment restrictions under the Foreign Exchange Management (Transfer or Issue of Security by a Person Resident outside India) Regulations, 2000, RBI and/or SEBI regulations as may be applicable to such investors. The Allotment of the Equity Shares to Non-Residents shall be subject to the conditions, if any, as may be prescribed by the Government of India/RBI while granting such approvals.

## **Restrictions, if any on Transfer and Transmission of Equity Shares**

The lock-in of the pre- Issue capital of our Company as provided in “*Capital Structure*” beginning on page no. 48 of this Prospectus and except as provided in our Articles of Association there are no restrictions on transfer of Equity Shares. Further, there are no restrictions on the transmission of shares/debentures and on their consolidation/splitting, except as provided in the Articles of Association. For details, see “*Main Provisions of the Articles of Association*” beginning on page no. 199 of this Prospectus.

*The above information is given for the benefit of the Applicants. The Applicants are advised to make their own enquiries about the limits applicable to them. Our Company and the Lead Manager do not accept any responsibility for the completeness and accuracy of the information stated hereinabove. Our Company and the Lead Manager are not liable to inform to inform the investors of any amendments or modifications or changes in applicable laws or*

*regulations, which may occur after the date of this Prospectus. Applicants are advised to make their independent investigations and ensure that the number of Equity Shares Applied for do not exceed the applicable limits under laws or regulations.*

### **New Financial Instruments**

As on the date of this Prospectus, there are no outstanding warrants, new financial instruments or any rights, which would entitle the shareholders of our Company, including our Promoter, to acquire or receive any Equity Shares after the Issue.

### **Migration to Main Board**

In accordance with the BSE Circular dated March 10, 2014, our Company will have to be mandatorily listed and traded on the SME Platform of BSE for a minimum period of two years from the date of listing and only after that it can migrate to the Main Board of the BSE as per the guidelines specified by SEBI and as per the procedures laid down under Chapter IX of the SEBI (ICDR) Regulations.

As per the provisions of the Chapter IX of the SEBI ICDR Regulation, our Company may migrate to the main board of BSE from the SME Platform of BSE on a later date subject to the following:

- If the Paid up Capital of the Company is likely to increase above ₹ 25 crores by virtue of any further issue of capital by way of rights, preferential issue, bonus issue etc. (which has been approved by a special resolution through postal ballot wherein the votes cast by the shareholders other than the promoter in favour of the proposal amount to at least two times the number of votes cast by shareholders other than promoter shareholders against the proposal and for which the Company has obtained in-principal approval from the main board), we shall have to apply to BSE for listing our shares on its Main Board subject to the fulfilment of the eligibility criteria for listing of specified securities laid down by the Main Board.
- If the Paid up Capital of the Company is more than ₹ 10 crores but below ₹ 25 crores, we may still apply for migration to the main board if the same has been approved by a special resolution through postal ballot wherein the votes cast by the shareholders other than the promoter in favour of the proposal amount to at least two times the number of votes cast by shareholders other than promoter shareholders against the proposal.

### **Market Making**

The shares issued through this Issue are proposed to be listed on the SME Platform of BSE with compulsory market making through the registered Market Maker of the SME Exchange for a minimum period of three years or such other time as may be prescribed by the Stock Exchange, from the date of listing on SME Platform of BSE. For further details of the market making arrangement please refer the chapter titled “*General Information*” beginning on page no. 39 of this Prospectus.

## ISSUE STRUCTURE

This issue is being made in terms of Regulation 229 (1) of the Chapter IX of SEBI (ICDR) Regulations, 2018, as amended from time to time, whereby, our post issue face value capital is less than or equal to Ten Crores Rupees. The Company shall issue specified securities to the public and propose to list the same on the Small and Medium Enterprise Exchange ("SME Exchange", in this case being the SME Platform of BSE). For further details regarding the salient features and terms of such this Issue, please see the chapters titled "*Terms of the Issue*" and "*Issue Procedure*" beginning on page nos. 170 and 179 respectively, of this Prospectus.

### Issue Structure

Initial Public Issue of 5,04,000 Equity Shares of ₹ 10 each (*the "Equity Shares"*) for cash at a price of ₹ 126 per Equity Share (including a Share Premium of ₹ 116 per Equity Share), aggregating to ₹635.04 Lakhs (*the Issue*) by the EP Biocomposites Limited (*"EPBL" or the "Company"*).

The Issue comprises a reservation of 28,000 Equity Shares of ₹ 10 each for subscription by the designated Market Maker (*"the Market Maker Reservation Portion"*) and Net Issue to Public of 4,76,000 Equity Shares of ₹ 10 each (*"the Net Issue"*). The Issue and the Net Issue will constitute 29.87% and 28.30%, respectively of the post Issue paid up equity share capital of the Company. The Issue is being made through the Fixed Price Process.

Particulars	Net Issue to Public	Market Maker Reservation Portion
Number of Equity Shares available for allocation <sup>(1)</sup>	4,76,000 Equity Shares	28,000 Equity Shares
Percentage of Issue Size available for Allocation	94.44% of the Issue Size	5.56% of the Issue Size
Basis of Allotment	Proportionate subject to minimum allotment of 1,000 Equity Shares and further allotment in multiples of 1,000 Equity Shares each. <sup>(1)</sup>  For further details please refer section explaining the Basis of Allotment in the GID.	Firm Allotment
Mode of Application	All the applicants shall make the application (Online or Physical) through the ASBA Process only (including UPI mechanism for Retail Investors using Syndicate ASBA).	
Mode of Allotment	Compulsorily in dematerialised form.	
Minimum Application Size	<i>For Other than Retail Individual Investors:</i>  Such number of Equity Shares in multiples of 1,000 Equity Shares such that the Application Value exceeds ₹ 2,00,000.  <i>For Retail Individuals Investors:</i>  1,000 Equity Shares	28,000 Equity Shares
Maximum Application Size	<i>For Other than Retail Individual Investors:</i>  Such number of Equity Shares in multiples of 1,000 Equity Shares such that the Application Size does not exceed 4,76,000 Equity Shares, subject to applicable limits to the Applicant.  <i>For Retail Individuals Investors:</i>  Such number of Equity Shares in multiples of 1,000 Equity Shares such that the application value does not exceed ₹ 2,00,000.	28,000 Equity Shares
Trading Lot	1,000 Equity Shares	1,000 Equity Shares. However the Market Maker may buy odd lots if any in the market as required under

Particulars	Net Issue to Public	Market Maker Reservation Portion
		the SEBI (ICDR) Regulations, 2018.
Who can Apply <sup>(2)</sup>	<p><i>For Other than Retail Individual Investors:</i></p> <p>Resident Indian individuals, Eligible NRIs, HUFs (in the name of the Karta), companies, corporate bodies, scientific institutions societies and trusts.</p> <p><i>For Retail Individuals Investors:</i></p> <p>Resident Indian individuals, HUFs (in the name of the Karta) and Eligible NRIs.</p>	Market Maker
Terms of Payment <sup>(3)</sup>	The entire Application Amount will be payable at the time of submission of the Application Form.	
Application Lot Size	1,000 Equity Share and in multiples of 1,000 Equity Shares thereafter	

<sup>(1)</sup> Since present issue is a fixed price issue, the allocation in the net issue to the public category in terms of Regulation 253(2) of the SEBI (ICDR) Regulations, 2018 shall be made as follows:

- i. Minimum fifty per cent to retail individual investors; and
- ii. Remaining to:
  - (a) individual applicants other than retail individual investors; and
  - (b) other investors including corporate bodies or institutions, irrespective of the number of specified securities applied for;

Provided that the unsubscribed portion in either of the categories specified in (a) or (b) above may be allocated to the applicants in the other category.

<sup>2)</sup> In case of joint Applications, the Application Form should contain only the name of the first Applicant whose name should also appear as the first holder of the beneficiary account held in joint names. The signature of only such first Applicant would be required in the Application Form and such first Applicant would be deemed to have signed on behalf of the joint holders.

<sup>(3)</sup> In case of ASBA Applicants, the SCSB shall be authorised to block such funds in the bank account of the ASBA Applicant (including retail applicants applying through UPI mechanism) that are specified in the Application Form. SCSBs applying in the Issue must apply through an ASBA Account maintained with any other SCSB.

## ISSUE PROGRAMME

<b>ISSUE OPENING DATE</b>	August 29, 2022
<b>ISSUE CLOSING DATE</b>	September 05, 2022

Applications and any revisions to the same will be accepted only between 10.00 a.m. to 5.00 p.m. (Indian Standard Time) during the Issue Period at the Application Centres mentioned in the Application Form. On the Issue Closing Date applications will be accepted only between 10.00 a.m. to 4.00 p.m. (Indian Standard Time).

Due to limitation of time available for uploading the application on the Issue Closing Date, Applicants are advised to submit their applications one day prior to the Issue Closing Date and, in any case, not later than 1.00 p.m. IST on the Issue Closing Date. Any time mentioned in this Prospectus is IST. Applicants are cautioned that, in the event a large number of applications are received on the Issue Closing Date, as is typically experienced in public Issues, some applications may not get uploaded due to lack of sufficient time. Such applications that cannot be uploaded will not be considered for allocation under this Issue.

Applications will be accepted only on Working Days, i.e., Monday to Friday (excluding any public holiday)

## Lot Size

SEBI vide circular CIR/MRD/DSA/06/2012 dated February 21, 2012 (the “Circular”) standardized the lot size for Initial Public Issue proposing to list on SME exchange/platform and for the secondary market trading on such exchange/platform, as under:

Issue Price (in ₹)	Lot Size (No. of shares)
Up to 14	10,000
More than 14 up to 18	8,000
More than 18 up to 25	6,000
More than 25 up to 35	4,000
More than 35 up to 50	3,000
More than 50 up to 70	2,000
More than 70 up to 90	1,600
More than 90 up to 120	1,200
More than 120 up to 150	1,000
More than 150 up to 180	800
More than 180 up to 250	600
More than 250 up to 350	400
More than 350 up to 500	300
More than 500 up to 600	240
More than 600 up to 750	200
More than 750 up to 1,000	160
Above 1,000	100

Further to the circular, at the Initial Public Offer stage the Registrar to Issue in consultation with Book Running Lead Manager, our Company and BSE shall ensure to finalize the basis of allotment in minimum lots and in multiples of minimum lot size, as per the above given table. The secondary market trading lot size shall be the same, as shall be the IPO Lot Size at the application/allotment stage, facilitating secondary market trading. At the Initial Public Offering stage if the price band decided, falls within two different price bands than the minimum application lot size shall be decided based on the price band in which the higher price falls into. For example: if the proposed price band is at 24-28 then the Lot size shall be 4,000 shares.



## ISSUE PROCEDURE

All Applicants should read the General Information Document for Investing in Public Issues prepared and issued in accordance with the circulars issued by the SEBI, including circular CIR/CFD/DIL/12/2013 dated October 23, 2013 notified by SEBI and updated pursuant to the circular CIR/CFD/POLICYCELL/11/2015 dated November 10, 2015, the circular SEBI/HO/CFD/DIL/CIR/P/2016/26 dated January 21, 2016, the circular SEBI/HO/CFD/DIL2/CIR/P/2018/138 dated November 1, 2018, circular no. SEBI/HO/CFD/DIL2/CIR/P/2019/50 dated April 3, 2019, circular no. SEBI/HO/CFD/DIL2/CIR/P/2019/76 dated June 28, 2019, circular no. SEBI/HO/CFD/DIL2/CIR/P/2019/85 dated July 26, 2019, circular SEBI/HO/CFD/DIL2/CIR/P/2019/133 dated November 8, 2019 and the circular SEBI/HO/CFD/DIL2/CIR/P/2020/50 dated March 30, 2020 (the “General Information Document”), which highlights the key rules, processes and procedures applicable to public issues in general in accordance with the provisions of the Companies Act, the Securities contracts (Regulation) Act, 1956, the Securities Contracts (Regulation) Rules, 1957, and the SEBI Regulations. The General Information Document is available on the websites of the Stock Exchanges and the LMs. Please refer to the relevant provisions of the General Information Document which are applicable to the Issue. Especially in relation to the process for Applications by Retail Individual Applicants through the UPI Mechanism. The investors should note that the details and process provided in the General Information Document should be read along with this section

Additionally, all Applicants may refer to the General Information Document for information in relation to (i) Category of investor eligible to participate in the Issue; (ii) maximum and minimum Application size; (iii) price discovery and allocation; (iv) Payment Instructions for ASBA Applicants; (v) Issuance of CAN and Allotment in the Issue; (vi) General instructions (limited to instructions for completing the Application Form); (vii) designated date; (viii) disposal of applications; (ix) submission of Application Form; (x) other instructions (limited to joint applications in cases of individual, multiple applications and instances when an application would be rejected on technical grounds); (xi) applicable provisions of Companies Act, 2013 relating to punishment for fictitious applications; (xii) mode of making refunds; and (xiv) interest in case of delay in Allotment or refund.

All Designated Intermediaries in relation to the Issue should ensure compliance with the SEBI circular (CIR/CFD/POLICYCELL/11/2015) dated November 10, 2015, as amended and modified by the SEBI circular (SEBI/HO/CFD/DIL/CIR/P/2016/26) dated January 21, 2016 and SEBI circular (SEBI/HO/CFD/DIL2/CIR/P/2018/22) dated February 15, 2018 and (SEBI/HO/CFD/DIL2/CIR/P/2018/138) dated November 1, 2018, in relation to clarifications on streamlining the process of public issue of equity shares and convertibles as amended and modified by the SEBI circular no. SEBI/HO/CFD/DIL2/CIR/P/2019/50 dated April 3, 2019, circular no. SEBI/HO/CFD/DIL2/CIR/P/2019/76 June 28, 2019, circular no. SEBI/HO/CFD/DIL2/CIR/P/2019/85 dated July 26, 2019 and circular no. SEBI/HO/CFD/DCR2/CIR/P/2019/133 dated November 8, 2019

SEBI through its circular no. (SEBI/HO/CFD/DIL2/CIR/P/ 2018/138) dated November 1, 2018 read with its circular no. SEBI/HO/CFD/DIL2/CIR/P/2019/50 dated April 3, 2019 and circular no. (SEBI/HO/CFD/DIL2/CIR/P/2019/76) dated June 28, 2019, has introduced an alternate payment mechanism using Unified Payments Interface (“UPI”) and consequent reduction in timelines for listing in a phased manner. From January 1, 2019, the UPI mechanisms for RIIs applying through Designated Intermediaries were made effective along with the existing process and existing timeline of T+6 days. (“UPI Phase I”) The UPI Phase I was effective till June 30, 2019.

With effect from July 1, 2019, with respect to Applications by RIBs through Designated Intermediaries (other than SCSBs), the existing process of physical movement of forms from such Designated Intermediaries to SCSBs for blocking of funds has been discontinued and only the UPI Mechanism for such Application with existing timeline of T+6 days will continue for a period of three months or launch of five main board public issues, whichever is later (“UPI Phase II”). Further, pursuant to SEBI circular SEBI/HO/CFD/DCR2/CIR/P/2019/133 dated November 8, 2019, the UPI Phase II was extended until March 31, 2020. Further still, as per SEBI circular SEBI/HO/CFD/DIL2/CIR/P/2020/50 dated March 30, 2020, Thereafter, the final reduced timeline of T+3 days may be made effective using the UPI Mechanism for applications by Retail Individual Investors (“UPI Phase III”), as may be prescribed by SEBI. Accordingly, the Issue has been considered to be made under UPI Phase II, till any further notice issued by SEBI. Further, SEBI, vide its circular no. SEBI/HO/CFD/DIL2/CIR/P/2021/2480/1/M dated March 16, 2021, and circular no. SEBI/HO/CFD/DIL2/P/CIR/2021/570 dated June 2, 2021, has introduced certain additional measures for streamlining the process of initial public offers and redressing investor grievances. These circulars, to the extent already in force, are deemed to form part of this Prospectus. If the Issue is made under UPI Phase III, the same will be advertised in all editions of the English national daily newspaper, all editions of the Hindi national daily newspaper, regional edition of the regional daily newspaper on or prior to the Issue Opening Date and such advertisement shall also be made available to the Stock Exchange for the purpose of uploading on their website.

In case of any delay in unblocking of amounts in the ASBA Accounts (including amounts blocked through the UPI Mechanism) exceeding four Working Days from the Issue Closing Date, the Applicants shall be compensated at a uniform rate of ₹100 per day for the entire duration of delay exceeding four Working Days from the Issue Closing Date by the intermediary responsible for causing such delay in unblocking. The LM shall, in their sole discretion, identify and fix the liability on such intermediary or entity responsible for such delay in unblocking. Further, SEBI vide its circular no. SEBI/HO/CFD/DIL1/CIR/P/2021/47 dated March 31, 2021, has reduced the timelines for refund of Application money to four days

Please note that the information stated/covered in this section may not be complete and/or accurate and as such would be subject to modification/change. Our Company and Lead Manager do not accept any responsibility for the completeness and accuracy of the information stated in this section and the General Information Document and would not be liable for any amendment, modification or change in applicable law, which may occur after the date of this Prospectus. Applicants are advised to make their independent investigations and ensure that their Application are submitted in accordance with applicable laws and do not exceed the investment limits or maximum number of Equity Shares that can be held by them under applicable law or as specified in draft Prospectus and the Prospectus.

This section applies to all the Applicants, please note that all the Applicants are required to make payment of the full Application Amount along with the Application Form. Further, the Company and the Lead Manager are not liable for any adverse occurrences consequent to the implementation of the UPI Mechanism for application in this Issue.

#### ***Phased implementation of Unified Payments Interface***

SEBI has issued a circular bearing number SEBI/HO/CFD/DIL2/CIR/P/2018/138 dated November 1, 2018, circular no. SEBI/HO/CFD/DIL2/CIR/P/2019/50 dated April 3, 2019 circular no. SEBI/HO/CFD/DIL2/CIR/P/2019/76 dated June 28, 2019, circular no. SEBI/HO/CFD/DIL2/CIR/P/2019/85 dated July 26, 2019, circular no. SEBI/HO/CFD/DCR2/CIR/P/2019/133 dated November 08, 2019 and circular SEBI/HO/CFD/DIL2/CIR/P/2020/50 dated March 30, 2020 (collectively the “**UPI Circulars**”) in relation to streamlining the process of public issue of equity shares and convertibles. Pursuant to the UPI Circulars, the UPI Mechanism has been introduced in a phased manner as a payment mechanism (in addition to mechanism of blocking funds in the account maintained with SCSBs under the ASBA) for applications by RIIs through intermediaries with the objective to reduce the time duration from public issue closure to listing from six working days to up to three working days. Considering the time required for making necessary changes to the systems and to ensure complete and smooth transition to the UPI Mechanism, the UPI Circular proposes to introduce and implement the UPI Mechanism in three phases in the following manner:

**Phase I:** This phase has become applicable from January 1, 2019 until March 31, 2019 or floating of five main board public issues, whichever is later. Subsequently, the timeline for implementation of Phase I was extended till June 30, 2019. Under this phase, a Retail Individual Applicant had the option to submit the Application Form with any of the intermediary and use his / her UPI ID for the purpose of blocking of funds. The time duration from public issue closure to listing continued to be six Working Days.

**Phase II:** This phase has become applicable from July 1, 2019 and was to initially continue for a period of three months or floating of five main board public issues, whichever is later. Subsequently, it was decided to extend the timeline for implementation of Phase II until March 31, 2020. Further, as per SEBI circular SEBI/HO/CFD/DIL2/CIR/P/2020/50 dated March 30, 2020; the current Phase II of Unified Payments Interface with Application Supported by Blocked Amount is continued till further notice. Under this phase, submission of the ASBA Form by RIIs through Designated Intermediaries (other than SCSBs) to SCSBs for blocking of funds will be discontinued and will be replaced by the UPI payment mechanism. However, the time duration from public issue closure to listing continues to be six Working Days during this phase.

**Phase III:** The commencement period of Phase III is yet to be notified. In this phase, the time duration from public issue closure to listing is proposed to be reduced to three Working Days.

All SCSBs offering facility of making application in public issues shall also provide facility to make application using the UPI Mechanism. The Issuers will be required to appoint one of the SCSBs as a sponsor bank to act as a conduit between the Stock Exchanges and NPCI in order to facilitate collection of requests and / or payment instructions of the Retail Individual Applicants into the UPI mechanism.

For further details, refer to the General Information Document available on the websites of the Stock Exchanges and the Lead Manager.

## FIXED PRICE ISSUE PROCEDURE

The Issue is being made in compliance with the provisions of Reg. 229(1) of Chapter IX of the SEBI (ICDR) Regulations, 2018 and through the Fixed Price Process wherein 50% of the Net Issue to Public is being offered to the Retail Individual Applicants and the balance shall be offered to Non Retail Category i.e. QIBs and Non-Institutional Applicants. However, if the aggregate demand from the Retail Individual Applicants is less than 50%, then the balance Equity Shares in that portion will be added to the non retail portion offered to the remaining investors including QIBs and NIIs and vice-versa subject compliance with Regulation 253(2) of the SEBI ICDR Regulations and subject to valid Applications being received from them at or above the Issue Price.

Subject to the valid Applications being received at or above the Issue Price, allocation to all categories in the Net Issue, shall be made on a proportionate basis, except for the Retail Portion where Allotment to each Retail Individual Applicants shall not be less than the minimum lot, subject to availability of Equity Shares in Retail Portion, and the remaining available Equity Shares, if any, shall be allotted on a proportionate basis. Under subscription, if any, in any category, would be allowed to be met with spill over from any other category or a combination of categories at the discretion of our Company in consultation with the Lead Manager and the Stock Exchange.

**Investors should note that according to section 29(1) of the Companies Act, 2013, allotment of Equity Shares to all successful Applicants will only be in the dematerialised form. The Application Forms which do not have the details of the Applicant's depository account including DP ID, PAN and Beneficiary Account Number/UPI ID (for RII Applicants using the UPI Mechanism) shall be treated as incomplete and rejected. In case DP ID, Client ID and PAN mentioned in the Application Form and entered into the electronic system of the stock exchanges, do not match with the DP ID, Client ID and PAN available in the depository database, the application is liable to be rejected. Applicants will not have the option of getting allotment of the Equity Shares in physical form. However, the specified securities may be rematerialised subsequent to allotment by the investor. The Equity Shares on allotment shall be traded only in the dematerialised segment of the Stock Exchanges.**

## APPLICATION FORM

Copies of the Application Form and the abridged prospectus will be available at the offices of the Lead Manager, the Designated Intermediaries, and the Registered Office of our Company. An electronic copy of the Application Form will also be available for download on the websites of the BSE ([www.bseindia.com](http://www.bseindia.com)), the SCSBs, the Registered Brokers, the RTAs and the CDPs at least one day prior to the Issue Opening Date.

All Applicants shall mandatorily participate in the Issue only through the ASBA process. ASBA Applicants (other than Applicants using the UPI Mechanism) must provide bank account details and authorisation to block funds in the relevant space provided in the Application Form and the Application Forms that do not contain such details are liable to be rejected. Further Retail Individual Applicants may participate in the Issue through UPI by providing details in the relevant space provided in the Application Form and the Application Forms that do not contain the UPI ID are liable to be rejected.

Retail Individual Investors submitting their application form to any Designated Intermediaries (other than SCSBs) shall be required to apply using the UPI Mechanism and must provide the UPI ID in the relevant space provided in the Application Form. Retail Individual Investors submitting their application form to any Designated Intermediaries (other than SCSBs) failed to mention UPI ID are liable to be rejected. Retail Individual Investors may also apply through the SCSBs and mobile applications using the UPI handles as provided on the website of the SEBI.

ASBA Applicants shall ensure that the Applications are made on Application Forms bearing the stamp of the Designated Intermediary, submitted at the Collection Centres only (except in case of Electronic Application Forms) and the Application Forms not bearing such specified stamp are liable to be rejected.

The prescribed colour of the Application Form for various categories is as follows:

Category	Colour <sup>(1)</sup>
Resident Indians and Eligible NRIs applying on a non-repatriation basis	White
Non-Residents and Eligible NRIs, FIIs, FVCIs, etc. applying on a repatriation basis	Blue

<sup>(1)</sup> Excluding electronic Application Form

Designated Intermediaries (other than SCSBs) shall submit/deliver the Application Form (except the Application Form from a RIIs using the UPI mechanism) to the respective SCSB, where the Applicant has a bank account and shall not

submit it to any non-SCSB bank or any Escrow Bank. Further, SCSBs shall upload the relevant Application details (including UPI ID in case of ASBA Forms under the UPI Mechanism) in the electronic Applying system of the Stock Exchange. Stock Exchange shall validate the electronic Applications with the records of the CDP for DP ID/Client ID and PAN, on a real time basis and bring inconsistencies to the notice of the relevant Designated Intermediaries, for rectification and re-submission within the time specified by Stock Exchange. Stock Exchange shall allow modification of either DP ID/Client ID or PAN ID, bank code and location code in the Application details already uploaded

For RIIs using UPI mechanism, the Stock Exchanges shall share the Application details (including UPI ID) with the Sponsor Bank on a continuous basis to enable the Sponsor Bank to initiate UPI Mandate Request to RIIs for blocking of funds. The Sponsor Bank shall initiate request for blocking of funds through NPCI to RIIs, who shall accept the UPI Mandate Request for blocking of funds on their respective mobile applications associated with UPI ID linked bank account. The NPCI shall maintain an audit trail for every Application entered in the Stock Exchange applying platform, and the liability to compensate RIIs (using the UPI Mechanism) in case of failed transactions shall be with the concerned entity (i.e. the Sponsor Bank, NPCI or the Bankers to the Issue) at whose end the lifecycle of the transaction has come to a halt. The NPCI shall share the audit trail of all disputed transactions/ investor complaints to the Sponsor Banks and the Bankers to the Issue. The LM shall also be required to obtain the audit trail from the Sponsor Banks and the Bankers to the Issue for analysing the same and fixing liability. For ensuring timely information to investors, SCSBs shall send SMS alerts as specified in SEBI circular no. SEBI/HO/CFD/DIL2/CIR/P/2021/2480/1/M dated March 16, 2021, as amended pursuant to SEBI circular no. SEBI/HO/CFD/DIL2/P/CIR/2021/570 dated June 2, 2021.

The Sponsor Bank will undertake a reconciliation of Application responses received from Stock Exchanges and sent to NPCI and will also ensure that all the responses received from NPCI are sent to the Stock Exchanges platform with detailed error code and description, if any. Further, the Sponsor Bank will undertake reconciliation of all Application requests and responses throughout their lifecycle on daily basis and share reports with the LM in the format and within the timelines as specified under the UPI Circulars. Sponsor Bank and Issuer banks shall download UPI settlement files and raw data files from the NPCI portal after every settlement cycle and do a three way reconciliation with Banks UPI switch data, CBS data and UPI raw data. NPCI is to coordinate with Issuer banks and Sponsor Banks on a continuous basis

### **Electronic registration of Applications**

The Designated Intermediary may register the Applications using the on-line facilities of the Stock Exchanges. The Designated Intermediaries can also set up facilities for off-line electronic registration of Applications, subject to the condition that they may subsequently upload the off-line data file into the on-line facilities for Issue on a regular basis before the closure of the Issue.

On the Issue Closing Date, the Designated Intermediaries may upload the Applications till such time as may be permitted by the Stock Exchanges and as disclosed in the Prospectus.

Only Applications that are uploaded on the Stock Exchanges Platform are considered for allocation/Allotment. The Designated Intermediaries are given till 1:00 pm on the next working day following the Issue Closing Date to modify select fields uploaded in the Stock Exchange Platform during the Issue Period after which the Stock Exchange(s) send the Application information to the Registrar to the Issue for further processing

**The Equity Shares have not been and will not be registered under the U.S. Securities Act of 1933, as amended (the “U.S. Securities Act”) or any state securities laws in the United States and may not be offered or sold within the United States or to, or for the account or benefit of, U.S. persons (as defined in Regulation S) except pursuant to an exemption from, or in a transaction not subject to, the registration requirements of the U.S. Securities Act and applicable state securities laws in the United States. Accordingly, the Equity Shares are being offered and sold outside the United States in offshore transactions in compliance with Regulation S under the U.S. Securities Act and the applicable laws of the jurisdiction where those offers and sales occur.**

**The Equity Shares have not been and will not be registered, listed or otherwise qualified in any other jurisdiction outside India and may not be offered or sold, and Applications may not be made by persons in any such jurisdiction, except in compliance with the applicable laws of such jurisdiction.**

### **Who Can Apply?**

In addition to the category of Applicants set forth in the *General Information Document*, the following persons are also eligible to invest in the Equity Shares under all applicable laws, regulations and guidelines:

- Scientific and/or industrial research organizations in India, which are authorised to invest in equity shares; and
- Any other person eligible to apply in this Issue, under the laws, rules, regulations, guidelines and policies applicable to them.

#### **PARTICIPATION BY ASSOCIATES/AFFILIATES OF LEAD MANAGER, PROMOTERS, PROMOTER GROUP AND PERSONS RELATED TO PROMOTER/PROMOTER GROUP**

The Lead Manager shall not be entitled to subscribe to this Issue in any manner except towards fulfilling their underwriting obligations. However, associates and affiliates of the Lead Manager may subscribe to Equity Shares in the Issue, either in the QIB Portion and Non-Institutional Portion where the allotment is on a proportionate basis.

The Promoters, Promoter Group, Lead Manager and any persons related to the Lead Manager (except Mutual Funds sponsored by entities related to the Lead Manager) cannot apply in the Issue.

#### **APPLICATION BY MUTUAL FUNDS**

As per the current regulations, the following restrictions are applicable for investments by mutual funds:

No mutual fund scheme shall invest more than 10% of its net asset value in the Equity Shares or equity related instruments of any Company provided that the limit of 10% shall not be applicable for investments in index funds or sector or industry specific funds. No mutual fund under all its schemes should own more than 10% of any Company's paid up share capital carrying voting rights.

The Applications made by the asset management companies or custodians of Mutual Funds shall specifically state the names of the concerned schemes for which the Applications are made.

With respect to Applications by Mutual Funds, a certified copy of their SEBI registration certificate must be lodged with the Application Form. Failing this, our Company reserves the right to accept or reject any Application in whole or in part, in either case, without assigning any reason thereof.

In case of a Mutual Fund, a separate Application can be made in respect of each scheme of the Mutual Fund registered with SEBI and such Applications in respect of more than one scheme of the Mutual Fund will not be treated as multiple Applications provided that the Applications clearly indicate the scheme concerned for which the Application has been made.

#### **APPLICATION by HUFs**

Applications by HUFs Hindu Undivided Families or HUFs, in the individual name of the Karta. The Applicant should specify that the Application is being made in the name of the HUF in the Application Form as follows: "Name of sole or first Applicant: XYZ Hindu Undivided Family applying through XYZ, where XYZ is the name of the Karta". Applications by HUFs may be considered at par with Applications from individuals.

#### **APPLICATION BY ELIGIBLE NRIs**

Eligible NRIs may obtain copies of Application Form from the Designated Intermediaries. Only Applications accompanied by payment in Indian Rupees or freely convertible foreign exchange will be considered for Allotment. Eligible NRI Applicant applying on a repatriation basis by using the Non-Resident Forms should authorize their SCSB to or should confirm/accept the UPI Mandate Request (in case of RIIs using the UPI Mechanism) block their Non-Resident External ("NRE") accounts, or Foreign Currency Non-Resident ("FCNR") ASBA Accounts, and eligible NRI Applicant applying on a non-repatriation basis by using Resident Forms should authorize their SCSB or should confirm/accept the UPI Mandate Request (in case of RIIs applying using the UPI Mechanism) to block their Non-Resident Ordinary ("NRO") accounts for the full Application Amount, at the time of the submission of the Application Form. However, NRIs applying in the Issue through the UPI Mechanism are advised to enquire with the relevant bank where their account is UPI linked prior to submitting their Application.

Eligible NRIs applying on a repatriation basis are advised to use the Application Form meant for Non- Residents (blue in colour).

Eligible NRIs applying on non-repatriation basis are advised to use the Application Form for residents. (White in colour).

#### **APPLICATION BY INDIAN PUBLIC INCLUDING ELIGIBLE NRIS APPLYING ON NON-REPATRIATION**

Application must be made only in the names of individuals, limited companies or statutory corporations / institutions and not in the names of minors (other than minor having valid depository accounts as per demographic details provided by the depository), foreign nationals, non-residents (except for those applying on non-repatriation), trusts, (unless the trust is registered under the Societies Registration Act, 1860 or any other applicable trust laws and is authorized under its constitution to hold shares and debentures in a company), Hindu Undivided Families (HUF), partnership firms or their nominees. In case of HUFs, application shall be made by the Karta of the HUF.

Eligible NRIs applying on a non-repatriation basis may make payments by inward remittance in foreign exchange through normal banking channels or by debits to NRE / FCNR accounts as well as NRO accounts.

An applicant in the Net Public Category cannot make an application for that number of Equity Shares exceeding the number of Equity Shares offered to the public.

#### **APPLICATION BY FPI AND FIIs**

In terms of the SEBI FPI Regulations, any qualified foreign investor or FII who holds a valid certificate of registration from SEBI shall be deemed to be an FPI until the expiry of the block of three years for which fees have been paid as per the SEBI FII Regulations. An FII or a sub-account may participate in this Issue, in accordance with Schedule 2 of the FEMA Regulations, until the expiry of its registration with SEBI as an FII or a sub-account. An FII shall not be eligible to invest as an FII after registering as an FPI under the SEBI FPI Regulations.

In case of Applications made by FPIs, a certified copy of the certificate of registration issued by the designated depository participant under the FPI Regulations is required to be attached to the Application Form, failing which our Company reserves the right to reject any Application without assigning any reason. An FII or subaccount may, subject to payment of conversion fees under the SEBI FPI Regulations, participate in the Issue, until the expiry of its registration as a FII or sub-account, or until it obtains a certificate of registration as FPI, whichever is earlier. Further, in case of Applications made by SEBI-registered FIIs or sub-accounts, which are not registered as FPIs, a certified copy of the certificate of registration as an FII issued by SEBI is required to be attached to the Application Form, failing which our Company reserves the right to reject any Application without assigning any reason.

In terms of the SEBI FPI Regulations, the Issue of Equity Shares to a single FPI or an investor group (which means the same set of ultimate beneficial owner(s) investing through multiple entities) must be below 10.00% of our post- Issue Equity Share capital. Further, in terms of the FEMA Regulations, the total holding by each FPI shall be below 10.00% of the total paid-up Equity Share capital of our Company and the total holdings of all FPIs put together shall not exceed 24% of the paid-up Equity Share capital of our Company. The aggregate limit of 24% may be increased up to the sectorial cap by way of a resolution passed by the Board of Directors followed by a special resolution passed by the Shareholders of our Company and subject to prior intimation to RBI. In terms of the FEMA Regulations, for calculating the aggregate holding of FPIs in a company, holding of all registered FPIs as well as holding of FIIs (being deemed FPIs) shall be included. The existing individual and aggregate investment limits an FII or sub account in our Company is 10.00% and 24% of the total paid-up Equity Share capital of our Company, respectively.

FPIs are permitted to participate in the Issue subject to compliance with conditions and restrictions which may be specified by the Government from time to time.

Subject to compliance with all applicable Indian laws, rules, regulations, guidelines and approvals in terms of Regulation 21 of the SEBI FPI Regulations, only Category I FPIs, may issue, subscribe to or otherwise deal in offshore derivative instruments (as defined under the SEBI FPI Regulations as any instrument, by whatever name called, which is issued overseas by an FPI against securities held by it that are listed or proposed to be listed on any recognised stock exchange In India, as its underlying) directly or indirectly, only in the event (i) such offshore derivate instruments are issued only to persons eligible to be registered as Category I FPIs; and (ii) such offshore derivative instruments are issued after compliance with 'know your client' norms. An FPI may transfer offshore derivative instruments to persons compliant with the requirements of Regulation 21(1) of the SEBI FPI Regulations and subject to receipt of consent except where pre - approval is provided.

FPIs who wish to participate in the Issue are advised to use the Application Form for Non-Residents (blue in colour).

### **APPLICATION BY SEBI REGISTERED ALTERNATIVE INVESTMENT FUND (AIF), VENTURE CAPITAL FUNDS (VCF) AND FOREIGN VENTURE CAPITAL INVESTORS (FVCI)**

The SEBI VCF Regulations, the SEBI FVCI Regulations and the SEBI AIF Regulations inter-alia prescribe the investment restrictions on the VCFs, FVCIs and AIFs registered with SEBI. Further, the SEBI AIF Regulations prescribe, among others, the investment restrictions on AIFs.

The holding by any individual VCF or FVCI registered with SEBI in one venture capital undertaking should not exceed 25% of the corpus of the VCF. Further, VCFs and FVCIs can invest only up to 33.33% of the investible funds by way of subscription to an initial public offering.

The category I and II AIFs cannot invest more than 25% of the corpus in one Investee Company. A category III AIF cannot invest more than 10% of the corpus in one Investee Company. A venture capital fund registered as a category I AIF, as defined in the SEBI AIF Regulations, cannot invest more than 1/3rd of its corpus by way of subscription to an initial public offering of a venture capital undertaking. Additionally, the VCFs which have not re-registered as an AIF under the SEBI AIF Regulations shall continue to be regulated by the VCF Regulation until the existing fund or scheme managed by the fund is wound up and such funds shall not launch any new scheme after the notification of the SEBI AIF Regulations.

All FIIs and FVCIs should note that refunds, dividends and other distributions, if any, will be payable in Indian Rupees only and net of Bank charges and commission.

**Our Company or the Lead Manager will not be responsible for loss, if any, incurred by the Applicant on account of conversion of foreign currency.**

**There is no reservation for Eligible NRIs, FPIs and FVCIs and all Applicants will be treated on the same basis with other categories for the purpose of allocation.**

### **APPLICATIONS BY LIMITED LIABILITY PARTNERSHIPS**

In case of applications made by limited liability partnerships registered under the Limited Liability Partnership Act, 2008, a certified copy of certificate of registration issued under the Limited Liability Partnership Act, 2008, must be attached to the Application Form. Failing which, the Company, in consultation with the Lead Manager, reserves the right to reject any application, without assigning any reason thereof.

### **APPLICATIONS BY INSURANCE COMPANIES**

In case of Applications made by insurance companies registered with the IRDA, a certified copy of certificate of registration issued by IRDA must be attached to the Application Form. Failing this, our Company, in consultation with the Lead Manager, reserves the right to reject any Application without assigning any reason thereof.

The exposure norms for insurers prescribed in Regulation 9 of the Insurance Regulatory and Development Authority of India (Investment) Regulations, 2016 ("IRDAI Investment Regulations") are set forth below:

- a. Equity shares of a company: the lower of 10%<sup>(1)</sup> of the investee company's outstanding equity shares (face value) or 10% of the respective fund in case of a life insurer/ or 10% of investment assets in case of a general insurer or a reinsurer;
- b. The entire group of the investee company: not more than 15% of the respective fund in case of a life insurer or 15% of investment assets in case of a general insurer or a reinsurer or 15% of the investment assets in all companies belonging to the group, whichever is lower; and
- c. The industry sector in which the investee company operates: not more than 15% of the respective fund of a life insurer or a reinsurer or health insurer general insurance or 15% of the investment assets, whichever is lower.

The maximum exposure limit, in the case of an investment in equity shares, cannot exceed the lower of an amount of 10% of the investment assets of a life insurer or general insurer and the amount calculated under points (i), (ii) or (iii) above, as the case may be.

<sup>(1)</sup> The above limit of 10% shall stand substituted as 15% of outstanding equity shares (face value) for insurance companies with investment assets of Rs. 2,500,000 million or more and 12% of outstanding equity shares (face value) for insurers with investment assets of Rs. 500,000 million or more but less than Rs. 2,500,000 million.

Insurer companies participating in this Issue shall comply with all applicable regulations, guidelines and circulars issued by the IRDA from time to time including the Insurance Regulatory and Development Authority (Investment) Regulations, 2016 (“**IRDA Investment Regulations**”).

#### **APPLICATION BY PROVIDENT FUNDS / PENSION FUNDS**

In case of applications made by provident funds/pension funds, subject to applicable laws, with minimum corpus of ₹ 25 Crores, a certified copy of certificate from a chartered accountant certifying the corpus of the provident fund/pension fund must be attached to the Application Form. Failing this, the Company reserves the right to reject any application, without assigning any reason thereof.

#### **APPLICATION BY SYSTEMICALLY IMPORTANT NON-BANKING FINANCIAL COMPANIES**

In case of Applications made by systemically important non-banking financial companies, a certified copy of the certificate of registration issued by the RBI, a certified copy of its last audited financial statements on a standalone basis and a net worth certificate from its statutory auditor(s), must be attached to the Application Form. Failing this, our Company, in consultation with the Lead Manager, reserves the right to reject any Application, without assigning any reason thereof. Systemically Important Non Banking Financial Companies participating in the Issue shall comply with all applicable regulations, guidelines and circulars issued by RBI from time to time.

#### **APPLICATIONS BY BANKING COMPANIES**

In case of Applications made by banking companies registered with RBI, certified copies of: (i) the certificate of registration issued by RBI, and (ii) the approval of such banking company’s investment committee are required to be attached to the Application Form, failing which our Company, in consultation with the Lead Manager, reserve the right to reject any Application without assigning any reason.

The investment limit for banking companies in non-financial services companies as per the Banking Regulation Act, 1949, as amended ("Banking Regulation Act"), and the Reserve Bank of India ("Financial Services provided by Banks") Directions, 2016, is 10% of the paid-up share capital of the investee company not being its subsidiary engaged in non-financial services or 10% of the banks own paid-up share capital and reserves, whichever is lower. However, a banking company would be permitted to invest in excess of 10% but not exceeding 30% of the paid up share capital of such investee company if (i) the investee company is engaged in non-financial activities permitted for banks in terms of Section 6(1) of the Banking Regulation Act, or (ii) the additional acquisition is through restructuring of debt / corporate debt restructuring / strategic debt restructuring, or to protect the banks ‘interest on loans / investments made to a company. The bank is required to submit a time bound action plan for disposal of such shares within a specified period to RBI. A banking company would require a prior approval of RBI to make (i) investment in a subsidiary and a financial services company that is not a subsidiary (with certain exception prescribed), and (ii) investment in a non-financial services company in excess of 10% of such investee company’s paid up share capital as stated in 5(a) (v) (c) (i) of the Reserve Bank of India (Financial Services provided by Banks) Directions, 2016. Further, the aggregate investment by a banking company in subsidiaries and other entities engaged in financial and non-financial services company cannot exceed 20% of the investee company’s paid-up share capital and reserves.

#### **APPLICATIONS BY SCSBS**

SCSBS participating in the Issue are required to comply with the terms of the SEBI circulars dated September 13, 2012 and January 2, 2013. Such SCSBs are required to ensure that for making applications on their own account using ASBA, they should have a separate account in their own name with any other SEBI registered SCSBs. Further, such account shall be used solely for the purpose of making application in public issues and clear demarcated funds should be available in such account for such applications.

#### **APPLICATION UNDER POWER OF ATTORNEY**

In case of Applications made pursuant to a power of attorney by limited companies, corporate bodies, registered societies, Eligible FPIs, AIFs, Mutual Funds, insurance companies, insurance funds set up by the army, navy or air



force of India, insurance funds set up by the Department of Posts, India or the National Investment Fund and provident funds with a minimum corpus of ₹ 250 million (subject to applicable law) and pension funds with a minimum corpus of ₹ 250 million (in each case, subject to applicable ), a certified copy of the power of attorney or the relevant resolution or authority, as the case may be, along with a certified copy of the memorandum of association and articles of association and/or bye laws, as applicable, must be lodged along with the Application Form. Failing this, our Company, in consultation with the Lead Manager reserves the right to accept or reject any Application in whole or in part, in either case, without assigning any reason thereof. Our Company in consultation with the Lead manager, in their absolute discretion, reserves the right to relax the above condition of simultaneous lodging of the power of attorney along with the Application Form.

***The above information is given for the benefit of the Applicants. The Company and the Lead Manager are not liable for any amendments or modification or changes in applicable laws or regulations, which may occur after the date of this Prospectus. Applicants are advised to make their independent investigations and ensure that the number of Equity Shares applied for do not exceed the applicable limits under laws or regulations.***

#### **Participation by associates and affiliates of the Lead Manager**

The Lead Manager shall not be allowed to subscribe to this Issue in any manner except towards fulfilling their underwriting obligations. However, the associates and affiliates of the Lead Manager may subscribe to Equity Shares in the Issue in non Retail Portion, where the allocation is on a proportionate basis.

#### **Pre- Issue Advertisement**

Subject to Section 30 of the Companies Act, our Company shall, after registering the Prospectus with the RoC, publish a pre-Issue advertisement, in the form prescribed by the SEBI Regulations, in one English language national daily newspaper, one Hindi language national daily newspaper and one regional language daily newspaper, each with wide circulation. In the pre- Issue advertisement, we shall state the Issue Opening Date and the Issue Closing Date. This advertisement, subject to the provisions of Section 30 of the Companies Act, 2013, shall be in the format prescribed in Part A of Schedule XIII of the SEBI Regulations.

#### **Signing of the Underwriting Agreement and the RoC Filing**

- a) Our Company, the Lead Manager and the Market Maker have entered into an Underwriting Agreement on March 09, 2022 and addendum dated June 02, 2022.
- b) For terms of the Underwriting Agreement please see chapter titled “*General Information*” beginning on page no. 39 of this Prospectus.
- c) We will file a copy of the Prospectus with the RoC in terms of Section 26 and all other provision applicable as per Companies Act.

#### **FILING OF THE PROSPECTUS WITH THE ROC**

Our Company shall file the Prospectus with the RoC at least three working days before the Issue Opening Date in terms of Section 26 of Companies Act, 2013.

#### **DESIGNATED DATE AND ALLOTMENT OF EQUITY SHARES DESIGNATED DATE**

On the Designated date, the SCSBs shall transfers the funds represented by allocations of the Equity Shares into Public Issue Account with the Bankers to the Issue.

#### **ISSUANCE OF ALLOTMENT ADVICE**

Upon approval of the Basis of Allotment by the designated stock exchange, the Registrar shall upload on its website. On the basis of approved basis of allotment, the Issuer shall pass necessary corporate action to facilitate the allotment and credit of equity shares. Applicants are advised to instruct their Depository Participants to accept the Equity Shares that may be allotted to them pursuant to the Issue.

Pursuant to confirmation of such corporate actions, the Registrar will dispatch Allotment Advice to the Applicants who have been allotted Equity Shares in the Issue. The dispatch of allotment advice shall be deemed a valid, binding and irrevocable contract.

Issuer will make the allotment of the equity shares and initiate corporate action for credit of shares to the successful applicants Depository Account within 4 working days of the Issue Closing date. The Issuer also ensures the credit of shares to the successful Applicants Depository Account is completed within one working Day from the date of allotment, after the funds are transferred from ASBA Public Issue Account to Public Issue account of the issuer.

**Designated Date:** On the Designated date, the SCSBs shall transfers the funds represented by allocations of the Equity Shares into Public Issue Account with the Bankers to the Issue.

The Company will issue and dispatch letters of allotment/ or letters of regret along with refund order or credit the allotted securities to the respective beneficiary accounts, if any within a period of 6 working days of the Issue Closing Date. The Company will intimate the details of allotment of securities to Depository immediately on allotment of securities under Section 56 of the Companies Act, 2013 or other applicable provisions, if any.

### **AVAILABILITY OF THE PROSPECTUS AND THE APPLICATION FORMS**

Copies of the Application Form and the abridged prospectus will be available at the offices of the Lead Manager, the Designated Intermediaries, and Registered Office of our Company. An electronic copy of the Application Form will also be available for download on the websites of the BSE ([www.bseindia.com](http://www.bseindia.com)), the SCSBs, the Registered Brokers, the RTAs and the CDPs at least one day prior to the Issue Opening Date.

### **INFORMATION FOR THE APPLICANTS**

In addition to the instructions provided to the Applicants in the *General Information Document for Investing in Public Offers*, Applicants are requested to note the following additional information in relation to the Issue.

1. The Issue Period shall be for a minimum of three Working Days and shall not exceed ten Working Days. The Issue Period may be extended, if required, by an additional three Working Days, subject to the total Issue Period not exceeding ten Working Days.
2. The relevant Designated Intermediary will enter each Application into the electronic Applying system as a separate Application and generate an acknowledgement slip (“Acknowledgement Slip”), for each price and demand option and give the same to the Applicant. Therefore, an Applicant can receive up to three Acknowledgement Slips for each Application Form. It is the Applicant’s responsibility to obtain the TRS from the relevant Designated Intermediary. The registration of the Application by the Designated Intermediary does not guarantee that the Equity Shares shall be allocated/ allotted. Such Acknowledgement will be non-negotiable and by itself will not create any obligation of any kind. When a Applicant revises his or her Application (in case of revision in the Price), he /she shall surrender the earlier Acknowledgement Slip and may request for a revised TRS from the relevant Designated Intermediary as proof of his or her having revised the previous Application.
3. In relation to electronic registration of Applications, the permission given by the Stock Exchanges to use their network and software of the Electronic Bidding System should not in any way be deemed or construed to mean that the compliance with various statutory and other requirements by our Company, and/or the Lead Manager are cleared or approved by the Stock Exchanges; nor does it in any manner warrant, certify or endorse the correctness or completeness of compliance with the statutory and other requirements, nor does it take any responsibility for the financial or other soundness of our Company, the management or any scheme or project of our Company; nor does it in any manner warrant, certify or endorse the correctness or completeness of any of the contents of this Prospectus or the Prospectus; nor does it warrant that the Equity Shares will be listed or will continue to be listed on the Stock Exchanges.
4. In the event of an upward revision in the Price, Retail Individual Applicants could either (i) revise their Application or (ii) shall make additional payment based on the revised Price (such that the total amount i.e., original Application Amount plus additional payment does not exceed Rs. 200,000. The revised Applications must be submitted to the same Designated Intermediary to whom the original Application was submitted. If the total amount (i.e., the original Application Amount plus additional payment) exceeds ₹ 200,000, the Applicant will be considered for allocation under the Non-Institutional Portion. If, however, the Retail Individual Applicant does not either revise the Application or make additional payment the number of Equity Shares applied for shall be adjusted

downwards for the purpose of allocation, such that no additional payment would be required from the Retail Individual Applicant and the Retail Individual Applicant is deemed to have approved such revised Application.

5. In the event of a downward revision in the Price, Retail Individual Applicant may revise their Application; otherwise, the excess amount paid at the time of Application would be unblocked after Allotment is finalised.
6. Any revision of the Application shall be accompanied by instructions to block the incremental amount, if any, to be paid on account of the upward revision of the Application.

**The Applicants should note that in case the PAN, the DP ID and Client ID mentioned in the Application Form and entered into the electronic system of the Stock Exchanges does not match with the PAN, DP ID and Client ID available in the database of Depositories, the Application Form is liable to be rejected.**

### **General Instructions**

Please note that QIBs and Non-Institutional Investors are not permitted to withdraw their Application(s) or lower the size of their Application(s) (in terms of quantity of Equity Shares or the Application Amount) at any stage. Retail Individual Applicants can revise their Application(s) during the Issue Period and withdraw their Application(s) until Issue Closing Date.

#### **Do's:**

- 1) Check if you are eligible to apply as per the terms of this Prospectus and under applicable law, rules, regulations, guidelines and approvals. All Applicants should submit their Applications through the ASBA process only;
- 2) Read all the instructions carefully and complete the Application Form in the prescribed form;
- 3) Ensure that the details about the PAN, DP ID and Client ID are correct and the Applicants depository account is active, as Allotment of the Equity Shares will be in the dematerialised form only;
- 4) Ensure that your Application Form bearing the stamp of a Designated Intermediary is submitted to the Designated Intermediary at the Application Centre (except in case of electronic Applications) within the prescribed time. Retail Individual Applicants using UPI Mechanism, may submit their ASBA Forms with Syndicate Members, Registered Brokers, RTA or Depository Participants;
- 5) If the first applicant is not the bank account holder, ensure that the Application Form is signed by the account holder. Ensure that you have mentioned the correct bank account number in the Application Form (for all Applicants other than Retail Individual Applicants, Applying using the UPI Mechanism);
- 6) Ensure that the signature of the First Applicant in case of joint Applications, is included in the Application Forms;
- 7) Ensure that the name(s) given in the Application Form is/are exactly the same as the name(s) in which the beneficiary account is held with the Depository Participant. In case of joint Applications, the Application Form should contain only the name of the First Applicant whose name should also appear as the first holder of the beneficiary account held in joint names;
- 8) Ensure that you request for and receive a stamped acknowledgement of your Application;
- 9) Retail Applicants using the UPI mechanism should ensure that the correct UPI ID is mentioned in the Application Form;
- 10) Instruct your respective banks to release the funds blocked in accordance with the ASBA process;
- 11) Submit revised Applications to the same Designated Intermediary, through whom the original Application was placed and obtain a revised acknowledgment;
- 12) Except for Applications (i) on behalf of the Central or State Governments and the officials appointed by the courts, who, in terms of a SEBI circular dated June 30, 2008, may be exempt from specifying their PAN for transacting in the securities market, and (ii) submitted by investors who are exempt from the requirement of obtaining / specifying their PAN for transacting in the securities market including without limitation, multilateral/ bilateral

institutions, and (iii) Applications by persons resident in the state of Sikkim, who, in terms of a SEBI circular dated July 20, 2006, may be exempted from specifying their PAN for transacting in the securities market, all Applicants should mention their PAN allotted under the IT Act. The exemption for the Central or the State Government and officials appointed by the courts and for investors residing in the State of Sikkim is subject to (a) the Demographic Details received from the respective depositories confirming the exemption granted to the beneficiary owner by a suitable description in the PAN field and the beneficiary account remaining in “active status”; and (b) in the case of residents of Sikkim, the address as per the Demographic Details evidencing the same. All other applications in which PAN is not mentioned will be rejected;

- 13) Ensure that the Demographic Details are updated, true and correct in all respects;
- 14) Ensure that thumb impressions and signatures other than in the languages specified in the Eighth Schedule to the Constitution of India are attested by a Magistrate or a Notary Public or a Special Executive Magistrate under official seal;
- 15) Ensure that the correct investor category and the investor status is indicated in the Application Form;
- 16) Ensure that in case of Applications under power of attorney or by limited companies, corporate, trust etc., relevant documents are submitted;
- 17) Ensure that Applications submitted by any person outside India should be in compliance with applicable foreign and Indian laws;
- 18) Applicants should note that in case the DP ID, Client ID and the PAN mentioned in their Application Form and entered into the online IPO system of the Stock Exchanges by the relevant Designated Intermediary, as the case may be, do not match with the DP ID, Client ID and PAN available in the Depository database, then such Applications are liable to be rejected. Where the Application Form is submitted in joint names, ensure that the beneficiary account is also held in the same joint names and such names are in the same sequence in which they appear in the Application Form;
- 19) Ensure that the Application Forms are delivered by the Applicants within the time prescribed as per the Application Form and the Prospectus;
- 20) In case of ASBA Applicants (other than Retail Individual Applicants using UPI Mechanism), ensure that while Applying through a Designated Intermediary, the ASBA Form is submitted to a Designated Intermediary in a Applying Centre and that the SCSB where the ASBA Account, as specified in the ASBA Form, is maintained has named at least one branch at that location for the Designated Intermediary to deposit ASBA Forms (a list of such branches is available on the website of SEBI at <http://www.sebi.gov.in>);
- 21) Once the Sponsor Bank issues the UPI Mandate Request, the Retail Individual Applicants would be required to proceed to authorise the blocking of funds by confirming or accepting the UPI Mandate Request;
- 22) Ensure that you have correctly signed the authorization / undertaking box in the Application Form, or have otherwise provided an authorisation to the SCSB or the Sponsor Bank, as applicable, via the electronic mode, for blocking funds in the ASBA Account equivalent to the Application Amount mentioned in the Application Form at the time of submission of the Application;
- 23) Retail Applicants shall ensure that details of the Applications are reviewed and verified by opening the attachment in the UPI mandate request and then proceed to authorize the UPI request using his/her UPI PIN. Upon the authorization of the mandate using his/her UPI PIN, a Retail Applicant may be deemed to have verified the attachment containing the application details of the Retail Applicant in the UPI mandate request and have agreed to block the entire Application Amount and authorized the Sponsor Bank to block the Application Amount mentioned in the Application Form;
- 24) Retail Applicants using the UPI mechanism should mention valid UPI ID of only the Applicant (in case of single account) and of the first Applicant (in case of joint account) in the Application Form;
- 25) Retail Applicants using the UPI mechanism, who have revised their Application subsequent to making the initial Application, should also approve the revised request generated by the Sponsor Bank to authorize blocking of funds equivalent to the revised Application Amount and subsequent debit of funds in case of allotment in a timely manner;

- 26) Ensure that you have correctly signed the authorisation/undertaking box in the Application Form, or have otherwise provided an authorisation to the SCSB or the Sponsor Bank, as applicable, via the electronic mode, for blocking funds in the ASBA Account equivalent to the Application Amount mentioned in the Application Form at the time of submission of the Application;
- 27) Ensure that you receive an acknowledgement from the concerned Designated Intermediary, for the submission of your Application Form; and
- 28) The Application Form is liable to be rejected if the above instructions, as applicable, are not complied with.

**Don'ts:**

- 1) Do not apply for lower than the minimum Application size;
- 2) Do not apply at a Price different from the Price mentioned herein or in the Application Form;
- 3) Do not apply by another Application Form after submission of Application to the Designated Intermediary.
- 4) Do not pay the Application Amount in cash, by money order, cheques or demand drafts or by postal order or by stock invest or any mode other than blocked amounts in the bank account maintained with SCSB;
- 5) Do not send Application Forms by post; instead submit the same to the Designated Intermediary only;
- 6) Do not submit the Application Forms to any non-SCSB bank or our Company;
- 7) Do not apply on a Application Form that does not have the stamp of the relevant Designated Intermediary;
- 8) Do not instruct your respective Banks to release the funds blocked in the ASBA Account under the ASBA process;
- 9) Do not apply for a Application Amount exceeding Rs. 200,000 (for Applications by Retail Individual Applicants);
- 10) Do not fill up the Application Form such that the Equity Shares applied for exceeds the Issue size and / or investment limit or maximum number of the Equity Shares that can be held under the applicable laws or regulations or maximum amount permissible under the applicable regulations or under the terms of this Prospectus;
- 11) Do not submit the General Index Register number instead of the PAN;
- 12) Do not submit incorrect details of the DP ID, Client ID and PAN or provide details for a beneficiary account which is suspended or for which details cannot be verified by the Registrar to the Issue;
- 13) Do not submit the Application without ensuring that funds equivalent to the entire Application Amount are blocked in the relevant ASBA Account;
- 14) Do not submit more than 1 Application Form for each UPI ID in case of Retail Applicants Applying through the Designated Intermediary using the UPI Mechanism;
- 15) If you are a Retail Individual Applicant and are using UPI Mechanism, do not make the ASBA application using third party bank account or using third party linked bank account UPI ID;
- 16) Do not submit Applications on plain paper or on incomplete or illegible Application Forms or on Application Forms in a colour prescribed for another category of Applicant;
- 17) Do not submit a Application in case you are not eligible to acquire Equity Shares under applicable law or your relevant constitutional documents or otherwise;
- 18) Do not apply if you are not competent to contract under the Indian Contract Act, 1872 (other than minors having valid depository accounts as per Demographic Details provided by the depository);

- 19) Do not withdraw your Application or lower the size of your Application (in terms of quantity of the Equity Shares or the Application Amount) at any stage, if you are a QIB or a Non-Institutional Applicant. Retail Individual Applicants can revise their Applications during the Offer Period and withdraw their Applications on or before the Offer Closing Date;
- 20) Do not apply for shares more than specified by respective Stock Exchanges for each category;
- 21) Do not link the UPI ID with a bank account maintained with a bank that is not UPI 2.0 certified by the NPCI in case of Applications submitted by Retail Applicants using the UPI mechanism;
- 22) Do not submit incorrect UPI ID details, if you are a Retail Applicants applying through UPI Mechanism;
- 23) Do not submit more than One Application Form per ASBA Account;
- 24) Do not submit an Application in case you are not eligible to acquire Equity Shares under applicable law or your relevant constitutional documents or otherwise
- 25) If you are a Non-Institutional Applicant or Retail Individual Applicant, do not submit your Application after 3.00 p.m. on the Issue Closing Date;

The Application Form is liable to be rejected if the above instructions, as applicable, are not complied with.

### **INSTRUCTIONS FOR COMPLETING THE APPLICATION FORM**

In addition to the instructions for completing the Application Form provided in the sub-section “*General Information Document for Investing in Public Offers – Applying in the Issue – Instructions for filing the Application Form / Application Form*” Applicants are requested to note the additional instructions provided below.

1. Thumb impressions and signatures other than in the languages specified in the Eighth Schedule in the Constitution of India must be attested by a Magistrate or a Notary Public or a Special Executive Magistrate under official seal. Applications must be in single name or in joint names (not more than three, and in the same order as their Depository Participant details).
2. Applications must be made in a single name or in joint names (not more than three, and in the same order as their details appear with the Depository Participant), and completed in full, in BLOCK LETTERS in ENGLISH and in accordance with the instructions contained in the Prospectus and in the Application Form.
3. Applications on a repatriation basis shall be in the names of FIIs or FPIs but not in the names of minors, OCBs, firms or partnerships and foreign nationals.

### **Payment instructions**

The entire Issue Price of ₹ 126 per Equity Share is payable on Application. In case of allotment of lesser number of Equity Shares than the number applied, then the Registrar shall instruct the SCSBs to unblock the excess amount paid on Application to the Applicants.

### **Issuance of a Confirmation of Allocation Note (“CAN”) and Allotment in the Issue**

1. Upon approval of the basis of allotment by the Designated Stock Exchange, the Lead Manager or Registrar to the Issue shall send to the SCSBs a list of their Applicants who have been allocated Equity Shares in the Issue.
2. The Registrar will then dispatch a CAN to their Applicants who have been allocated Equity Shares in the Issue. The dispatch of a CAN shall be deemed a valid, binding and irrevocable contract for the Applicant.

### **BASIS OF ALLOTMENT**

Allotment will be made in consultation with BSE Limited (The Designated Stock Exchange). In the event of oversubscription, the allotment will be made on a proportionate basis in marketable lots as set forth here:

1. The total number of Shares to be allocated to each category as a whole shall be arrived at on a proportionate basis i.e. the total number of Shares applied for in that category multiplied by the inverse of the over subscription ratio (number of applicants in the category x number of Shares applied for).
2. The number of Shares to be allocated to the successful applicants will be arrived at on a proportionate basis in marketable lots (i.e. Total number of Shares applied for into the inverse of the over subscription ratio).
3. For applications where the proportionate allotment works out to less than 1200 equity shares the allotment will be made as follows:
  - a) Each successful applicant shall be allotted 1,000 equity shares; and
  - b) The successful applicants out of the total applicants for that category shall be determined by the drawls of lots in such a manner that the total number of Shares allotted in that category is equal to the number of Shares worked out as per (2) above.
4. If the proportionate allotment to an applicant works out to a number that is not a multiple of 1,000 equity shares, the applicant would be allotted Shares by rounding off to the lower nearest multiple of 1,000 equity shares subject to a minimum allotment of 1,000 equity shares.
5. If the Shares allocated on a proportionate basis to any category is more than the Shares allotted to the applicants in that category, the balance available Shares for allocation shall be first adjusted against any category, where the allotted Shares are not sufficient for proportionate allotment to the successful applicants in that category, the balance Shares, if any, remaining after such adjustment will be added to the category comprising of applicants applying for the minimum number of Shares.
6. Since present Issue is a fixed price issue, the allocation in the net Issue to the public category in terms of Regulation 253 of the SEBI (ICDR) Regulations, 2018 shall be made as follows:
  - a) The 50% net Issue of shares to the Public (i.e. 2,38,000 Equity Shares) shall be made available for allotment to retail individual investors; and
  - b) The balance net Issue of shares to the public (i.e. 2,38,000 Equity Shares) shall be made available for allotment to Non-Institutional Investors, including Qualified Institution Buyers, Corporate Bodies/ Institutions.
  - c) The unsubscribed portion in either of the categories specified in (a) or (b) above may be allocated to the applicants in the other category.

Explanation: If the retails individual investor category is entitled to more than allocated portion on proportionate basis, the retails individual investors shall be allocated that higher percentage.

Please note that the Allotment to each Retail Individual Investor shall not be less than the minimum application lot, subject to availability of Equity Shares in the Retail portion. The remaining available Equity Shares, if any in Retail portion shall be allotted on a proportionate basis to Retail individual Investor in the manner in this Para titled “*Basis of Allotment*” on page no. 179 of this Prospectus.

“Retail Individual Investor” means an investor who applies for shares of value of not more than ₹ 2,00,000. Investors may note that in case of over subscription allotment shall be on proportionate basis and will be finalized in consultation with the National Stock Exchange of India Limited.

In the event of under subscription in the Issue, the obligations of the Underwriter shall get triggered in terms of the Underwriting Agreement. The Minimum subscription of 100% of the Issue size as specified shall be achieved before our company proceeds to get the basis of allotment approved by the Designated Stock Exchange.

The Executive Director/Managing Director/Authorised Signatory of the SME Platform of BSE Limited– the Designated Stock Exchange in addition to Lead Manager and Registrar to the Public Issue shall be responsible to ensure that the basis of allotment is finalized in a fair and proper manner in accordance with the SEBI (ICDR) Regulations, 2018.

## **RIGHT TO REJECT APPLICATIONS**

In case of QIB Applicants, the Company in consultation with the Lead Manager may reject Applications provided that the reasons for rejecting the same shall be provided to such Applicant in writing. In case of Non Institutional Applicants, Retail Individual Applicants who applied, the Company has a right to reject Applications based on technical grounds.

## **GROUND FOR REJECTIONS**

In addition to the grounds for rejection of Application on technical grounds as provided in the “*General Information Document for Investing in Public Offers*” Applicants are requested to note that Applications may be rejected on the following additional technical grounds.

1. Applications submitted without payment of the entire Application Amount;
2. Applications submitted by Applicants which do not contain details of the Application Amount and the bank account details / UPI ID in the Application Form;
3. Applications submitted on a plain paper;
4. Applications submitted by Retail Individual Applicants using the UPI Mechanism through an SCSBs and/or using a mobile application or UPI handle, not listed on the website of SEBI;
5. Applications submitted by Retail Individual Applications submitted by Applicants using third party bank accounts or using a third party linked bank account UPI ID;
6. Applications by HUFs not mentioned correctly as given in the sub-section “*Who can Apply?*” on page no. 179 of this Prospectus;
7. Application Form submitted to a Designated Intermediary does not bear the stamp of the Designated Intermediary;
8. Application submitted without the signature of the First Applicant or sole Applicants;
9. Applications by person for whom PAN details have not been verified and whose beneficiary accounts are ‘suspended for credit’ in terms of SEBI circular (reference number: CIR/MRD/DP/ 22 /2010) dated July 29, 2010;
10. GIR number furnished instead of PAN;
11. Application by Retail Individual Applicants with Application Amount for a value of more than ₹ 200,000
12. Applications by person who are not eligible to acquire Equity Shares in terms of all applicable laws, rules, regulations, guidelines and approvals;
13. Applications by Applicants (who are not Anchor Investors) accompanied by cheques or demand drafts;
14. Applications accompanied by stock invest, money order, postal order or cash;
15. Application by OCB.

## **EQUITY SHARES IN DEMATERIALIZED FORM WITH NSDL OR CDSL**

To enable all shareholders of the Company to have their shareholding in electronic form, the Company had signed the following tripartite agreements with the Depositories and the Registrar and Share Transfer Agent:

- Tripartite agreement dated March 23, 2020 with NSDL, our Company and Registrar to the Issue;
- Tripartite agreement dated September 14, 2020 with CDSL, our Company and Registrar to the Issue;
- The Company’s shares bear an ISIN: ISIN INE0D2I01014.



## **DESIGNATED DATE AND ALLOTMENT**

- (a) Our Company will ensure that the Allotment and credit to the successful Applicants' depository account will be completed within six Working Days, or such period as may be prescribed by SEBI, of the Issue Closing Date or such other period as may be prescribed.
- (b) Equity Shares will be issued and Allotment shall be made only in the dematerialised form to the Allottees.
- (c) Allottees will have the option to re-materialise the Equity Shares so allotted as per the provisions of the Companies Act, 2013 and the Depositories Act.

## **Communications**

All future communications in connection with Applications made in this Issue should be addressed to the Registrar quoting the full name of the sole or First Applicant, Application Form number, Applicants Depository Account Details, number of Equity Shares applied for, date of Application Form, name and address of the SCSB / Designated Intermediary, where the Application was submitted and bank account number in which the amount equivalent to the Application Amount was blocked.

Applicants can contact the Compliance Officer or the Registrar in case of any pre- Issue or post- Issue related problems such as non-receipt of letters of Allotment, credit of allotted shares in the respective beneficiary accounts, refund orders etc. In case of ASBA Applications submitted to the Designated Branches of the SCSBs, the Applicants can contact the Designated Branches of the SCSBs

## **Letters of Allotment or Refund Orders or Instructions to the SCSBs**

The Registrar to the Issue shall give instructions for credit to the beneficiary account with depository participants within 6 Working Days from the Issue Closing Date. The Registrar shall instruct the relevant SCSBs to, on the receipt of such instructions from the Registrar, unblock the funds in the relevant ASBA Account to the extent of the Application Amount specified in the Application Form or the relevant part thereof, for withdrawn, rejected or unsuccessful or partially successful Applications within 6 Working Days of the Issue Closing Date.

## **Mode of Refund**

Within 6 Working Days of the Issue Closing Date, the Registrar to the Issue may give instructions to SCSBs for unblocking the amount in ASBA Account on unsuccessful Application and also for any excess amount blocked on Application.

## **Interest in Case of Delay in Allotment or Refund**

The Issuer shall allot the equity shares offered to the public within the period prescribed by the Board. The Issuer may pay interest at the rate of 15% per annum in case demat credits are not made to Applicants or instructions for unblocking of funds in the ASBA Account are not dispatched within 8 Days of the Issue Closing Date.

## **Impersonation**

**Attention of the Applicants is specifically drawn to the provisions of sub-section (1) of Section 38 of the Companies Act, which is reproduced below:**

**“Any person who:**

- a) makes or abets making of an application in a fictitious name to a company for acquiring, or subscribing for, its securities; or**
- b) makes or abets making of multiple applications to a company in different names or in different combinations of his name or surname for acquiring or subscribing for its securities; or**
- c) Otherwise induces directly or indirectly a company to allot, or register any transfer of, securities to him, or to any other person in a fictitious name, shall be liable for action under Section 447”**

**The liability prescribed under Section 447 of the Companies Act, 2013 includes imprisonment for a term which shall not be less than six months extending up to 10 years (provided that where the fraud involves public interest, such term shall not be less than three years) and fine of an amount not less than the amount involved in the fraud, extending up to three times of such amount.**

#### **Undertaking by our Company**

We undertake the following:

- 1) That if our Company does not proceed with the Issue after the Issue Opening Date but before allotment, then the reason thereof shall be given as a public notice to be issued by our Company within two days of the Issue Closing Date. The public notice shall be issued in the same newspapers where the Pre- Issue advertisements were published. The stock exchanges on which the Equity Shares are proposed to be listed shall also be informed promptly;
- 2) That if our Company withdraw the Issue after the Issue Closing Date, our Company shall be required to file a fresh offer document with the RoC/SEBI, in the event our Company subsequently decides to proceed with the Issue;
- 3) That the complaints received in respect of the Issue shall be attended to by our Company expeditiously and satisfactorily;
- 4) That all steps for completion of the necessary formalities for listing and commencement of trading at all the Stock Exchanges where the Equity Shares are proposed to be listed are taken within six Working Days of the Issue Closing Date;
- 5) That where refunds (to the extent applicable) are made through electronic transfer of funds, a suitable communication shall be sent to the applicant within 8 days from the Issue Closing Date, or such time period as specified by SEBI, giving details of the bank where refunds shall be credited along with amount and expected date of electronic credit of refund;
- 6) That the Promoters' contribution in full, if applicable, shall be brought in advance before the Issue opens for subscription
- 7) That the funds required for making refunds to unsuccessful applicants as per the mode(s) disclosed shall be made available to the Registrar and Share Transfer Agent to the Issue by our Company;
- 8) That allotment is not made within the prescribed time period under applicable law; the entire subscription amount received will be refunded/ unblocked within the time prescribed under applicable law. If there is delay beyond the prescribed time, our Company shall pay interest prescribed under the Companies Act, 2013, the SEBI Regulations and applicable law for the delayed period;
- 9) That the confirmation of allotment of the securities/refund orders to Eligible NRIs shall be dispatched within specified time;
- 10) That no further Issue of Equity Shares shall be made till the Equity Shares offered through this Offer Document are listed or until the Application monies are refunded/ unblocked in the ASBA Accounts on account of non-listing, under-subscription etc; other than as disclosed in Regulation 56 of SEBI (Issue of Capital and Disclosure Requirements) Regulations, 2018.
- 11) Adequate arrangements shall be made to collect all Applications Supported by Blocked Amount and to consider them similar to non-ASBA applications while finalizing the basis of allotment; and
- 12) That our Company shall not have recourse to the Issue Proceeds until the final approval for listing and trading of the Equity Shares from all the Stock Exchanges

### **Utilization of Fresh Issue Proceeds**

The Board of Directors of our Company certifies that:

- 1) All monies received out of the Fresh Issue shall be credited/ transferred to a separate bank account other than the bank account referred to in sub section (3) of Section 40 of the Companies Act, 2013;
- 2) Details of all monies utilized out of the Fresh Issue shall be disclosed under an appropriate head in our balance sheet indicating the purpose for which such monies have been utilized under an appropriate separate head in the balance sheet of our Company indicating the purpose for which such monies have been utilised;
- 3) Details of all unutilized monies out of the Fresh Issue, if any shall be disclosed under the appropriate head in the balance sheet indicating the form in which such unutilized monies have been invested and
- 4) Our Company shall comply with the requirements of the SEBI (Listing Obligations and Disclosures Requirements) Regulations, 2015 in relation to the disclosure and monitoring of the utilization of the proceeds of the Fresh Issue to the extent applicable.

## RESTRICTIONS ON FOREIGN OWNERSHIP OF INDIAN SECURITIES

Foreign investment in Indian securities is regulated through the Industrial Policy, 1991 of the Government of India and FEMA. While the Industrial Policy, 1991 prescribes the limits and the conditions subject to which foreign investment can be made in different sectors of the Indian economy, FEMA regulates the precise manner in which such investment may be made. The Union Cabinet, as provided in the Cabinet Press Release dated May 24, 2017, has given its approval for phasing out the FIPB. Accordingly, the process for foreign direct investment (“FDI”) and approval from the Government of India will now be handled by the concerned ministries or departments, in consultation with the Department of Industrial Policy and Promotion, Ministry of Commerce and Industry, Government of India (“DIPP”), Ministry of Finance, Department of Economic Affairs, FIPB section, through a memorandum dated June 5, 2017 has notified the specific ministries handling relevant sectors.

The Government of India has from time to time made policy pronouncements on FDI through press notes and press releases. The DIPP issued the Consolidated Foreign Direct Investment Policy notified by the D/o IPP F. No. 5(1)/2017-FC-1 dated August 28, 2017, with effect from August 28, 2017 (the “FDI Policy”), which consolidates and supersedes all previous press notes, press releases and clarifications on FDI issued by the DIPP that were in force and effect prior to August 28, 2017. The Government of India proposes to update the consolidated circular on FDI Policy once every year and therefore, the FDI Policy will be valid until the DIPP issues an updated circular.

Amidst the current pandemic caused by Covid-19, the Government of India has amended the extant FDI Policy, vide Press Note No. 3 (2020 Series). The said amendment has also been made in the Foreign Exchange Management (Non-debt Instrument) Rules, 2019. As per the aforesaid amendment a non-resident entity can invest in India, subject to the FDI Policy except in those sectors/activities which are prohibited. However, an entity of a country, which shares land border with India or where the beneficial owner of an investment into India is situated in or is a citizen of any such country, can invest only under the Government route. Further, in the event of the transfer of ownership of any existing or future FDI in an entity in India, directly or indirectly, resulting in the beneficial ownership falling within this restriction/purview, such subsequent change in beneficial ownership will also require Government approval.

The transfer of shares between an Indian resident and a non-resident does not require the prior approval of the RBI, provided that (i) the activities of the investee company are under the automatic route under the FDI policy and transfer does not attract the provisions of the Takeover Regulations; (ii) the non-resident shareholding is within the sectoral limits under the FDI policy; (iii) the pricing is in accordance with the guidelines prescribed by the SEBI/RBI and (iv) documentation, reporting requirements and other conditions as may be specified by the RBI in consultation with the Central Government, are adhered for such transfers

As per the existing policy of the Government of India, OCBs cannot participate in this Issue. For details, see “*Issue Procedure*” on page no. 179 of this Prospectus.

**The Equity Shares offered in the Issue have not been and will not be registered under the U.S. Securities Act or any state securities laws in the United States, and unless so registered may not be offered or sold within the United States, except pursuant to an exemption from, or in a transaction not subject to, the registration requirements of the U.S. Securities Act and applicable state securities laws. Accordingly, such Equity Shares are being offered and sold (i) outside of the United States in offshore transactions in reliance on Regulation S under the U.S. Securities Act and the applicable laws of the jurisdiction where those offers and sales occur; and (ii) to “qualified institutional buyers” (as defined in Rule 144A under the U.S. Securities Act), pursuant to the private placement exemption set out in Section 4(a) of the U.S. Securities Act.**

**The above information is given for the benefit of the Applicants. Our Company and the Lead Manager are not liable for any amendments or modification or changes in applicable laws or regulations, which may occur after the date of this Prospectus. Applicants are advised to make their independent investigations and ensure that the number of Equity Shares Application for do not exceed the applicable limits under laws or regulations.**

## SECTION XI – MAIN PROVISIONS OF ARTICLES OF ASSOCIATION

Pursuant to the Companies Act and the SEBI ICDR Regulations, the main provisions of the Articles of Association are detailed below. Capitalised terms used in this section have the meaning given to them in the Articles of Association.

Each provision below is numbered as per the corresponding article number in the Articles of Association and defined terms herein have the meaning given to them in the Articles of Association.

### Share capital and variation of rights

#### II

1. (i) The Authorized Share Capital of the Company is as per clause V of the Memorandum of Association of the Company with all rights to the company to alter the same in any way it thinks fit.

(ii) Subject to the provisions of the Act and these Articles, the shares in the capital of the company shall be under the control of the Directors who may issue, allot or otherwise dispose of the same or any of them to such persons, in such proportion and on such terms and conditions and either at a premium or at par and at such time as they may from time to time think fit.

2. (i) Every person whose name is entered as a member in the register of members shall be entitled to receive within two months after incorporation, in case of subscribers to the memorandum or after allotment or within one month after the application for the registration of transfer or transmission or within such other period as the conditions of issue shall be provided,-

(a) One certificate for all his shares without payment of any charges; or

(b) Several certificates, each for one or more of his shares, upon payment of twenty rupees for each certificate after the first.

(ii) Every certificate shall be under the seal and shall specify the shares to which it relates and the amount paid-up thereon.

(iii) In respect of any share or shares held jointly by several persons, the company shall not be bound to issue more than one certificate, and delivery of a certificate for a share to one of several joint holders shall be sufficient delivery to all such holders

3. (i) If any share certificate be worn out, defaced, mutilated or torn or if there be no further space on the back for endorsement of transfer, then upon production and surrender thereof to the company, a new certificate may be issued in lieu thereof, and if any certificate is lost or destroyed then upon proof thereof to the satisfaction of the company and on execution of such indemnity as the company deem adequate, a new certificate in lieu thereof shall be given. Every certificate under this Article shall be issued on payment of twenty rupees for each certificate.

(ii) The provisions of Articles (2) and (3) shall mutatis mutandis apply to debentures of the company.

4. Except as required by law, no person shall be recognised by the company as holding any share upon any trust, and the company shall not be bound by, or be compelled in any way to recognise (even when having notice thereof) any equitable, contingent, future or partial interest in any share, or any interest in any fractional part of a share, or (except only as by these regulations or by law otherwise provided) any other rights in respect of any share except an absolute right to the entirety thereof in the registered holder.

5. (i) The company may exercise the powers of paying commissions conferred by sub-section (6) of section 40, provided that the rate per cent or the amount of the commission paid or agreed to be paid shall be disclosed in the manner required by that section and rules made thereunder.

(ii) The rate or amount of the commission shall not exceed the rate or amount prescribed in rules made under sub-section (6) of section 40.

(iii) The commission may be satisfied by the payment of cash or the allotment of fully or partly paid shares or partly in the one way and partly in the other.

6. (i) If at any time the share capital is divided into different classes of shares, the rights attached to any class (unless otherwise provided by the terms of issue of the shares of that class) may, subject to the provisions of section 48, and whether or not the company is being wound up, be varied with the consent in writing of the holders of three-fourths of the issued shares of that class, or with the sanction of a special resolution passed at a separate meeting of the holders of the shares of that class.

(ii) To every such separate meeting, the provisions of these regulations relating to general meetings shall mutatis mutandis apply, but so that the necessary quorum shall be at least two persons holding at least one-third of the issued shares of the class in question.

7. The rights conferred upon the holders of the shares of any class issued with preferred or other rights shall not, unless otherwise expressly provided by the terms of issue of the shares of that class, be deemed to be varied by the creation or issue of further shares ranking pari passu therewith.

8. Subject to the provisions of section 55, any preference shares may, with the sanction of an ordinary resolution, be issued on the terms that they are to be redeemed on such terms and in such manner as the company before the issue of the shares may, by special resolution, determine.

### **Lien**

9. i) The company shall have a first and paramount lien --

(a) On every share (not being a fully paid share), for all monies (whether presently payable or not) called, or payable at a fixed time, in respect of that share; and

(b) on all shares (not being fully paid shares) standing registered in the name of a single person, for all monies presently payable by him or his estate to the company:

Provided that the Board of directors may at any time declare any share to be wholly or in part exempt from the provisions of this clause.

(ii) The company's lien, if any, on a share shall extend to all dividends payable and bonuses declared from time to time in respect of such shares.

10. The company may sell, in such manner as the Board thinks fit, any shares on which the company has a lien:

Provided that no sale shall be made --

(a) Unless a sum in respect of which the lien exists is presently payable; or

(b) until the expiration of fourteen days after a notice in writing stating and demanding payment of such part of the amount in respect of which the lien exists as is presently payable, has been given to the registered holder for the time being of the share or the person entitled thereto by reason of his death or insolvency.

11. (i) To give effect to any such sale, the Board may authorise some person to transfer the shares sold to the purchaser thereof

(ii) The purchaser shall be registered as the holder of the shares comprised in any such transfer.

(iii) The purchaser shall not be bound to see to the application of the purchase money, nor shall his title to the shares be affected by any irregularity or invalidity in the proceedings in reference to the sale.

12. (i) The proceeds of the sale shall be received by the company and applied in payment of such part of the amount in respect of which the lien exists as is presently payable.

(ii) The residue, if any, shall, subject to a like lien for sums not presently payable as existed upon the shares before the sale, be paid to the person entitled to the shares at the date of the sale.

### **Calls on shares**

**13.** (i) The Board may, from time to time, make calls upon the members in respect of any monies unpaid on their shares (whether on account of the nominal value of the shares or by way of premium) and not by the conditions of allotment thereof made payable at fixed times:

Provided that no call shall exceed one-fourth of the nominal value of the share or be payable at less than one month from the date fixed for the payment of the last preceding call.

(ii) Each member shall, subject to receiving at least fourteen days' notice specifying the time or times and place of payment, pay to the company, at the time or times and place so specified, the amount called on his shares.

(iii) A call may be revoked or postponed at the discretion of the Board.

(iv) The right or option to make a call on shares cannot be delegated to anyone except with the permission of the Company in general meeting.

**14.** A call shall be deemed to have been made at the time when the resolution of the Board authorizing the call was passed and may be required to be paid by instalments.

**15.** The joint holders of a share shall be jointly and severally liable to pay all calls in respect thereof.

**16.** (i) If a sum called in respect of a share is not paid before or on the day appointed for payment thereof, the person from whom the sum is due shall pay interest thereon from the day appointed for payment thereof to the time of actual payment at ten per cent per annum or at such lower rate, if any, as the Board may determine.

(ii) The Board shall be at liberty to waive payment of any such interest wholly or in part.

**17.** (i) Any sum which by the terms of issue of a share becomes payable on allotment or at any fixed date, whether on account of the nominal value of the share or by way of premium, shall, for the purposes of these regulations, be deemed to be a call duly made and payable on the date on which by the terms of issue such sum becomes payable.

(ii) In case of non-payment of such sum, all the relevant provisions of these regulations as to payment of interest and expenses, forfeiture or otherwise shall apply as if such sum had become payable by virtue of a call duly made and notified.

**18.** The Board –

(a) may, if it thinks fit, receive from any member willing to advance the same, all or any part of the monies uncalled and unpaid upon any shares held by him; and

(b) upon all or any of the monies so advanced, may (until the same would, but for such advance, become presently payable) pay interest at such rate not exceeding, unless the company in general meeting shall otherwise direct, twelve per cent per annum, as may be agreed upon between the Board and the member paying the sum in advance but shall not confer a right to dividend or to participate in profits.

### **Transfer of shares**

**19.** (i) The instrument of transfer of any share in the company shall be executed by or on behalf of both the transferor and transferee.

(ii) The transferor shall be deemed to remain a holder of the share until the name of the transferee is entered in the register of members in respect thereof.

**20.** The Board may, subject to the right of appeal conferred by section 58 and 59 decline to register any transfer of Shares on such grounds as it think fit in the benefit of the company (notwithstanding that the proposed transferee be

already a Member), but in such case it shall, within two (2) months from the date the instrument of transfer was lodged with the Company, send to the transferee and the transferor notice of the refusal to register such transfer giving reasons for such refusal. Provided that in no case, the Board shall refuse the transfer on the ground of the transferor being either alone or jointly with any other person or persons indebted to the Issuer on any account whatsoever.

**21.** The Board may decline to recognise any instrument of transfer unless --

(a) the instrument of transfer is in the form as prescribed in rules made under sub-section (1) of section 56;

(b) the instrument of transfer is accompanied by the certificate of the shares to which it relates, and such other evidence as the Board may reasonably require to show the right of the transferor to make the transfer; and

(c) the instrument of transfer is in respect of only one class of shares.

**22.** On giving not less than seven days' previous notice in accordance with section 91 and rules made thereunder, the registration of transfers may be suspended at such times and for such periods as the Board may from time to time determine:

Provided that such registration shall not be suspended for more than thirty days at any one time or for more than forty-five days in the aggregate in any year.

Subject to the provisions of Section 59 of Companies Act, 2013, the Board may decline to register any transfer of Shares on such grounds as it think fit in the benefit of the company (notwithstanding that the proposed transferee be already a Member), but in such case it shall, within two (2) months from the date the instrument of transfer was lodged with the Company, send to the transferee and the transferor notice of the refusal to register such transfer giving reasons for such refusal.

#### **Transmission of shares**

**23.** (i) On the death of a member, the survivor or survivors where the member was a joint holder, and his nominee or nominees or legal representatives where he was a sole holder, shall be the only persons recognised by the company as having any title to his interest in the shares

(ii) Nothing in clause (i) shall release the estate of a deceased joint holder from any liability in respect of any share which had been jointly held by him with other persons.

**24.** (i) Any person becoming entitled to a share in consequence of the death or insolvency of a member may, upon such evidence being produced as may from time to time properly be required by the Board and subject as hereinafter provided, elect, either --

(a) to be registered himself as holder of the share; or

(b) to make such transfer of the share as the deceased or insolvent member could have made.

(ii) The Board shall, in either case, have the same right to decline or suspend registration as it would have had, if the deceased or insolvent member had transferred the share before his death or insolvency.

**25.** (i) If the person so becoming entitled shall elect to be registered as holder of the share himself, he shall deliver or send to the company a notice in writing signed by him stating that he so elects.

(ii) If the person aforesaid shall elect to transfer the share, he shall testify his election by executing a transfer of the share.

(iii) All the limitations, restrictions and provisions of these regulations relating to the right to transfer and the registration of transfers of shares shall be applicable to any such notice or transfer as aforesaid as if the death or insolvency of the member had not occurred and the notice or transfer were a transfer signed by that member.

**26.** A person becoming entitled to a share by reason of the death or insolvency of the holder shall be entitled to the same dividends and other advantages to which he would be entitled if he were the registered holder of the share, except



that he shall not, before being registered as a member in respect of the share, be entitled in respect of it to exercise any right conferred by membership in relation to meetings of the company:

Provided that the Board may, at any time, give notice requiring any such person to elect either to be registered himself or to transfer the share, and if the notice is not complied with within ninety days, the Board may thereafter withhold payment of all dividends, bonuses or other monies payable in respect of the share, until the requirements of the notice have been complied with.

#### **Forfeiture of shares**

**27.** If a member fails to pay any call, or installment of a call, on the day appointed for payment thereof, the Board may, at any time thereafter during such time as any part of the call or installment remains unpaid, serve a notice on him requiring payment of so much of the call or installment as is unpaid, together with any interest which may have accrued

**28.** The notice aforesaid shall --

(a) name a further day (not being earlier than the expiry of fourteen days from the date of service of the notice) on or before which the payment required by the notice is to be made; and

(b) state that, in the event of non-payment on or before the day so named, the shares in respect of which the call was made shall be liable to be forfeited.

**29.** If the requirements of any such notice as aforesaid are not complied with, any share in respect of which the notice has been given may, at any time thereafter, before the payment required by the notice has been made, be forfeited by a resolution of the Board to that effect.

**30.** (i) A forfeited share may be sold or otherwise disposed of on such terms and in such manner as the Board thinks fit.

(ii) At any time before a sale or disposal as aforesaid, the Board may cancel the forfeiture on such terms as it thinks fit.

**31.** (i) A person whose shares have been forfeited shall cease to be a member in respect of the forfeited shares, but shall, notwithstanding the forfeiture, remain liable to pay to the company all monies which, at the date of forfeiture, were presently payable by him to the company in respect of the shares.

(ii) The liability of such person shall cease if and when the company shall have received payment in full of all such monies in respect of the shares.

**32.** (i) A duly verified declaration in writing that the declarant is a director, the manager or the secretary, of the company, and that a share in the company has been duly forfeited on a date stated in the declaration, shall be conclusive evidence of the facts therein stated as against all persons claiming to be entitled to the share;

(ii) The company may receive the consideration, if any, given for the share on any sale or disposal thereof and may execute a transfer of the share in favour of the person to whom the share is sold or disposed of;

(iii) The transferee shall thereupon be registered as the holder of the share; and

(iv) The transferee shall not be bound to see to the application of the purchase money, if any, nor shall his title to the share be affected by any irregularity or invalidity in the proceedings in reference to the forfeiture, sale or disposal of the share.

**33.** The provisions of these regulations as to forfeiture shall apply in the case of non-payment of any sum which, by the terms of issue of a share, becomes payable at a fixed time, whether on account of the nominal value of the share or by way of premium, as if the same had been payable by virtue of a call duly made and notified.

#### **Alteration of capital**

**34.** The company may, from time to time, by ordinary resolution increase the share capital by such sum, to be divided into shares of such amount, as may be specified in the resolution.

**35.** Subject to the provisions of section 61, the company may, by ordinary resolution,—

- (a) consolidate and divide all or any of its share capital into shares of larger amount than its existing shares;
- (b) convert all or any of its fully paid-up shares into stock, and reconvert that stock into fully paid-up shares of any denomination;
- (c) sub-divide its existing shares or any of them into shares of smaller amount than is fixed by the memorandum;
- (d) cancel any shares which, at the date of the passing of the resolution, have not been taken or agreed to be taken by any person

**36.** Where shares are converted into stock, --

(a) the holders of stock may transfer the same or any part thereof in the same manner as, and subject to the same regulations under which, the shares from which the stock arose might before the conversion have been transferred, or as near thereto as circumstances admit:

Provided that the Board may, from time to time, fix the minimum amount of stock transferable, so, however, that such minimum shall not exceed the nominal amount of the shares from which the stock arose.

(b) the holders of stock shall, according to the amount of stock held by them, have the same rights, privileges and advantages as regards dividends, voting at meetings of the company, and other matters, as if they held the shares from which the stock arose; but no such privilege or advantage (except participation in the dividends and profits of the company and in the assets on winding up) shall be conferred by an amount of stock which would not, if existing in shares, have conferred that privilege or advantage.

(c) such of the regulations of the company as are applicable to paid-up shares shall apply to stock and the words “share” and “shareholder” in those regulations shall include “stock” and “stock-holder” respectively.

**37.** The company may, by special resolution, reduce in any manner and with, and subject to, any incident authorised and consent required by law, --

- (a) its share capital;
- (b) any capital redemption reserve account; or
- (c) any share premium account.

#### **Capitalisation of profits**

**38.** (i) The company in general meeting may, upon the recommendation of the Board, resolve --

(a) that it is desirable to capitalise any part of the amount for the time being standing to the credit of any of the company's reserve accounts, or to the credit of the, profit and loss account, or otherwise available for distribution; and

(b) that such sum be accordingly set free for distribution in the manner specified in clause (ii) amongst the members who would have been entitled thereto, if distributed by way of dividend and in the same proportions.

(ii) The sum aforesaid shall not be paid in cash but shall be applied, subject to the provision contained in clause (iii), either in or towards --

- (A) paying up any amounts for the time being unpaid on any shares held by such members respectively;
- (B) paying up in full, unissued shares of the company to be allotted and distributed, credited as fully paid-up, to and amongst such members in the proportions aforesaid;
- (C) partly in the way specified in sub-clause (A) and partly in that specified in sub-clause (B);

(D) A securities premium account and a capital redemption reserve account may, for the purposes of this regulation, be applied in the paying up of unissued shares to be issued to members of the company as fully paid bonus shares;

(E) The Board shall give effect to the resolution passed by the company in pursuance of this regulation.

39. (i) Whenever such a resolution as aforesaid shall have been passed, the Board shall --

(a) make all appropriations and applications of the undivided profits resolved to be capitalised thereby, and all allotments and issues of fully paid shares if any; and

(b) generally do all acts and things required to give effect thereto.

(ii) The Board shall have power --

(a) to make such provisions, by the issue of fractional certificates or by payment in cash or otherwise as it thinks fit, for the case of shares becoming distributable infractions; and

(b) to authorise any person to enter, on behalf of all the members entitled thereto, into an agreement with the company providing for the allotment to them respectively, credited as fully paid-up, of any further shares to which they may be entitled upon such capitalisation, or as the case may require, for the payment by the company on their behalf, by the application thereto of their respective proportions of profits resolved to be capitalised, of the amount or any part of the amounts remaining unpaid on their existing shares;

(iii) Any agreement made under such authority shall be effective and binding on such members.

#### **Buy-back of shares**

40. Notwithstanding anything contained in these articles but subject to the provisions of sections 68 to 70 and any other applicable provision of the Act or any other law for the time being in force, the company may purchase its own shares or other specified securities.

#### **General meetings**

41. All general meetings other than annual general meeting shall be called extraordinary general meeting.

42. (i) The Board may, whenever it thinks fit, call an extraordinary general meeting.

(ii) If at any time directors capable of acting who are sufficient in number to form a quorum are not within India, any director or any two members of the company may call an extraordinary general meeting in the same manner, as nearly as possible, as that in which such a meeting may be called by the Board.

#### **Proceedings at general meetings**

43. (i) No business shall be transacted at any general meeting unless a quorum of members is present at the time when the meeting proceeds to business.

(ii) Save as otherwise provided herein, the quorum for the general meetings shall be as provided in section 103.

44. The chairperson, if any, of the Board shall preside as Chairperson at every general meeting of the company.

45. If there is no such Chairperson, or if he is not present within fifteen minutes after the time appointed for holding the meeting, or is unwilling to act as chairperson of the meeting, the directors present shall elect one of their members to be Chairperson of the meeting.

46. If at any meeting no director is willing to act as Chairperson or if no director is present within fifteen minutes after the time appointed for holding the meeting, the members present shall choose one of their members to be Chairperson of the meeting.

### **Adjournment of meeting**

47. (i) The Chairperson may, with the consent of any meeting at which a quorum is present, and shall, if so directed by the meeting, adjourn the meeting from time to time and from place to place.

(ii) No business shall be transacted at any adjourned meeting other than the business left unfinished at the meeting from which the adjournment took place.

(iii) When a meeting is adjourned for thirty days or more, notice of the adjourned meeting shall be given as in the case of an original meeting.

(iv) Save as aforesaid, and as provided in section 103 of the Act, it shall not be necessary to give any notice of an adjournment or of the business to be transacted at an adjourned meeting.

### **Voting rights**

48. Subject to any rights or restrictions for the time being attached to any class or classes of shares, --

(a) on a show of hands, every member present in person shall have one vote; and

(b) on a poll, the voting rights of members shall be in proportion to his share in the paid-up equity share capital of the company.

49. A member may exercise his vote at a meeting by electronic means in accordance with section 108 and shall vote only once.

50. (i) In the case of joint holders, the vote of the senior who tenders a vote, whether in person or by proxy, shall be accepted to the exclusion of the votes of the other joint holders.

(ii) For this purpose, seniority shall be determined by the order in which the names stand in the register of members.

51. A member of unsound mind, or in respect of whom an order has been made by any court having jurisdiction in lunacy, may vote, whether on a show of hands or on a poll, by his committee or other legal guardian, and any such committee or guardian may, on a poll, vote by proxy.

52. Any business other than that upon which a poll has been demanded may be proceeded with, pending the taking of the poll.

53. No member shall be entitled to vote at any general meeting unless all calls or other sums presently payable by him in respect of shares in the company have been paid

54. (i) No objection shall be raised to the qualification of any voter except at the meeting or adjourned meeting at which the vote objected to is given or tendered, and every vote not disallowed at such meeting shall be valid for all purposes.

(ii) Any such objection made in due time shall be referred to the Chairperson of the meeting, whose decision shall be final and conclusive.

### **Proxy**

55. The instrument appointing a proxy and the power-of-attorney or other authority, if any, under which it is signed or a notarised copy of that power or authority, shall be deposited at the registered office of the company not less than 48 hours before the time for holding the meeting or adjourned meeting at which the person named in the instrument proposes to vote, or, in the case of a poll, not less than 24 hours before the time appointed for the taking of the poll; and in default the instrument of proxy shall not be treated as valid.

56. An instrument appointing a proxy shall be in the form as prescribed in the rules made under section 105

57. A vote given in accordance with the terms of an instrument of proxy shall be valid, notwithstanding the previous death or insanity of the principal or the revocation of the proxy or of the authority under which the proxy was executed, or the transfer of the shares in respect of which the proxy is given:

Provided that no intimation in writing of such death, insanity, revocation or transfer shall have been received by the company at its office before the commencement of the meeting or adjourned meeting at which the proxy is used.

### **Board of Directors**

58. The First Directors of the Company are:

1. Ms. Leena Kamat
2. Mr. Rajkumar Kamat
3. Ms. Nimisha Kamat

The Number of Directors of the company not less than 3 and not more than 15.

59. (i) The remuneration of the directors shall, in so far as it consists of a monthly payment, be deemed to accrue from day-to-day.

(ii) In addition to the remuneration payable to them in pursuance of the Act, the directors may be paid all travelling, hotel and other expenses properly incurred by them --

(a) in attending and returning from meetings of the Board of Directors or any committee thereof or general meetings of the company; or

(b) in connection with the business of the company.

60. The Board may pay all expenses incurred in getting up and registering the company.

61. The company may exercise the powers conferred on it by section 88 with regard to the keeping of a foreign register; and the Board may (subject to the provisions of that section) make and vary such regulations as it may think fit respecting the keeping of any such register.

62. All cheques, promissory notes, drafts, hundis, bills of exchange and other negotiable instruments, and all receipts for monies paid to the company, shall be signed, drawn, accepted, endorsed, or otherwise executed, as the case may be, by such person and in such manner as the Board shall from time to time by resolution determine

63. Every director present at any meeting of the Board or of a committee thereof shall sign his name in a book to be kept for that purpose.

64. (i) Subject to the provisions of section 149, the Board shall have power at any time, and from time to time, to appoint a person as an additional director, provided the number of the directors and additional directors together shall not at any time exceed the maximum strength fixed for the Board by the articles.

(ii) Such person shall hold office only up to the date of the next annual general meeting of the company but shall be eligible for appointment by the company as a director at that meeting subject to the provisions of the Act.

### **Proceedings of the Board**

65. (i) The Board of Directors may meet for the conduct of business, adjourn and otherwise regulate its meetings, as it thinks fit.

(ii) A director may, and the manager or secretary on the requisition of a director shall, at any time, summon a meeting of the Board.

66. (i) Save as otherwise expressly provided in the Act, questions arising at any meeting of the Board shall be decided by a majority of votes.

(ii) In case of an equality of votes, the Chairperson of the Board, if any, shall have a second or casting vote.

**67.** The continuing directors may act notwithstanding any vacancy in the Board; but, if and so long as their number is reduced below the quorum fixed by the Act for a meeting of the Board, the continuing directors or director may act for the purpose of increasing the number of directors to that fixed for the quorum, or of summoning a general meeting of the company, but for no other purpose.

**68.** (i) The Board may elect a Chairperson of its meetings and determine the period for which he is to hold office.

(ii) If no such Chairperson is elected, or if at any meeting the Chairperson is not present within five minutes after the time appointed for holding the meeting, the directors present may choose one of their numbers to be Chairperson of the meeting.

**69.** (i) The Board may, subject to the provisions of the Act, delegate any of its powers to committees consisting of such member or members of its body as it thinks fit.

(ii) Any committee so formed shall, in the exercise of the powers so delegated, conform to any regulations that may be imposed on it by the Board.

**70.** (i) A committee may elect a Chairperson of its meetings.

(ii) If no such Chairperson is elected, or if at any meeting the Chairperson is not present within five minutes after the time appointed for holding the meeting, the members present may choose one of their members to be Chairperson of the meeting.

**71.** (i) A committee may meet and adjourn as it thinks fit.

(ii) Questions arising at any meeting of a committee shall be determined by a majority of votes of the members present, and in case of an equality of votes, the Chairperson shall have a second or casting vote.

**72.** All acts done in any meeting of the Board or of a committee thereof or by any person acting as a director, shall, notwithstanding that it may be afterwards discovered that there was some defect in the appointment of any one or more of such directors or of any person acting as aforesaid, or that they or any of them were disqualified, be as valid as if every such director or such person had been duly appointed and was qualified to be a director

**73.** Save as otherwise expressly provided in the Act, a resolution in writing, signed by all the members of the Board or of a committee thereof, for the time being entitled to receive notice of a meeting of the Board or committee, shall be valid and effective as if it had been passed at a meeting of the Board or committee, duly convened and held.

#### **Chief Executive Officer, Manager, Company Secretary or Chief Financial Officer**

**74.** Subject to the provisions of the Act, --

(i) A chief executive officer, manager, company secretary or chief financial officer may be appointed by the Board for such term, at such remuneration and upon such conditions as it may think fit; and any chief executive officer, manager, company secretary or chief financial officer so appointed may be removed by means of a resolution of the Board;

(ii) A director may be appointed as chief executive officer, manager, company secretary or chief financial officer

**75.** A provision of the Act or these regulations requiring or authorising a thing to be done by or to a director and chief executive officer, manager, company secretary or chief financial officer shall not be satisfied by its being done by or to the same person acting both as director and as, or in place of, chief executive officer, manager, company secretary or chief financial officer.

## **The Seal**

**76.** (i) The Board shall provide for the safe custody of the seal.

(ii) The seal of the company shall not be affixed to any instrument except by the authority of a resolution of the Board or of a committee of the Board authorised by it in that behalf, and except in the presence of at least two directors and of the secretary or such other person as the Board may appoint for the purpose; and those two directors and the secretary or other person aforesaid shall sign every instrument to which the seal of the company is so affixed in their presence.

## **Dividends and Reserve**

**77.** The company in general meeting may declare dividends, but no dividend shall exceed the amount recommended by the Board.

**78.** Subject to the provisions of section 123, the Board may from time to time pay to the members such interim dividends as appear to it to be justified by the profits of the company.

**79.** (i) The Board may, before recommending any dividend, set aside out of the profits of the company such sums as it thinks fit as a reserve or reserves which shall, at the discretion of the Board, be applicable for any purpose to which the profits of the company may be properly applied, including provision for meeting contingencies or for equalizing dividends; and pending such application, may, at the like discretion, either be employed in the business of the company or be invested in such investments (other than shares of the company) as the Board may, from time to time, think fit.

(ii) The Board may also carry forward any profits which it may consider necessary not to divide, without setting them aside as a reserve

**80.** (i) Subject to the rights of persons, if any, entitled to shares with special rights as to dividends, all dividends shall be declared and paid according to the amounts paid or credited as paid on the shares in respect whereof the dividend is paid, but if and so long as nothing is paid upon any of the shares in the company, dividends may be declared and paid according to the amounts of the shares.

(ii) No amount paid or credited as paid on a share in advance of calls shall be treated for the purposes of this regulation as paid on the share.

(iii) All dividends shall be apportioned and paid proportionately to the amounts paid or credited as paid on the shares during any portion or portions of the period in respect of which the dividend is paid; but if any share is issued on terms providing that it shall rank for dividend as from a particular date such share shall rank for dividend accordingly.

**81.** The Board may deduct from any dividend payable to any member all sums of money, if any, presently payable by him to the company on account of calls or otherwise in relation to the shares of the company.

**82.** (i) Any dividend, interest or other monies payable in cash in respect of shares may be paid by cheque or warrant sent through the post directed to the registered address of the holder or, in the case of joint holders, to the registered address of that one of the joint holders who is first named on the register of members, or to such person and to such address as the holder or joint holders may in writing direct.

(ii) Every such cheque or warrant shall be made payable to the order of the person to whom it is sent.

**83.** Any one of two or more joint holders of a share may give effective receipts for any dividends, bonuses or other monies payable in respect of such share.

**84.** Notice of any dividend that may have been declared shall be given to the persons entitled to share therein in the manner mentioned in the Act.

**85.** No dividend shall bear interest against the company.

No unclaimed Dividend shall be forfeited before the claim becomes barred by law, and unclaimed Dividends shall be dealt with in accordance with the applicable provisions of the Act

### **Accounts**

**86.** (i) The Board shall from time to time determine whether and to what extent and at what times and places and under what conditions or regulations, the accounts and books of the company, or any of them, shall be open to the inspection of members not being directors.

(ii) No member (not being a director) shall have any right of inspecting any account or book or document of the company except as conferred by law or authorised by the Board or by the company in general meeting.

### **Winding up**

**87.** Subject to the provisions of Chapter XX of the Act and rules made thereunder --

(i) If the company shall be wound up, the liquidator may, with the sanction of a special resolution of the company and any other sanction required by the Act, divide amongst the members, in specie or kind, the whole or any part of the assets of the company, whether they shall consist of property of the same kind or not.

(ii) For the purpose aforesaid, the liquidator may set such value as he deems fair upon any property to be divided as aforesaid and may determine how such division shall be carried out as between the members or different classes of members.

(iii) The liquidator may, with the like sanction, vest the whole or any part of such assets in trustees upon such trusts for the benefit of the contributories if he considers necessary, but so that no member shall be compelled to accept any shares or other securities whereon there is any liability.

### **Indemnity**

**88.** Every officer of the company shall be indemnified out of the assets of the company against any liability incurred by him in defending any proceedings, whether civil or criminal, in which judgment is given in his favour or in which he is acquitted or in which relief is granted to him by the court or the Tribunal.

### **Further issue of capital**

(1) The Board or the Company, as the case may be, may, in accordance with the Act and the Rules, issue further shares to –

(a) persons who, at the date of offer, are holders of equity shares of the Company; such offer shall be deemed to include a right exercisable by the person concerned to renounce the shares offered to him or any of them in favour of any other person; or

(b) employees under any scheme of employees' stock option; or

(c) any persons, whether or not those persons include the persons referred to in clause (a) or clause (b) above.

(2) A further issue of shares may be made in any manner whatsoever as including by way of preferential offer or private placement, subject to and the Rules and SEB guidelines

### **Dematerialisation of Securities**

(i) For the purpose of this Article:-

**"Beneficial Owner"**: Beneficial Owner shall have the meaning assigned thereto in section 2(1)(a) of the Depositories Act, 1996.

**"Depositories Act"**: Depositories Act shall mean the Depositories Act, 1996 and includes any statutory modification or re-enactment thereof for the time being in force.

**"Depository"**: Depository shall mean a Depository as defined in section 2(1) (e) of the Depositories Act, 1996.



**"Member"**: Member shall mean a duly registered holder from time to time of the security of the company and includes every person whose name is entered as beneficial owner in the records of the Depository.

**"Security"**: Security shall mean such security as may be specified by SEBI.

**"Dematerialisation of Securities"**: Notwithstanding anything on the contrary contained in this Article, the company shall be entitled to dematerialise its securities and to offer securities in a dematerialised form and further to rematerialise the securities held on depository pursuant to the Depositories Act, 1996 or any amendment thereof.

**"Option to hold securities in physical form or with depository"**: Every person holding securities of the company through allotment or otherwise shall have the option to receive and hold the same in the dematerialised form with a depository.

**"Beneficial Owner may opt out of a Depository"**: Every person holding securities of the company with a depository, being the beneficial owner thereof, may at any time opt out of the depository in the manner provided under the provisions of the Depositories Act and the Rules, if any, prescribed there under and on fulfilment of the conditions prescribed by the company from time to time, company shall issue the relevant security certificates to the beneficial owner thereof.

**"Securities in Depositories to be in fungible form"**: All securities held by a depository shall be dematerialised and shall be in fungible form. Nothing contained in Sections 153, 153A, 153B, 187B, 187C and 372A of the Companies Act, shall apply to a depository in respect of the securities held by it on behalf of the beneficial owners.

**"Rights of depository and beneficial owners"**: A depository shall be deemed to be the registered owner for the purposes of affecting the transfer of ownership of securities on behalf of the beneficial owners and shall not have any voting rights or any other rights in respect of the securities held by it.

Every person holding securities of the Company and whose name is entered as the beneficial owner in the records of the depository shall be deemed to be a member of the Company. The beneficial owner of securities shall be entitled to all rights and benefits and be subject to all the liabilities in respect of his/her securities, which are held by a depository.

**"Transfer of securities"**: Transfer of security held in a depository will be governed by the provisions of the Depository Act, 1996. Nothing contained in Section 56 of the Companies Act, 2013 or these Articles shall apply to a transfer of securities effected by a transferor and transferee both of whom are entered as beneficial owners in the records of a depository.

**"Register and Index of beneficial owners"**: The Register and Index of beneficial owners maintained by a depository under the Depositories Act, 1996 shall be deemed to be the Register and Index of Members and Security holders for the purpose of these Articles.

**"Other matters"**: Notwithstanding anything contained in these Articles, the provision of Depositories Act, 1996 relating to dematerialisation of securities including any modification(s) or re-enactment thereof and Rules/Regulations made there under shall prevail accordingly.

Notwithstanding anything contained in the Act or the Articles, where securities are held in a depository, the records of the beneficial ownership may be served by such depository on the company by means of electronic mode or by delivery of floppies or disks.

## SECTION XII – OTHER INFORMATION

### MATERIAL CONTRACTS AND DOCUMENTS FOR INSPECTION

The copies of the following contracts which have been entered or are to be entered into by our Company (not being contracts entered into in the ordinary course of business carried on by our Company or contracts entered into more than two years before the date of this Prospectus) which are or may be deemed material will be attached to the copy of the Prospectus which will be delivered to the RoC for registration. Copies of the above mentioned contracts and also the documents for inspection referred to here under, may be inspected at the Corporate Office between 10 a.m. and 5 p.m. on all Working Days from Application/Offer Opening Date until the Application/Offer Closing Date.

#### A. Material Contracts

- 1) Memorandum of Understanding dated January 21, 2022 and Addendum dated June 02, 2022 between our Company and the Lead Manager.
- 2) Memorandum of Understanding dated January 27, 2022 between our Company and the Registrar to the Issue.
- 3) Escrow Agreement dated June 06, 2022 between our Company, the Lead Manager, Escrow Collection Bank(s) / Sponsor Bank and the Registrar to the Issue.
- 4) Market Making Agreement dated March 09, 2022 and Addendum dated June 02, 2022 between our Company, the Lead Manager and Market Maker.
- 5) Underwriting Agreement dated March 09, 2022 and Addendum dated June 02, 2022 between our Company, the Lead Manager and the Market Maker.
- 6) Tripartite agreement between the CDSL, our Company and the Registrar to the Issue dated September 14, 2020
- 7) Tripartite agreement between the NSDL, our Company and the Registrar to the Issue dated March 23, 2020.

#### B. Material Documents

- 1) Certified true copies of the updated Memorandum and Articles of Association of our Company, as amended from time to time.
- 2) Copy of Certificate of Incorporation dated January 17, 2020 issued under the name EP Biocomposites Limited by Registrar of Companies.
- 3) Resolution of the Board of Directors dated January 7, 2022 in relation to the Issue.
- 4) Resolution of the Shareholders of our Company, passed at the Extra Ordinary General Meeting held with a shorter notice on January 10, 2022 in relation to the Issue.
- 5) Statutory Auditor's report for Restated Financials dated June 06, 2022 included in this Prospectus.
- 6) The Statement of Tax Benefits dated June 06, 2022 from our Statutory Auditors included in this Prospectus.
- 7) Consents of our Directors, Company Secretary and Compliance Officer, Chief Financial Officer, Statutory Auditor, Banker(s) to the Company, Lead Manager, Legal Advisor to the Issue, Registrar to the Issue, Banker to the Issue, Underwriters and Market Maker to act in their respective capacities.
- 8) Due Diligence Certificate(s) dated August 23, 2022 to SEBI by the Lead Manager.
- 9) Approval from BSE vide letter dated March 10, 2022 to use the name of BSE in this Offer Document for listing of Equity Shares on the SME Platform of the BSE Limited.

## **DECLARATION**

We, hereby declare that, all the relevant provisions of the Companies Act, 2013 (to the extent notified) and the Guidelines issued by the Government of India or the Regulations or Guidelines issued by the Securities and Exchange Board of India, as the case may be, have been complied with and no statement made in the Prospectus is contrary to the provisions of the Companies Act, 2013 (to the extent notified), the Securities and Exchange Board of India Act, 1992, each as Amended or Rules made there under or Guidelines / Regulations issued, as the case may be. We further certify that all the disclosures and statements made in the Prospectus are true and correct.

**SIGNED BY THE DIRECTOR OF OUR COMPANY:**

---

**Rajkumar Kamat**  
Managing Director

**Date:** August 23, 2022

**Place:** Goa

## **DECLARATION**

We, hereby declare that, all the relevant provisions of the Companies Act, 2013 (to the extent notified) and the Guidelines issued by the Government of India or the Regulations or Guidelines issued by the Securities and Exchange Board of India, as the case may be, have been complied with and no statement made in the Prospectus is contrary to the provisions of the Companies Act, 2013 (to the extent notified), the Securities and Exchange Board of India Act, 1992, each as Amended or Rules made there under or Guidelines / Regulations issued, as the case may be. We further certify that all the disclosures and statements made in the Prospectus are true and correct.

**SIGNED BY THE DIRECTOR OF OUR COMPANY:**

---

**Shreyas Nadkarni**  
Executive Director

**Date:** August 23, 2022

**Place:** Goa

## DECLARATION

We, hereby declare that, all the relevant provisions of the Companies Act, 2013 (to the extent notified) and the Guidelines issued by the Government of India or the Regulations or Guidelines issued by the Securities and Exchange Board of India, as the case may be, have been complied with and no statement made in the Prospectus is contrary to the provisions of the Companies Act, 2013 (to the extent notified), the Securities and Exchange Board of India Act, 1992, each as Amended or Rules made there under or Guidelines / Regulations issued, as the case may be. We further certify that all the disclosures and statements made in the Prospectus are true and correct.

**SIGNED BY THE DIRECTOR OF OUR COMPANY:**

---

**Leena Kamat**

Non-Executive Director

**Date:** August 23, 2022

**Place:** Goa

## **DECLARATION**

We, hereby declare that, all the relevant provisions of the Companies Act, 2013 (to the extent notified) and the Guidelines issued by the Government of India or the Regulations or Guidelines issued by the Securities and Exchange Board of India, as the case may be, have been complied with and no statement made in the Prospectus is contrary to the provisions of the Companies Act, 2013 (to the extent notified), the Securities and Exchange Board of India Act, 1992, each as Amended or Rules made there under or Guidelines / Regulations issued, as the case may be. We further certify that all the disclosures and statements made in the Prospectus are true and correct.

### **SIGNED BY THE DIRECTOR OF OUR COMPANY:**

---

**Nitin Kunkolienker**

Non-Executive Independent Director

**Date:** August 23, 2022

**Place:** Goa

## **DECLARATION**

We, hereby declare that, all the relevant provisions of the Companies Act, 2013 (to the extent notified) and the Guidelines issued by the Government of India or the Regulations or Guidelines issued by the Securities and Exchange Board of India, as the case may be, have been complied with and no statement made in the Prospectus is contrary to the provisions of the Companies Act, 2013 (to the extent notified), the Securities and Exchange Board of India Act, 1992, each as Amended or Rules made there under or Guidelines / Regulations issued, as the case may be. We further certify that all the disclosures and statements made in the Prospectus are true and correct.

### **SIGNED BY THE DIRECTOR OF OUR COMPANY:**

\_\_\_\_\_  
**Dinesh Shenoy**  
Non-Executive Independent Director

**Date:** August 23, 2022

**Place:** Goa

## **DECLARATION**

We, hereby declare that, all the relevant provisions of the Companies Act, 2013 (to the extent notified) and the Guidelines issued by the Government of India or the Regulations or Guidelines issued by the Securities and Exchange Board of India, as the case may be, have been complied with and no statement made in the Prospectus is contrary to the provisions of the Companies Act, 2013 (to the extent notified), the Securities and Exchange Board of India Act, 1992, each as Amended or Rules made there under or Guidelines / Regulations issued, as the case may be. We further certify that all the disclosures and statements made in the Prospectus are true and correct.

### **SIGNED BY THE CHIEF FINANCIAL OFFICER:**

\_\_\_\_\_  
**Nilam Naresh Kadkade**  
Chief Financial Officer

**Date:** August 23, 2022

**Place:** Goa



## **DECLARATION**

We, hereby declare that, all the relevant provisions of the Companies Act, 2013 (to the extent notified) and the Guidelines issued by the Government of India or the Regulations or Guidelines issued by the Securities and Exchange Board of India, as the case may be, have been complied with and no statement made in the Prospectus is contrary to the provisions of the Companies Act, 2013 (to the extent notified), the Securities and Exchange Board of India Act, 1992, each as Amended or Rules made there under or Guidelines / Regulations issued, as the case may be. We further certify that all the disclosures and statements made in the Prospectus are true and correct.

**SIGNED BY THE COMPANY SECRETARY & COMPLIANCE OFFICER:**

**Mohammad Faiyazul Haq**  
Company Secretary & Compliance Officer

**Date:** August 23, 2022

**Place:** Goa